



US00D390912S

# United States Patent [19] Smith

[11] Patent Number: **Des. 390,912**  
[45] Date of Patent: **\*\*Feb. 17, 1998**

## [54] SPRINKLER

[76] Inventor: **Cyr W. Smith**, W3297 County Rd. J.,  
Green Lake, Wis. 54941

[\*\*] Term: **14 Years**

[21] Appl. No.: **70,745**

[22] Filed: **Apr. 8, 1997**

[51] LOC (6) Cl. .... **23-01**

[52] U.S. Cl. .... **D23/214**

[58] Field of Search ..... D23/213-215,  
D23/219, 217, 201; 239/200-206, 211,  
276

## [56] References Cited

### U.S. PATENT DOCUMENTS

D. 164,770	10/1951	Griswold .....	D23/215
D. 180,472	6/1957	Cowen .....	D23/201
211,876	2/1879	Wolff et al. .	
D. 225,328	12/1972	Margrill .....	D23/214
D. 232,088	7/1974	Margrill .....	D23/201
1,758,767	5/1930	Taggart .....	D23/214
2,670,992	3/1954	Long .....	239/211
2,937,812	5/1960	Cook .....	239/211
4,498,627	2/1985	Arginsky .....	D23/214
5,022,588	6/1991	Haase .....	239/211

## OTHER PUBLICATIONS

Copy of catalogue page, L. Wolff Manufacturing Co., date unknown but prior to 1996.

Business card, J. Oldani, date unknown but prior to 1996, illustrating prior sprinkler design (circle).

Photographs of Oldani sprinkler design, date unknown but prior to 1996.

*Primary Examiner*—Alan P. Douglas

*Assistant Examiner*—Robin V. Taylor

*Attorney, Agent, or Firm*—DeWitt Ross & Stevens S.C.

## [57] CLAIM

The ornamental design for a sprinkler, as shown and described.

## DESCRIPTION

FIG. 1 is a perspective view of a sprinkler showing my design;

FIG. 2 is a front elevational view thereof;

FIG. 3 is a right side elevational view thereof;

FIG. 4 is a rear elevational view thereof;

FIG. 5 is a left side elevational view thereof;

FIG. 6 is a bottom plan view thereof; and,

FIG. 7 is a top plan view thereof.

The broken line showing of wires in FIGS. 1-7 and a sprinkler base in FIG. 1 are for illustrative purposes only and forms no part of the claimed design.

**1 Claim, 2 Drawing Sheets**

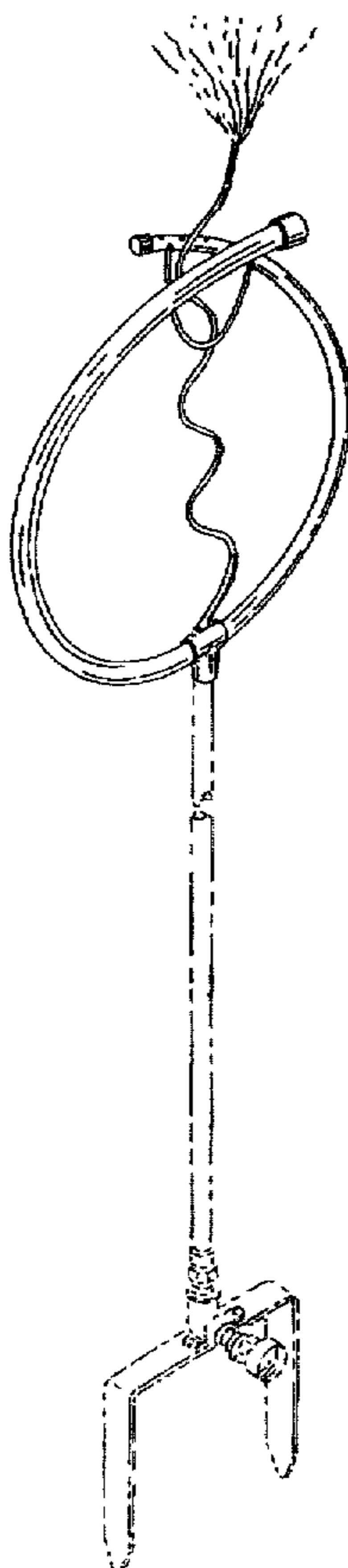

FIG. 1

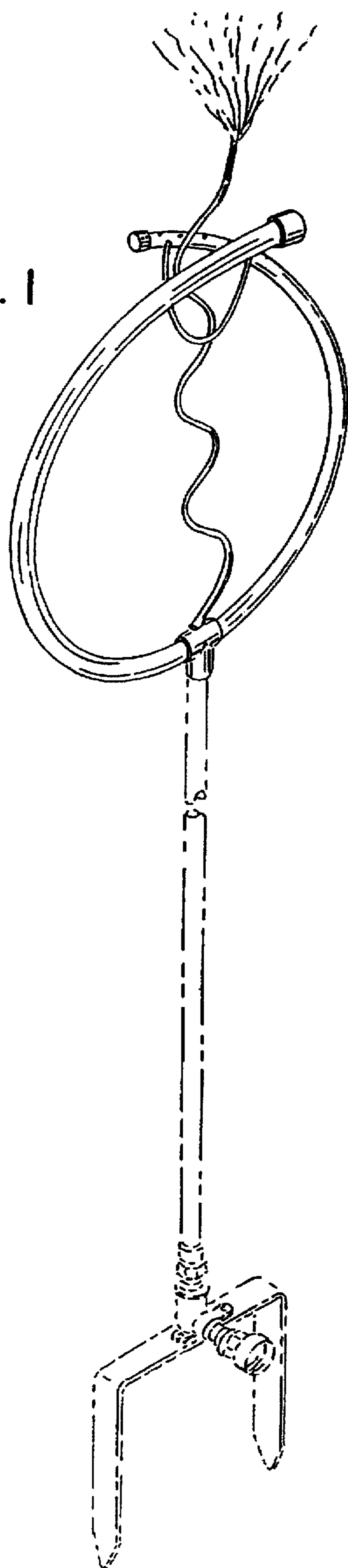

FIG. 6

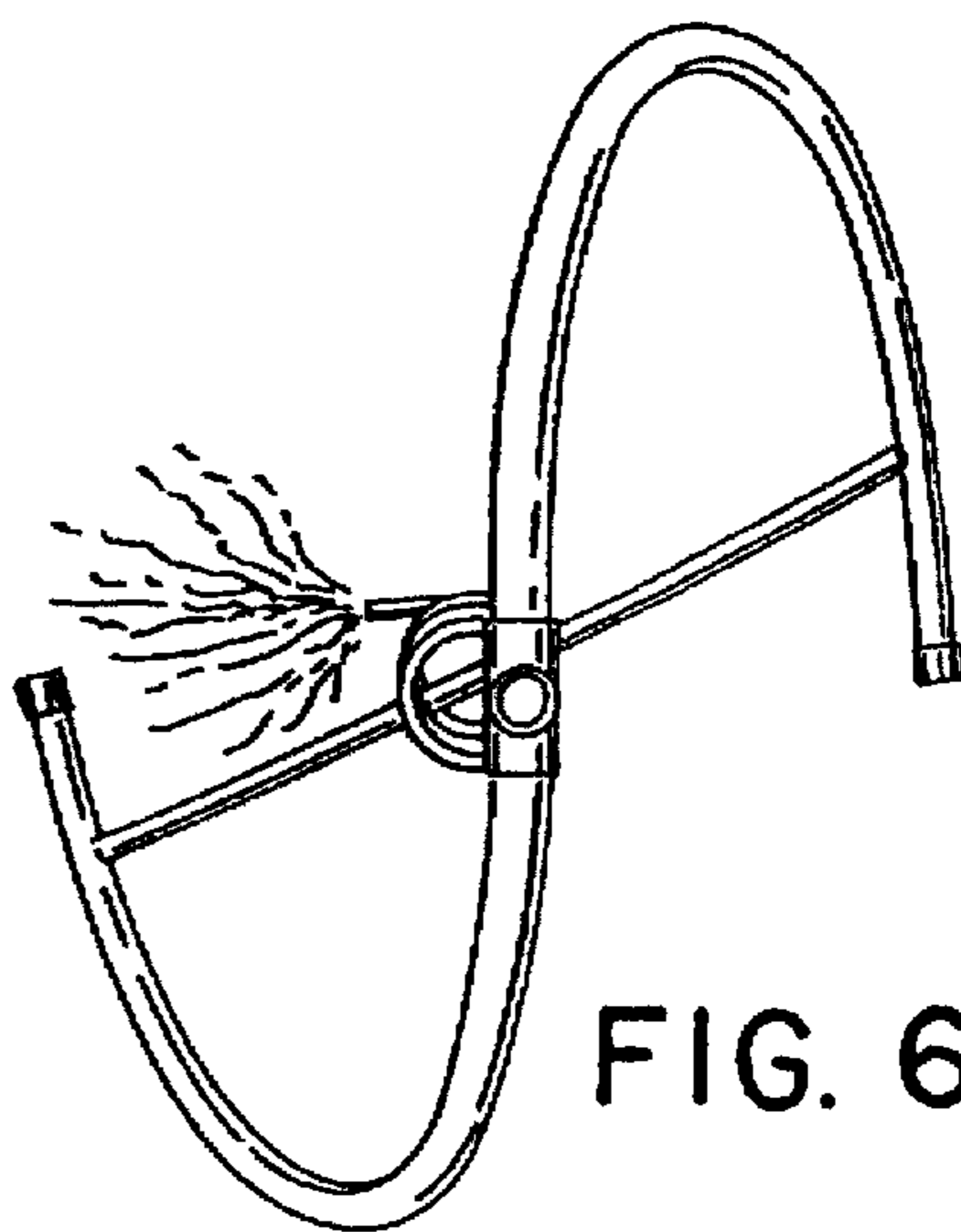
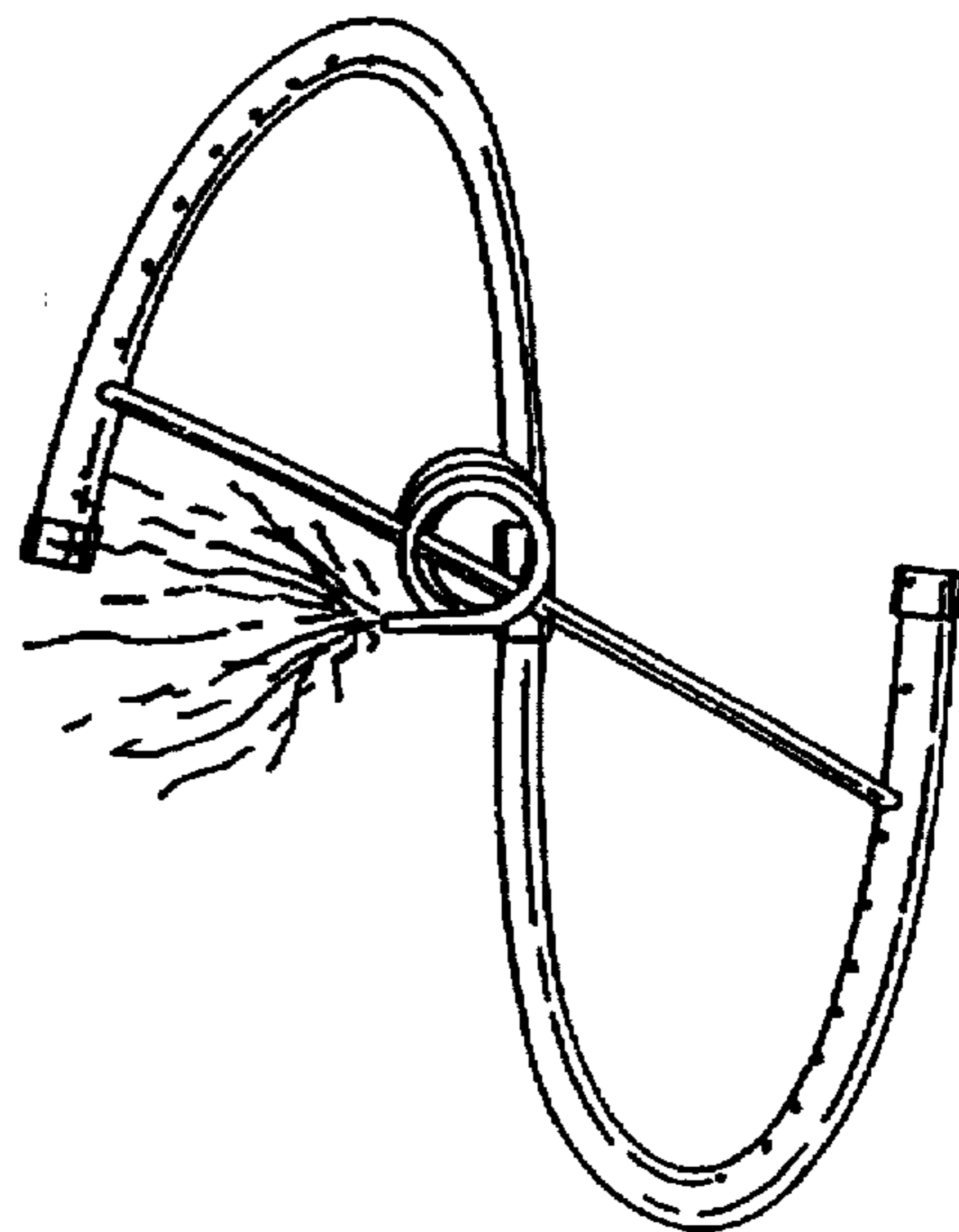

FIG. 7



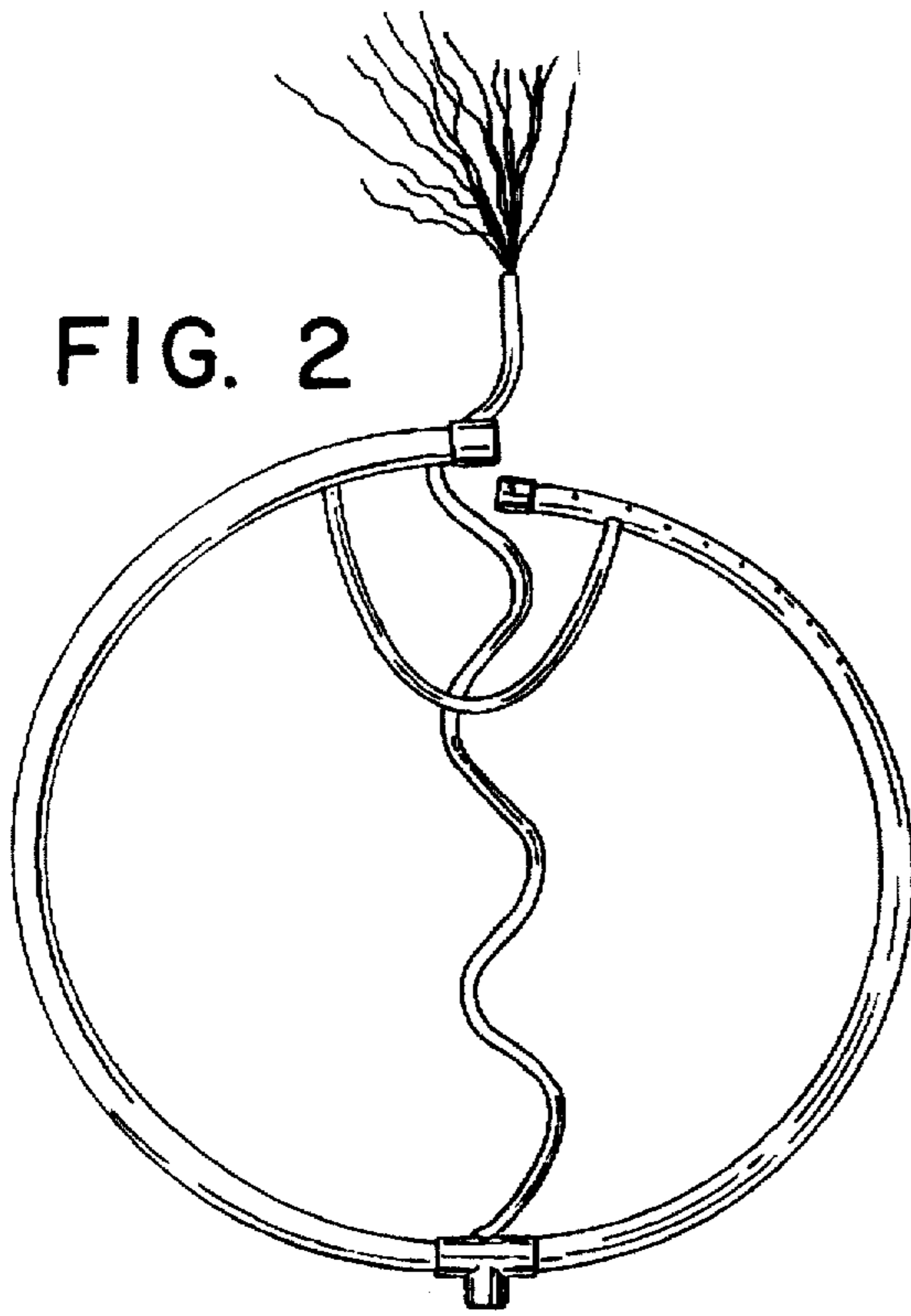

FIG. 2

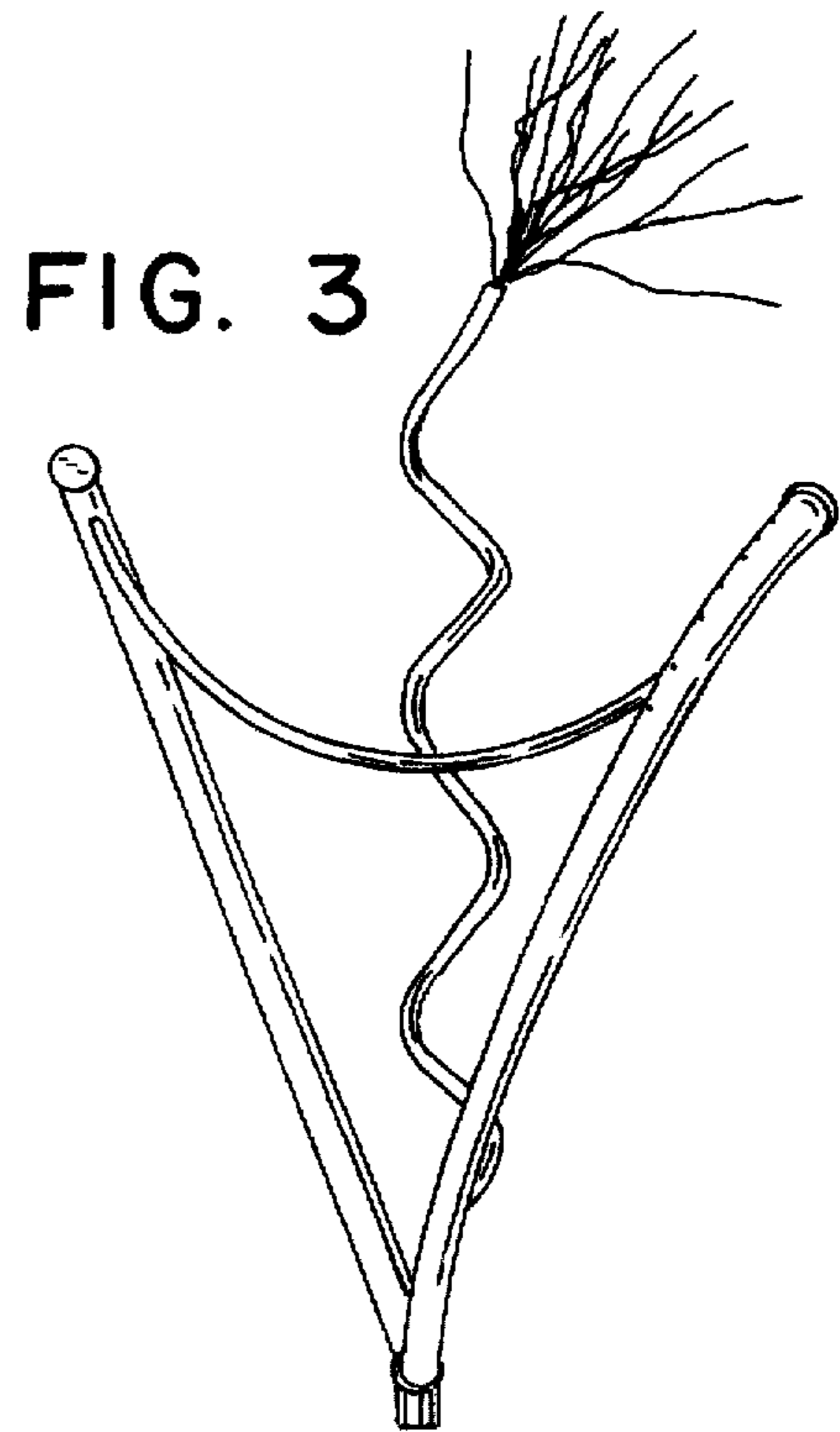

FIG. 3

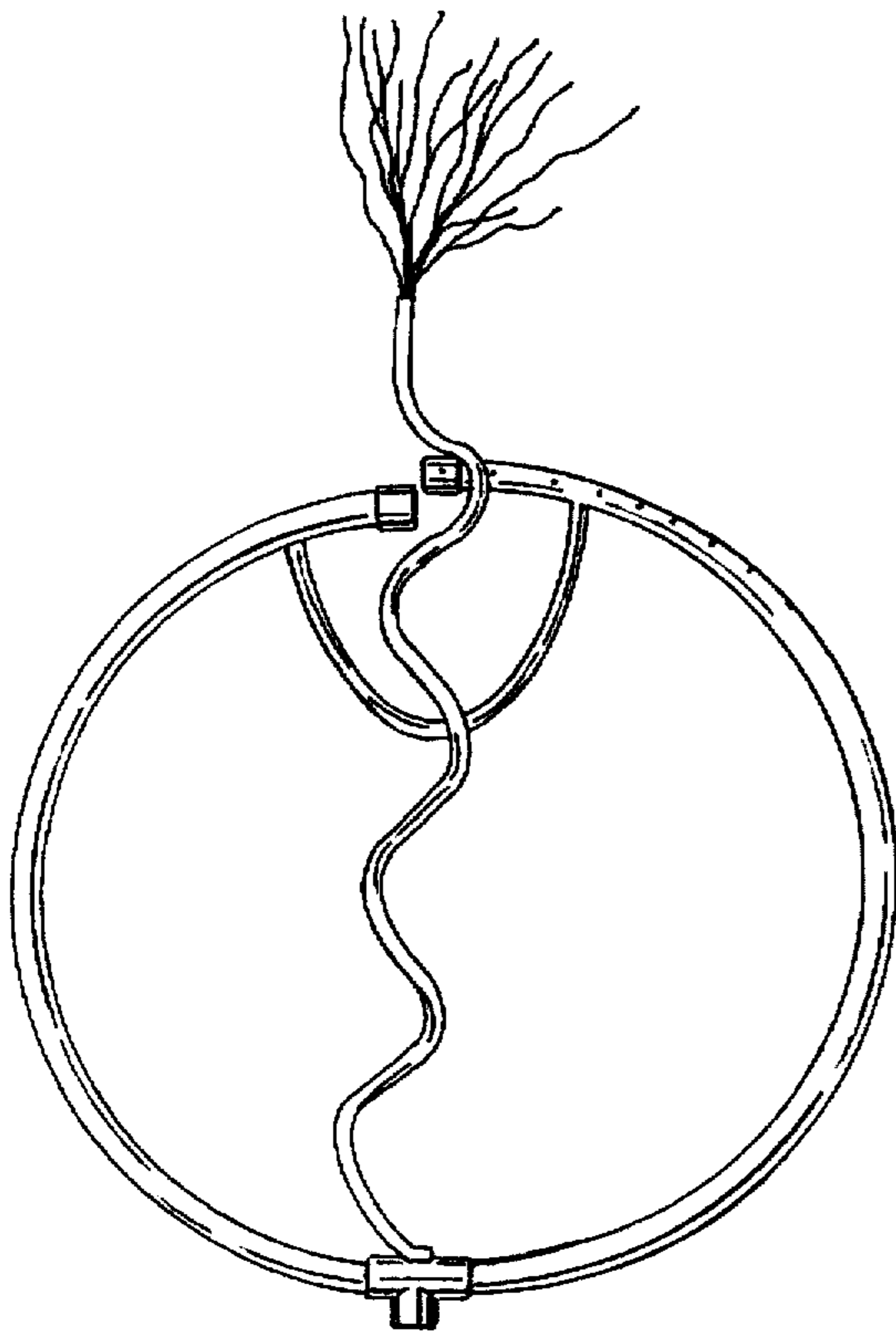

FIG. 4

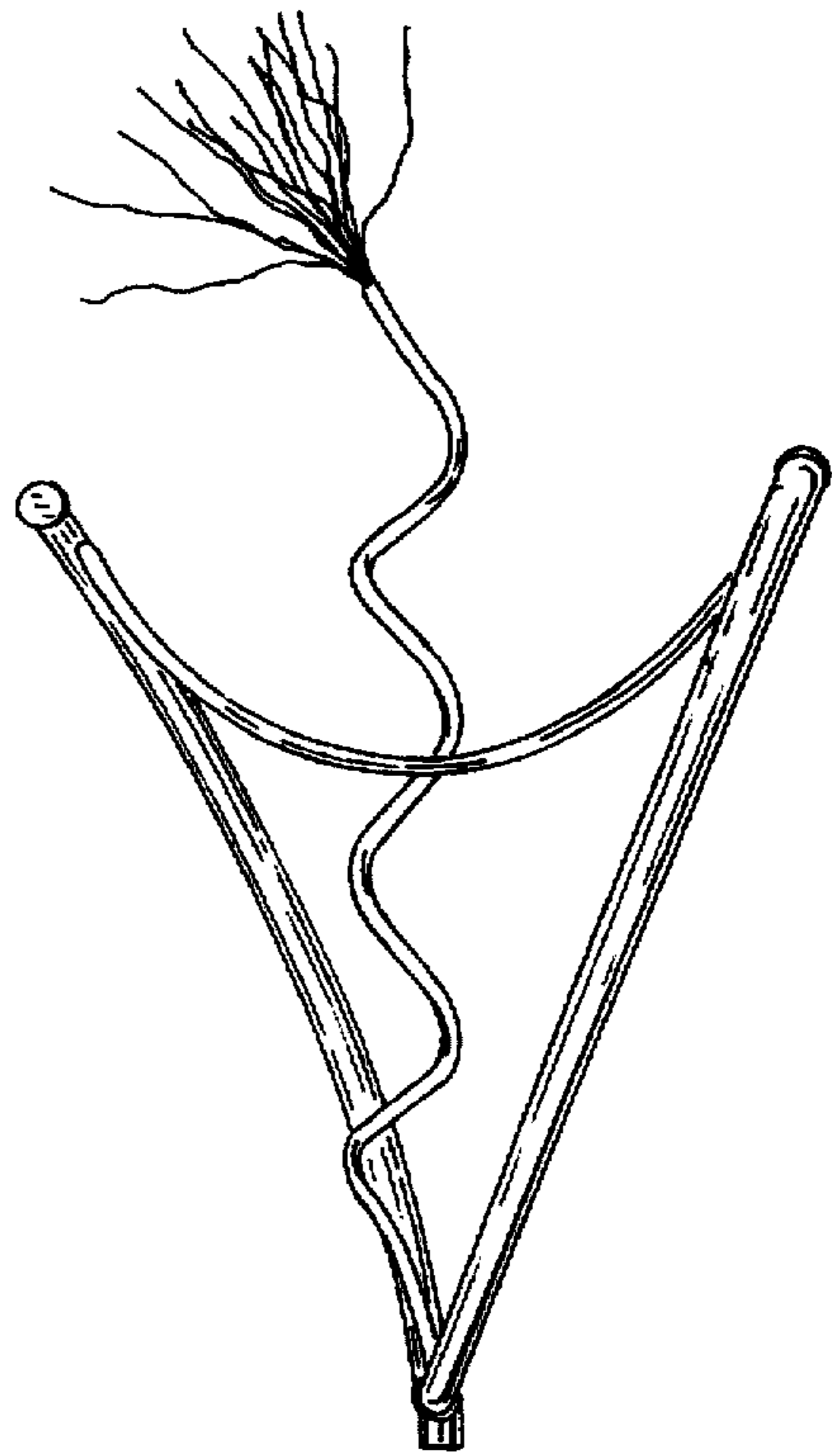

FIG. 5