



US00D390866S

# United States Patent [19] Agata

[11] Patent Number: **Des. 390,866**  
[45] Date of Patent: **\*\*Feb. 17, 1998**

[54] **PHOTOCOPIER**

[75] Inventor: **Nobuyuki Agata, Soka, Japan**

[73] Assignee: **Canon Kabushiki Kaisha, Tokyo, Japan**

[\*\*] Term: **14 Years**

[21] Appl. No.: **66,920**

[22] Filed: **Feb. 24, 1997**

[30] **Foreign Application Priority Data**  
Aug. 26, 1996 [JP] Japan ..... 8-25320

[51] **LOC (6) Cl.** ..... **16-03**

[52] **U.S. Cl.** ..... **D18/37; D18/36**

[58] **Field of Search** ..... **D18/36-39; D14/111, D14/112, 116, 118; 355/50, 97, 128; 399/75, 82, 107, 108, 130, 297, 310, 311**

[56] **References Cited**  
**U.S. PATENT DOCUMENTS**  
D. 354,076 1/1995 Fukuda et al. .... D18/36

D. 354,510 1/1995 Ishibashi et al. .... D18/36  
D. 357,933 5/1995 Ishibashi et al. .... D18/36  
D. 366,895 2/1996 Takahashi ..... D18/36  
D. 369,379 4/1996 Takahashi ..... D18/36  
D. 371,573 7/1996 Takahashi ..... D18/36

*Primary Examiner*—Caron D. Veynar  
*Attorney, Agent, or Firm*—Fitzpatrick, Cella, Harper & Scinto

### [57] CLAIM

The ornamental design for a photocopier, as shown and described.

### DESCRIPTION

FIG. 1 is a front view of a photocopier showing my new design;  
FIG. 2 is a rear view thereof;  
FIG. 3 is a top plan view thereof;  
FIG. 4 is a bottom plan view thereof;  
FIG. 5 is a left side view thereof;  
FIG. 6 is a right side view thereof; and,  
FIG. 7 is a perspective view thereof.

**1 Claim, 4 Drawing Sheets**

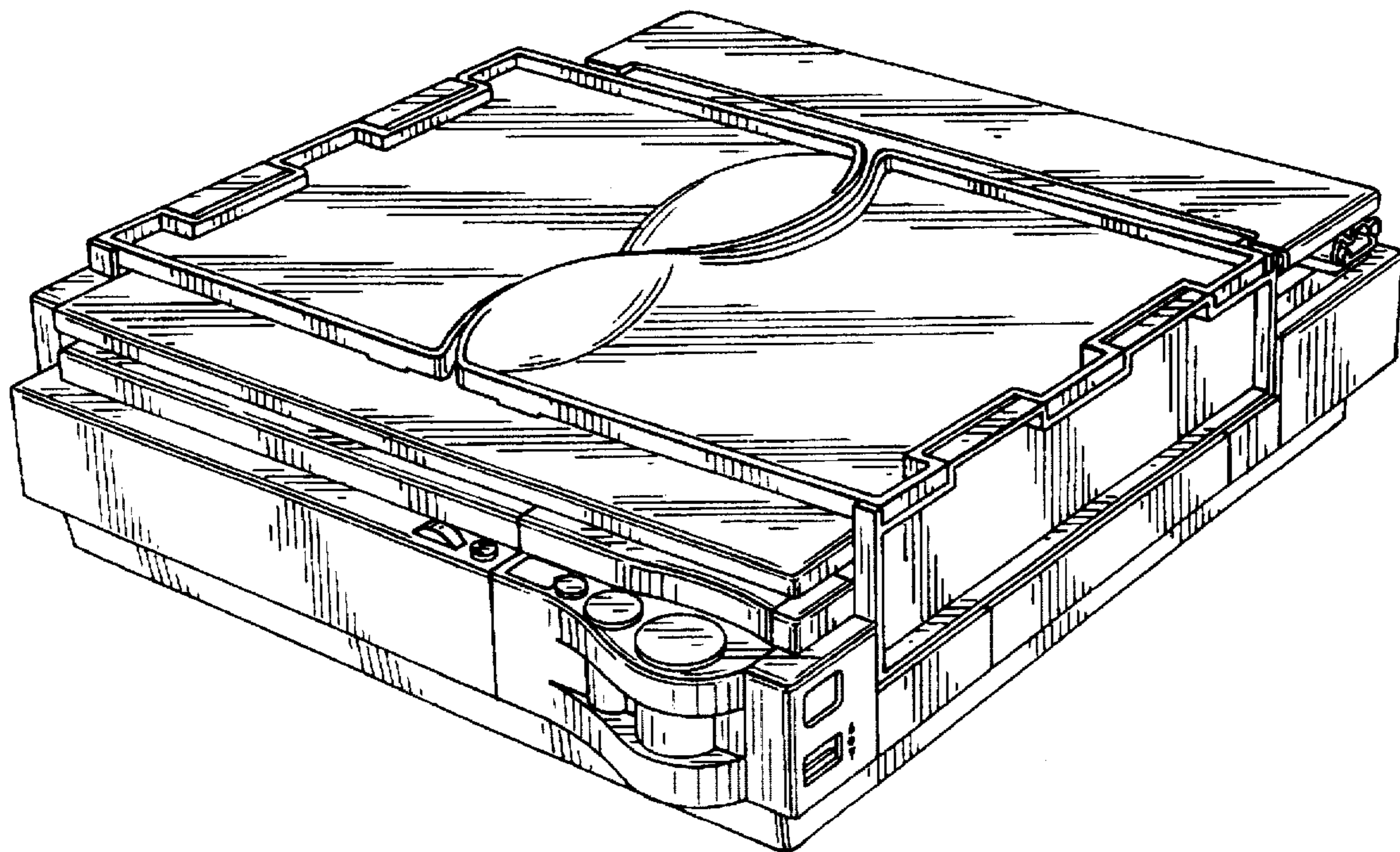

*FIG. 1*

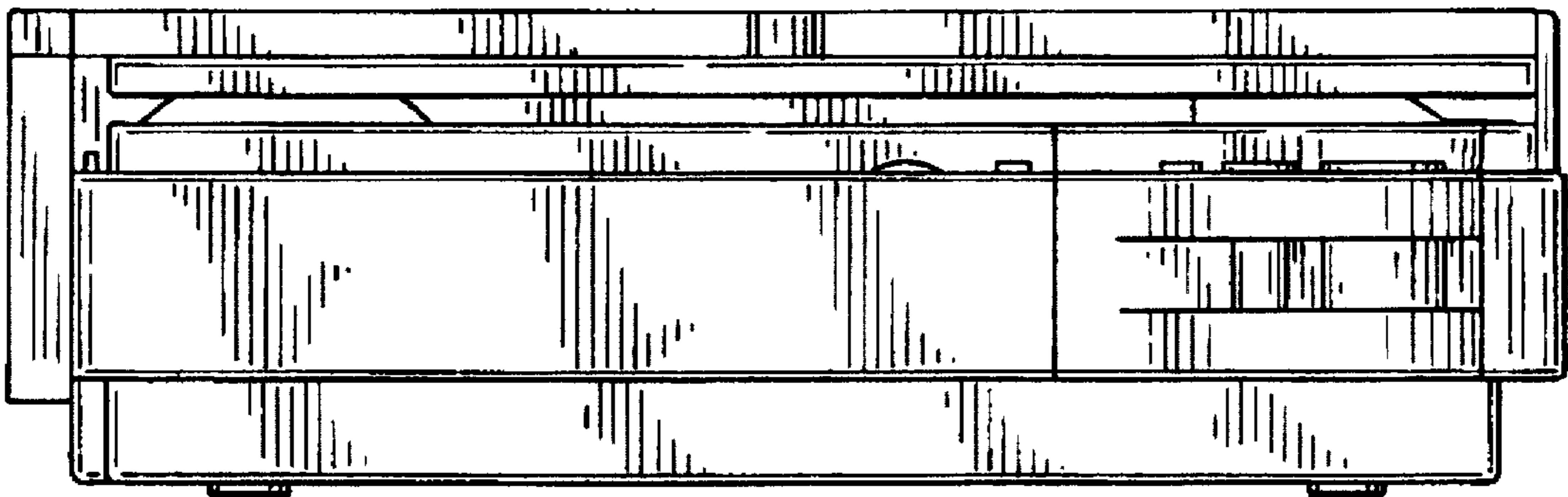

*FIG. 2*

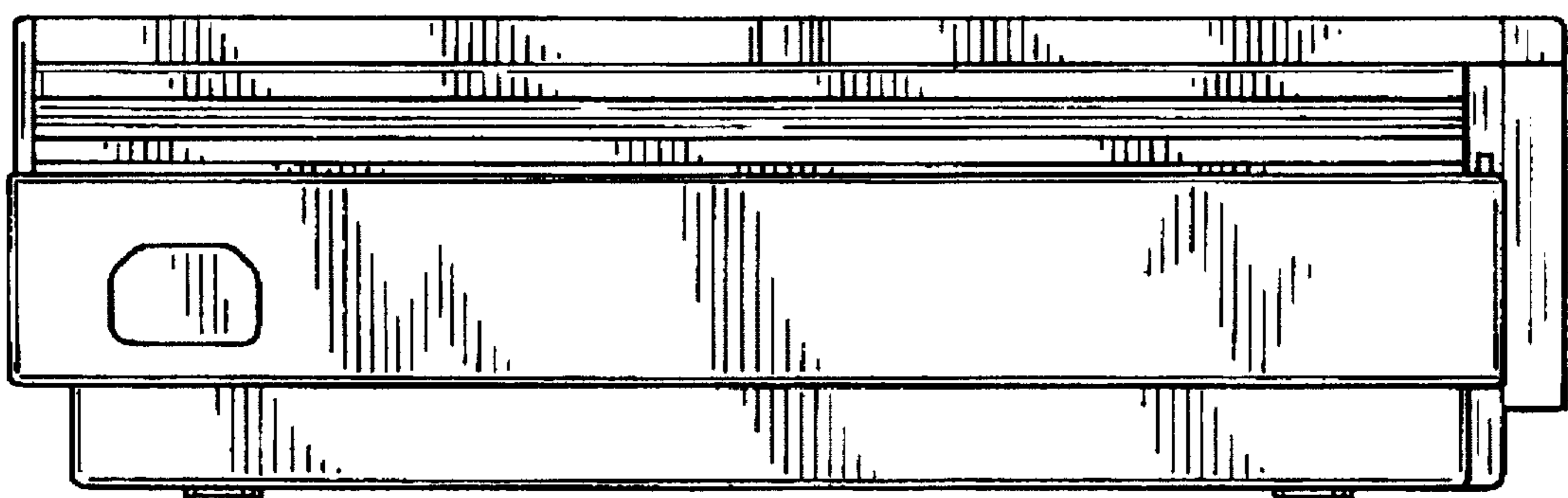

*FIG. 3*

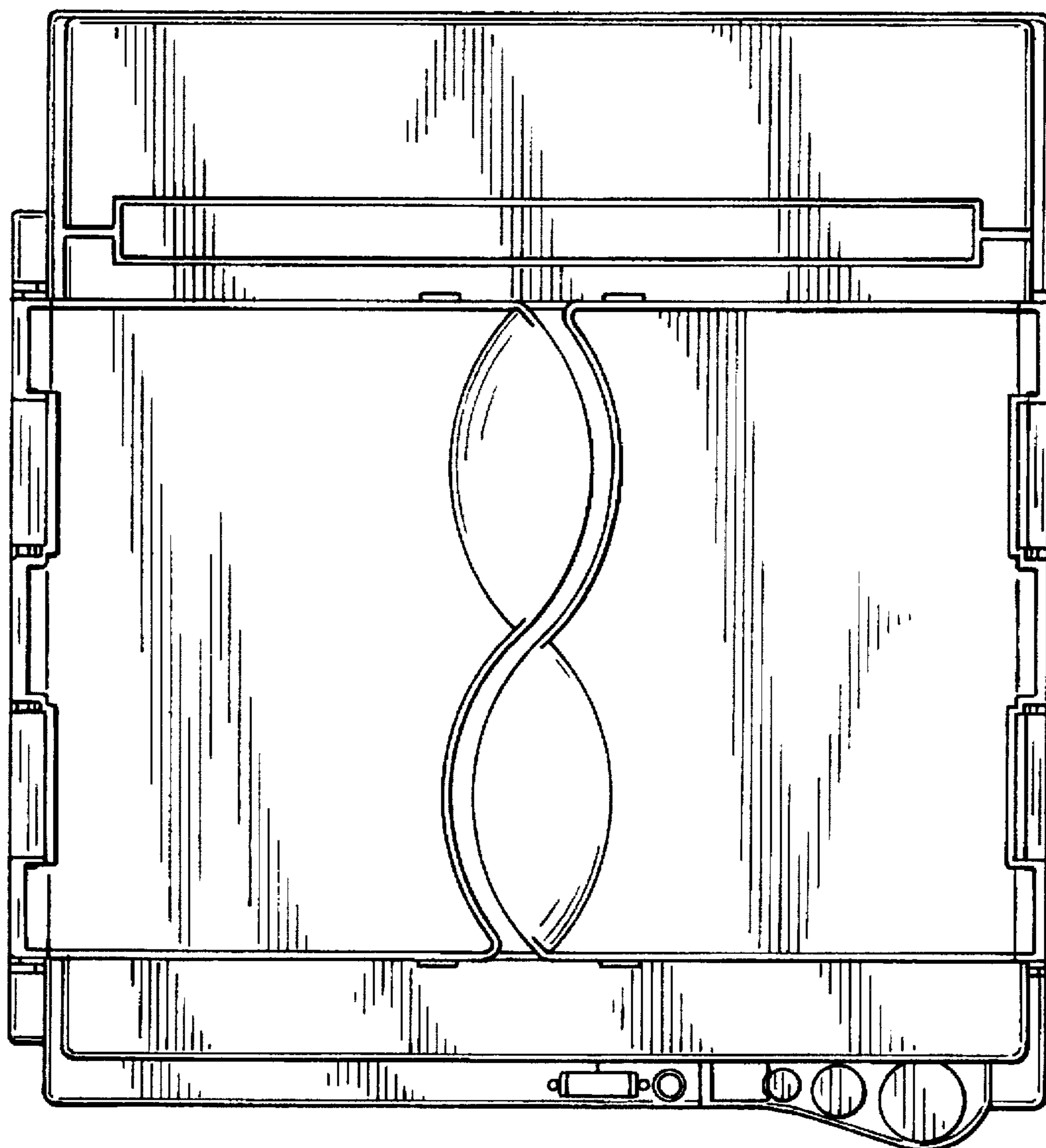

FIG. 4

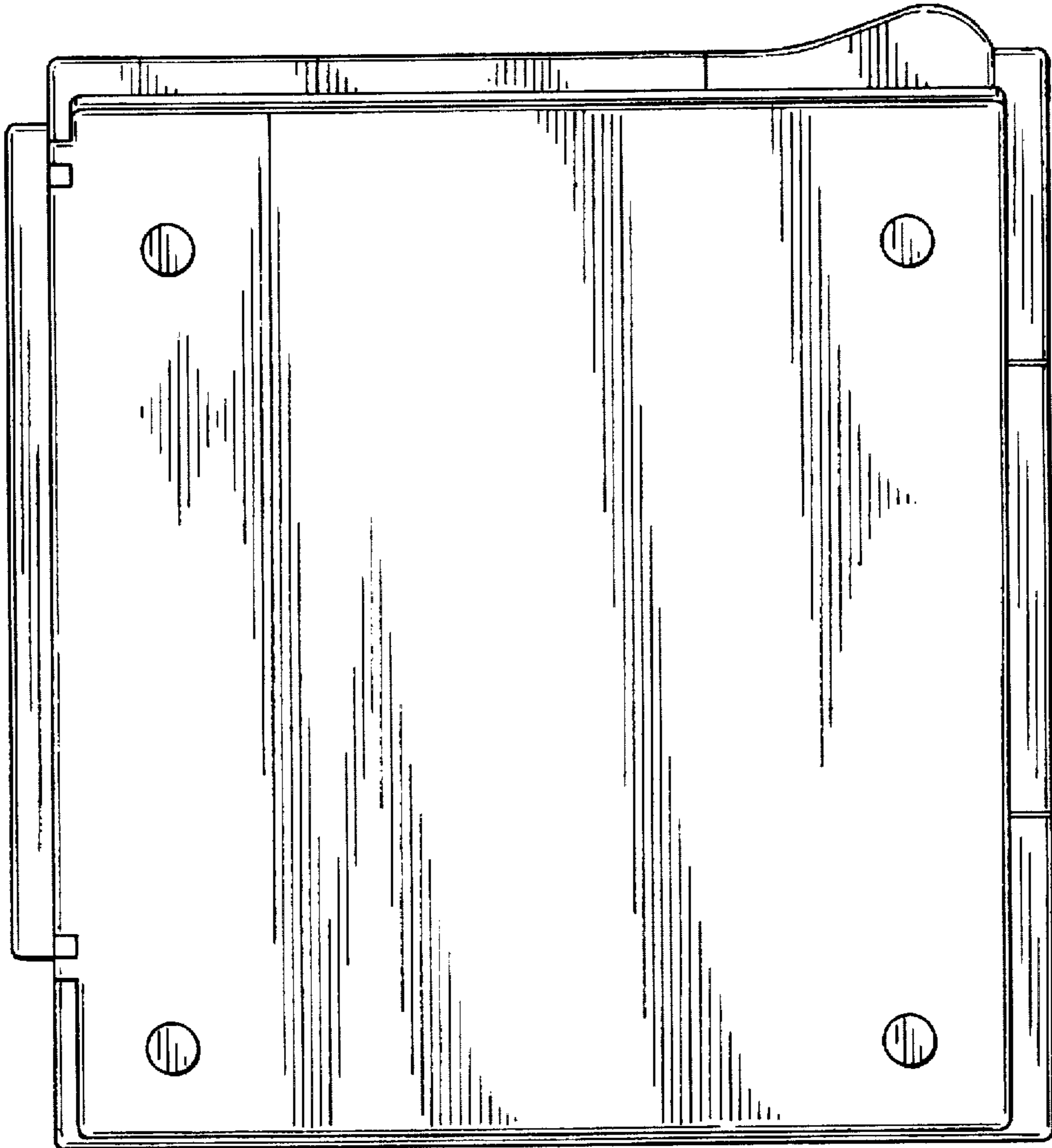

FIG. 5

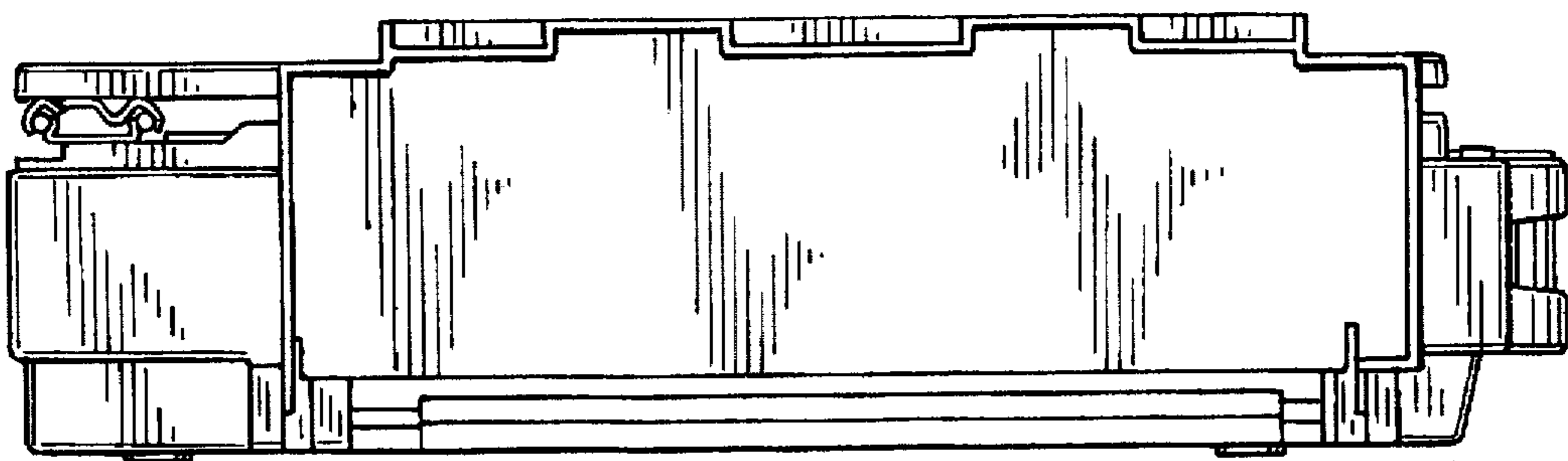



FIG. 6

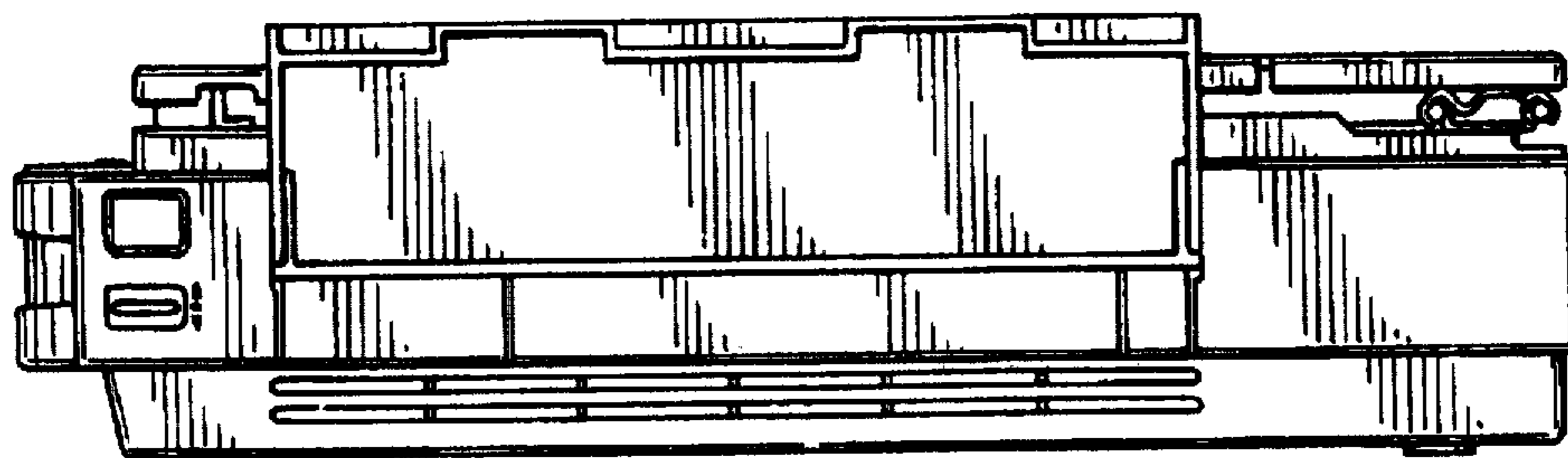

FIG. 7

