



US00D390734S

United States Patent [19]
Bailey

[11] **Patent Number:** **Des. 390,734**
[45] **Date of Patent:** ****Feb. 17, 1998**

[54] **CONTAINER FOR FOIL AND PLASTIC WRAP WITH SELF-LOCKING LID AND OR BRACKET FOR HANGING**

D. 351,303 10/1994 Crawford et al. D6/518
2,304,312 12/1942 Meglitz D6/518 X

Primary Examiner—Brian N. Vinson

[76] **Inventor:** **Janet Elizabeth Bailey**, 2066 Katrina Way, Upland, Calif. 91784

[57] **CLAIM**

[**] **Term:** **14 Years**

The ornamental design for a container for foil and plastic wrap with self-locking lid and/or bracket for hanging, as shown and described.

[21] **Appl. No.:** **61,034**

DESCRIPTION

[22] **Filed:** **Oct. 15, 1996**

FIG. 1 is a front elevational view of the container for foil and plastic wrap with self-locking lid and/or bracket for hanging showing my new design;

[51] **LOC (6) Cl.** **08-08**

[52] **U.S. Cl.** **D6/518**

[58] **Field of Search** D6/518-523; 206/389, 206/391; 242/550, 570, 590, 595, 596, 600, 601; 312/34.8

FIG. 2 is a rear elevational view thereof;

FIG. 3 is a left view thereof;

FIG. 4 is a right view thereof;

FIG. 5 is a top plan view thereof;

FIG. 6 is a bottom plan view thereof; and,

FIG. 7 is an isometric view thereof with container lid in the open position.

[56] **References Cited**

U.S. PATENT DOCUMENTS

D. 212,552 10/1968 Shapira D6/518
D. 257,154 9/1980 Stark et al. D6/522 X

1 Claim, 3 Drawing Sheets

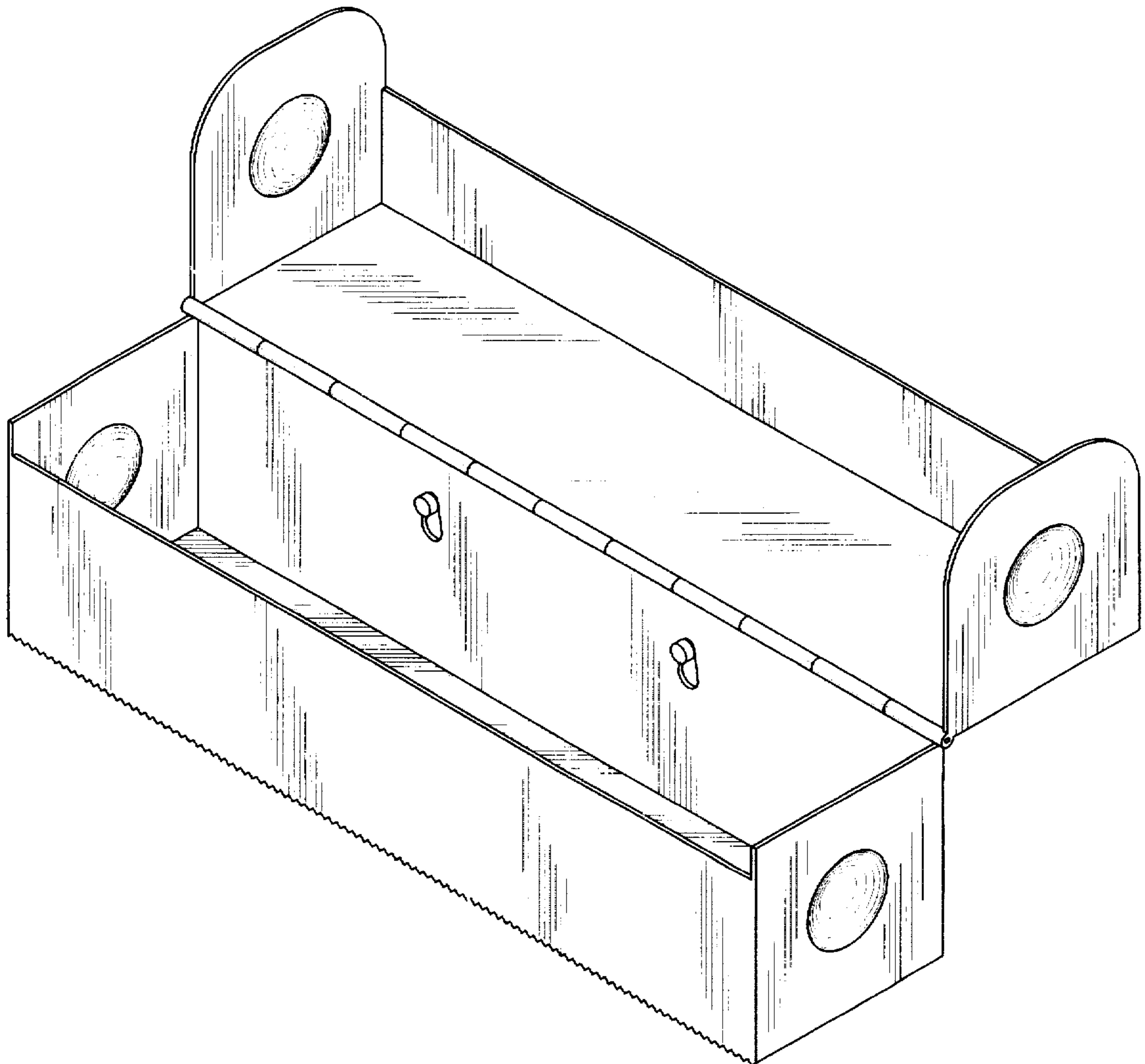

FIG. 1

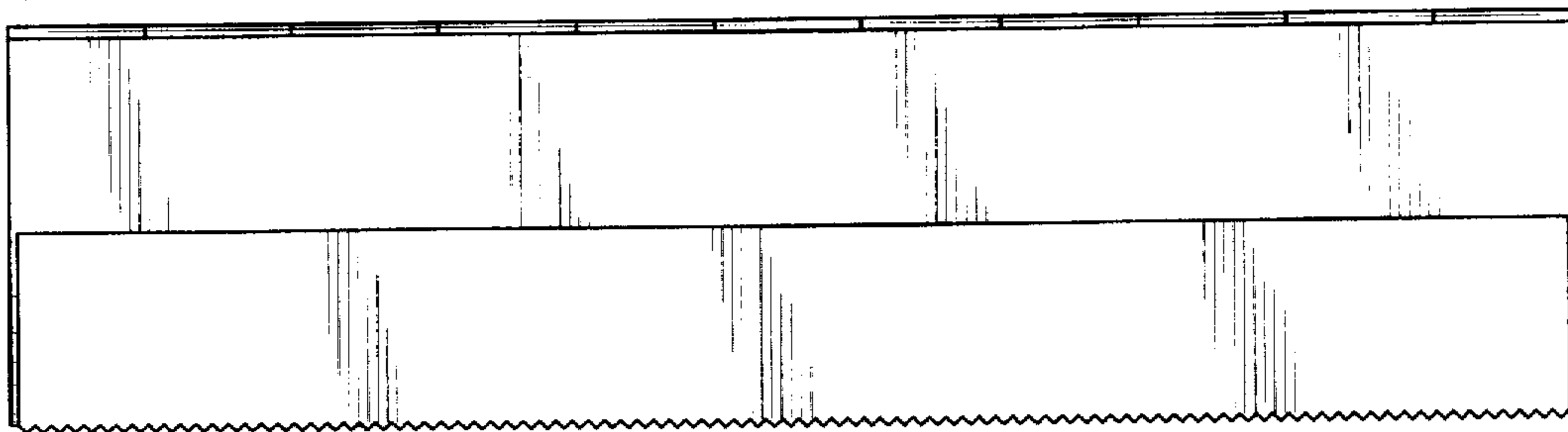

FIG. 2

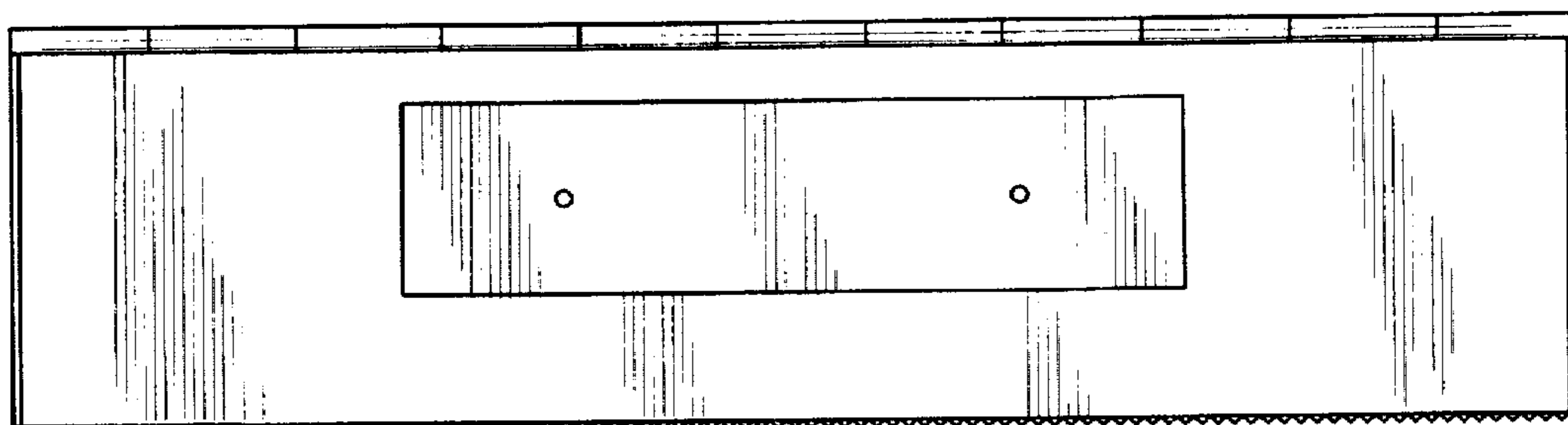

FIG. 3

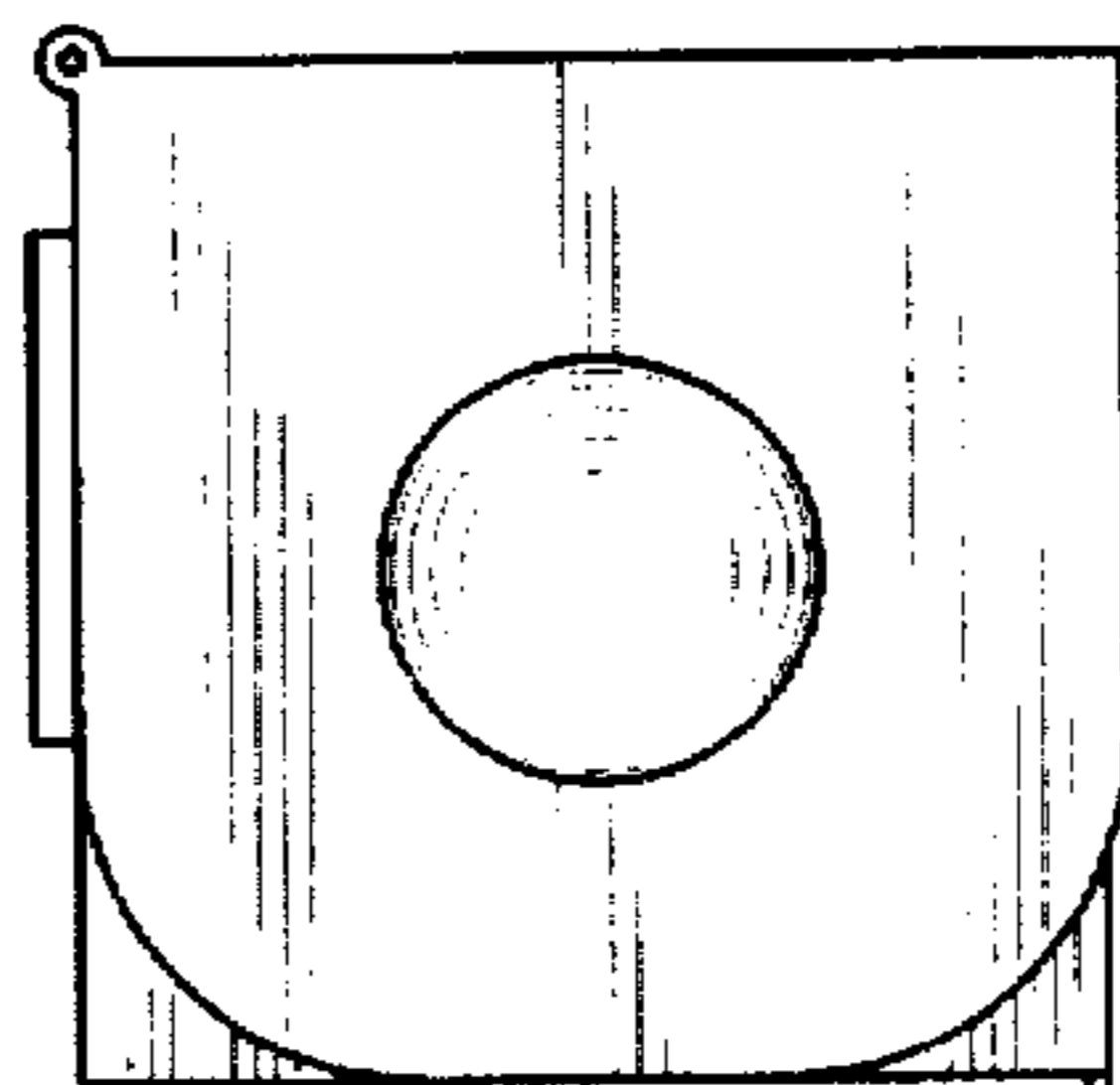

FIG. 4

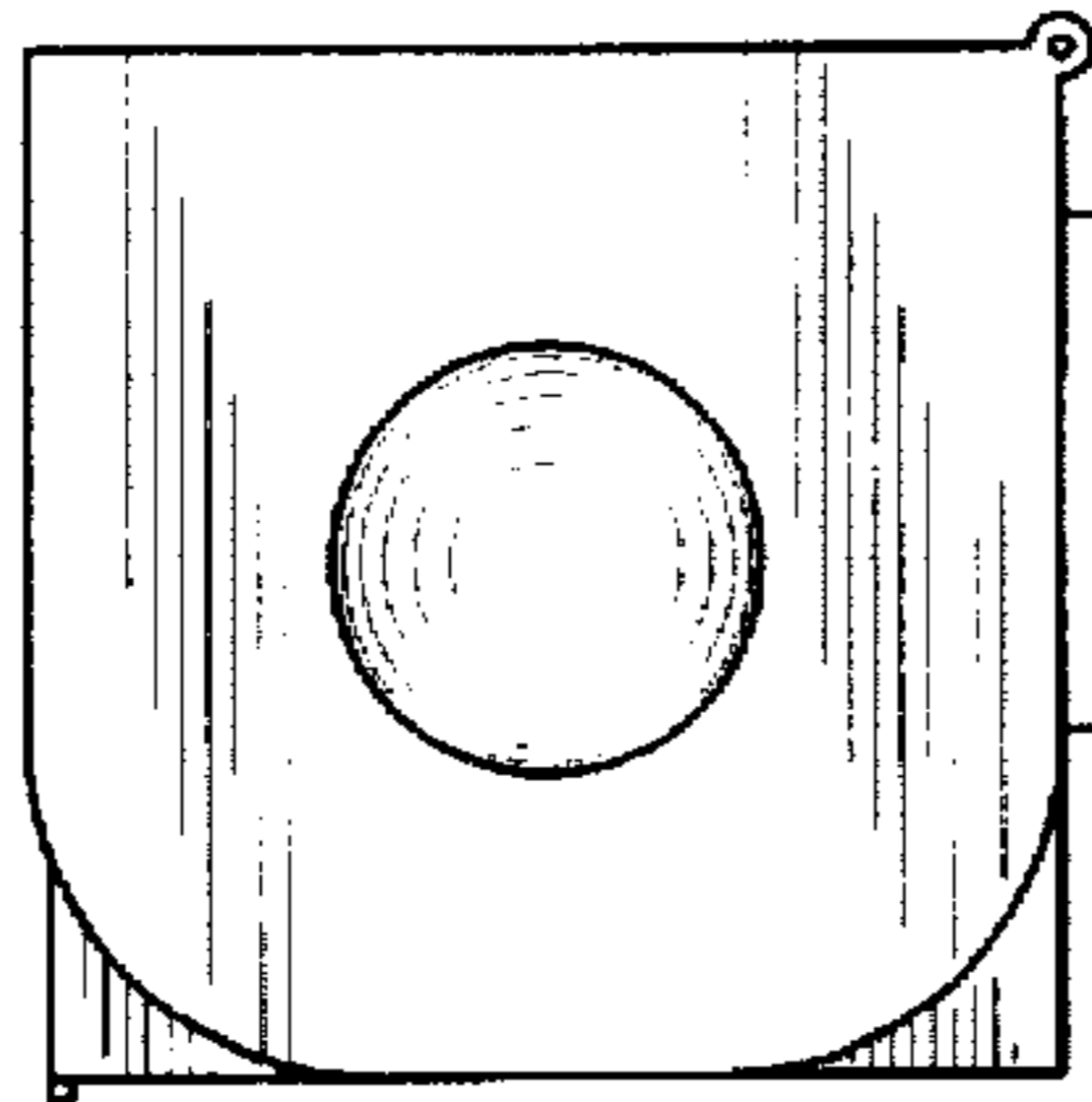

FIG. 5

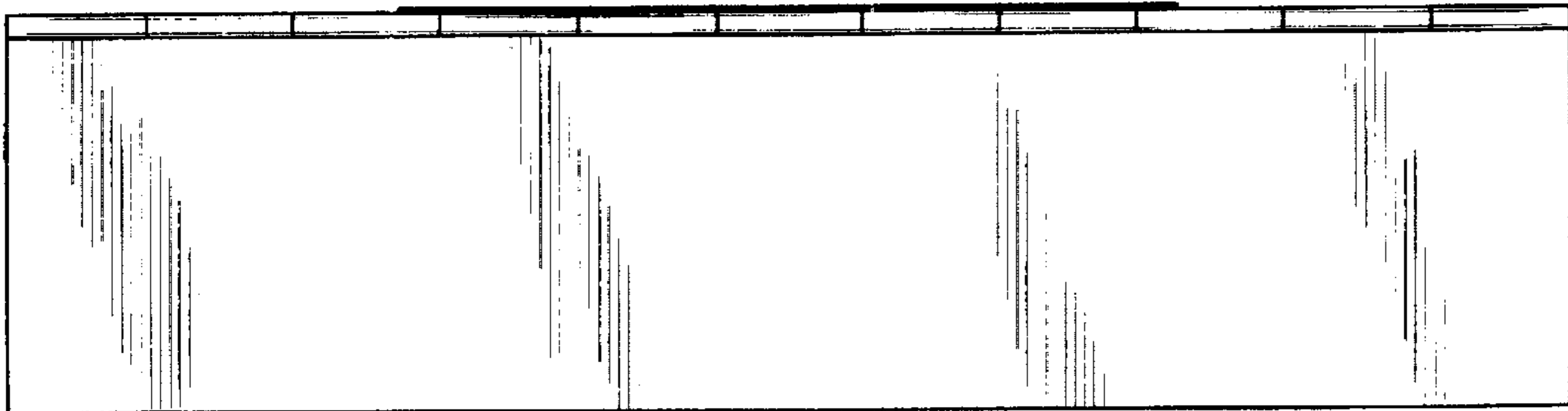

FIG. 6

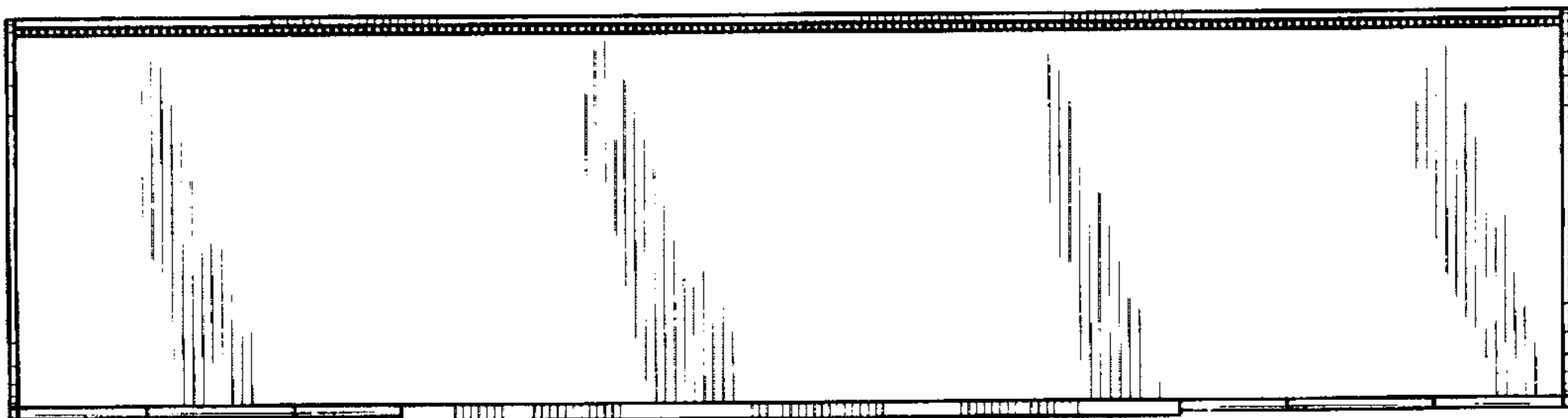

FIG. 7

