



US00D390715S

United States Patent [19]

[11] Patent Number: **Des. 390,715**

Natuzzi et al.

[45] Date of Patent: ****Feb. 17, 1998**

[54] SEAT

[75] Inventors: **Pasquale Natuzzi, Santeramo In Colle; Arcangelo Scarati, Talsano, both of Italy**

[73] Assignee: **Industrie Natuzzi, Spa, Bari, Italy**

[**] Term: **14 Years**

[21] Appl. No.: **63,975**

[22] Filed: **Dec. 20, 1996**

[51] LOC (6) Cl. **06-01**

[52] U.S. Cl. **D6/381; D6/334**

[58] Field of Search **D6/334, 335, 364, D6/371, 373, 381, 500, 501, 502; 297/232**

[56] **References Cited**

U.S. PATENT DOCUMENTS

D. 362,562	9/1995	Natuzzi et al.	D6/381
D. 363,614	10/1995	Natuzzi et al.	D6/381
D. 369,479	5/1996	Natuzzi et al.	D6/381
D. 373,484	9/1996	Natuzzi et al.	D6/381
D. 373,485	9/1996	Natuzzi et al.	D6/381
D. 374,356	10/1996	Natuzzi et al.	D6/381

OTHER PUBLICATIONS

Natuzzi Model 848, photocopy and schematics, International Home Furnishings Market, High Point, NC, Apr. 1991.

Natuzzi Model 879, photocopy and schematics, International Home Furnishings Market. High Point, NC, Apr. 1991.

Natuzzi Model IPNO, Apr., 1986, at International Home Furnishings Market in High Point, North Carolina.

Natuzzi Model 416, Oct., 1987, at International Home Furnishings Market in High Point, North Carolina.

Natuzzi Model 497, Apr., 1989, at International Home Furnishings Market in High Point, North Carolina.

Natuzzi Model 604/605, Oct., 1987, at International Home Furnishings Market in High Point, North Carolina.

Natuzzi Model 769, Oct., 1990, at International Home Furnishings Market in High Point, North Carolina.

Natuzzi Model 894, Apr., 1992, at International Home Furnishings Market in High Point, North Carolina.

Natuzzi Model 1036, Apr., 1993, at International Home Furnishings Market in High Point, North Carolina.

Natuzzi Model 1221, Oct., 1994, at International Home Furnishings Market in High Point, North Carolina.

Natuzzi Model 1029, Apr., 1993, at International Home Furnishings Market in High Point, North Carolina.

Natuzzi Model 1073, Apr., 1993, at International Home Furnishings Market in High Point, North Carolina.

Natuzzi Model 1075, Oct., 1993, at International Home Furnishings Market in High Point, North Carolina.

Primary Examiner—Gary D. Watson

Attorney, Agent, or Firm—Bell Seltzer Intellectual Property Law Group Alston & Bird, LLP

[57] **CLAIM**

The ornamental design for a seat, as shown and described.

DESCRIPTION

FIG. 1 is a front perspective view of a seat showing our new design in the form of a sofa;

FIG. 2 is a front elevational view thereof;

FIG. 3 is a top plan view thereof;

FIG. 4 is a right side elevational view, the left side being a mirror image thereof;

FIG. 5 is a rear perspective view thereof;

FIG. 6 is a front elevational view of a seat showing our new design in the form of a loveseat; and,

FIG. 7 is front elevational view of a seat showing our new design in the form of a chair.

The broken lines shown herein are for illustrative purposes only and form no part of the claimed design.

The rear views of FIGS. 6 and 7 are like FIG. 5, the difference being a matter of length.

The end views of FIGS. 6 and 7 are like FIG. 4.

FIGS. 1 and 5 have been shown on an enlarged scale with respect to the other views.

1 Claim, 3 Drawing Sheets

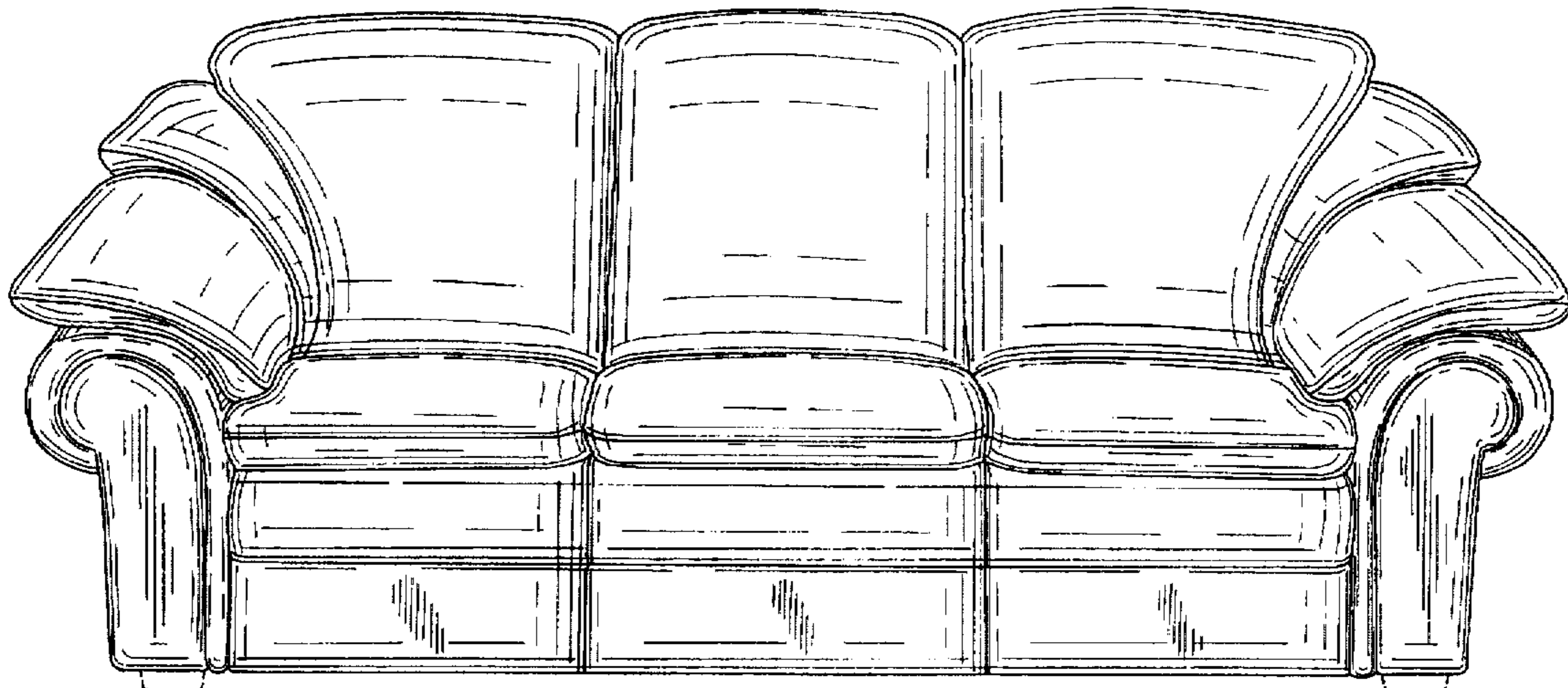

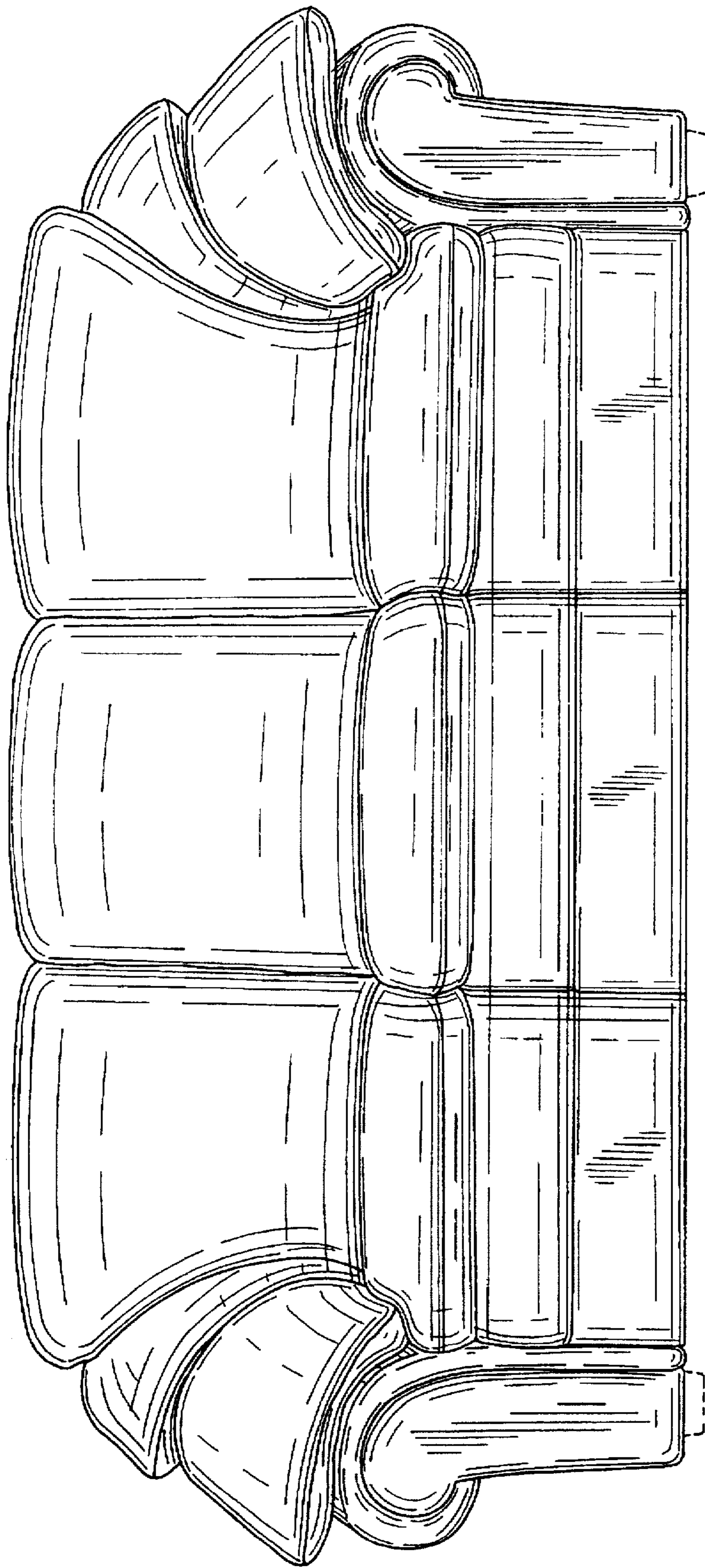

FIG. 1.

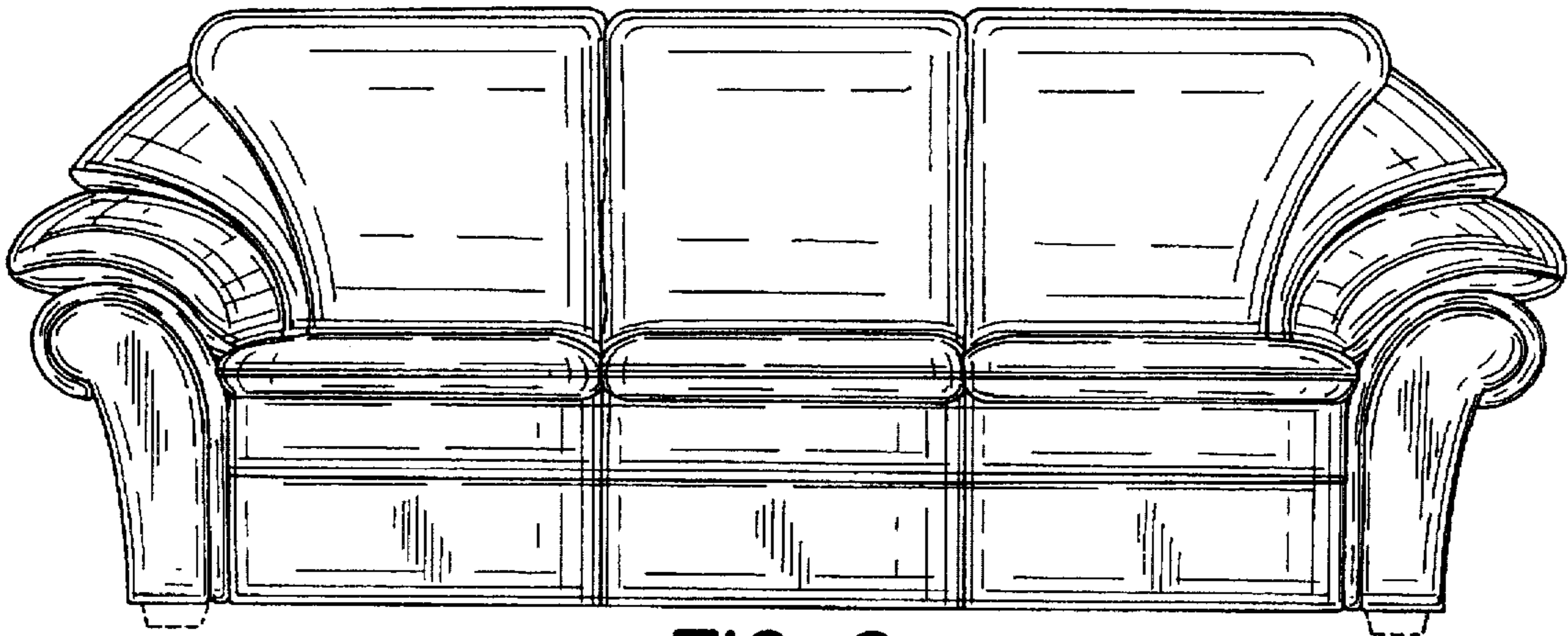

FIG. 2.



FIG. 3.

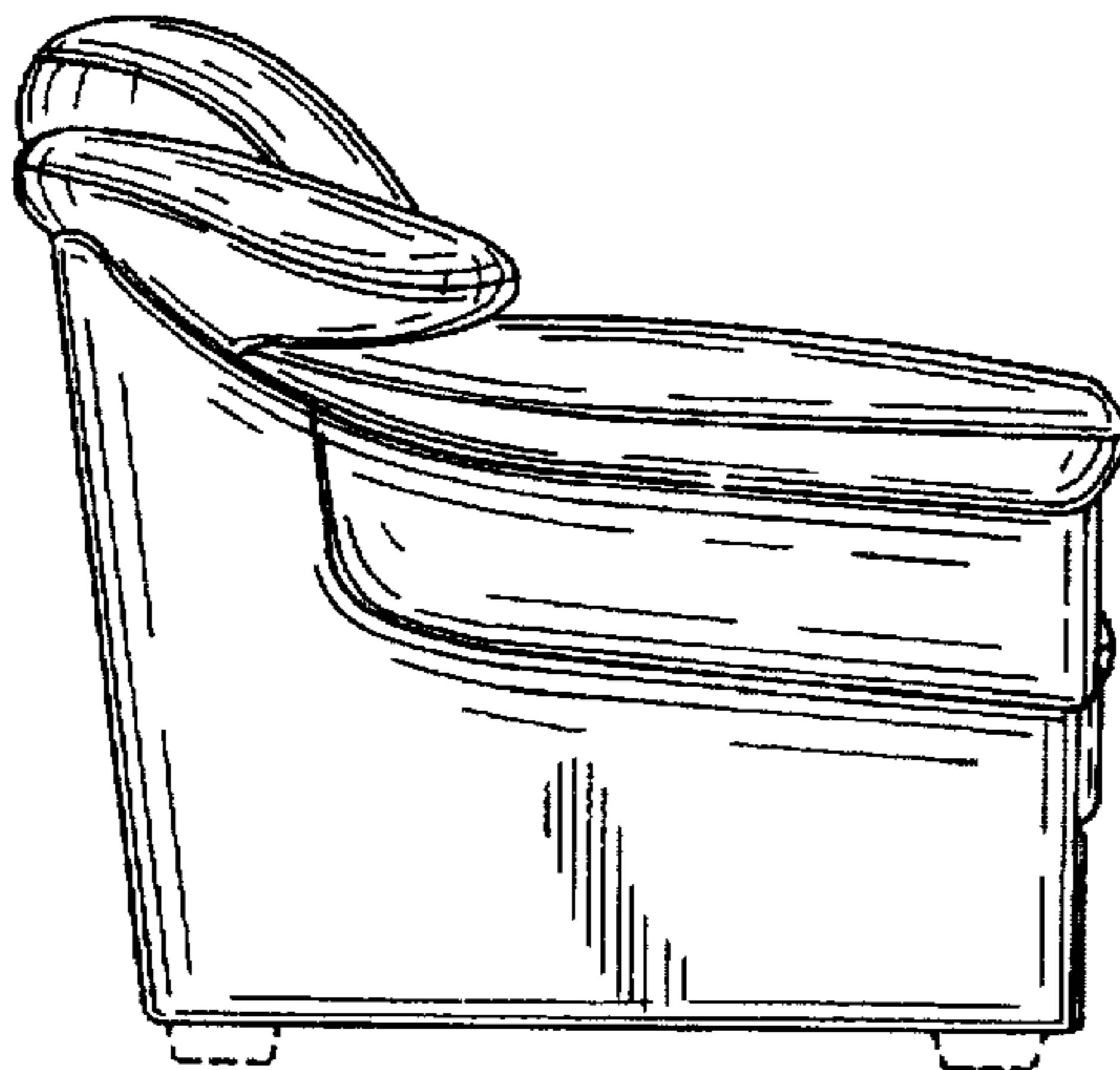

FIG. 4.

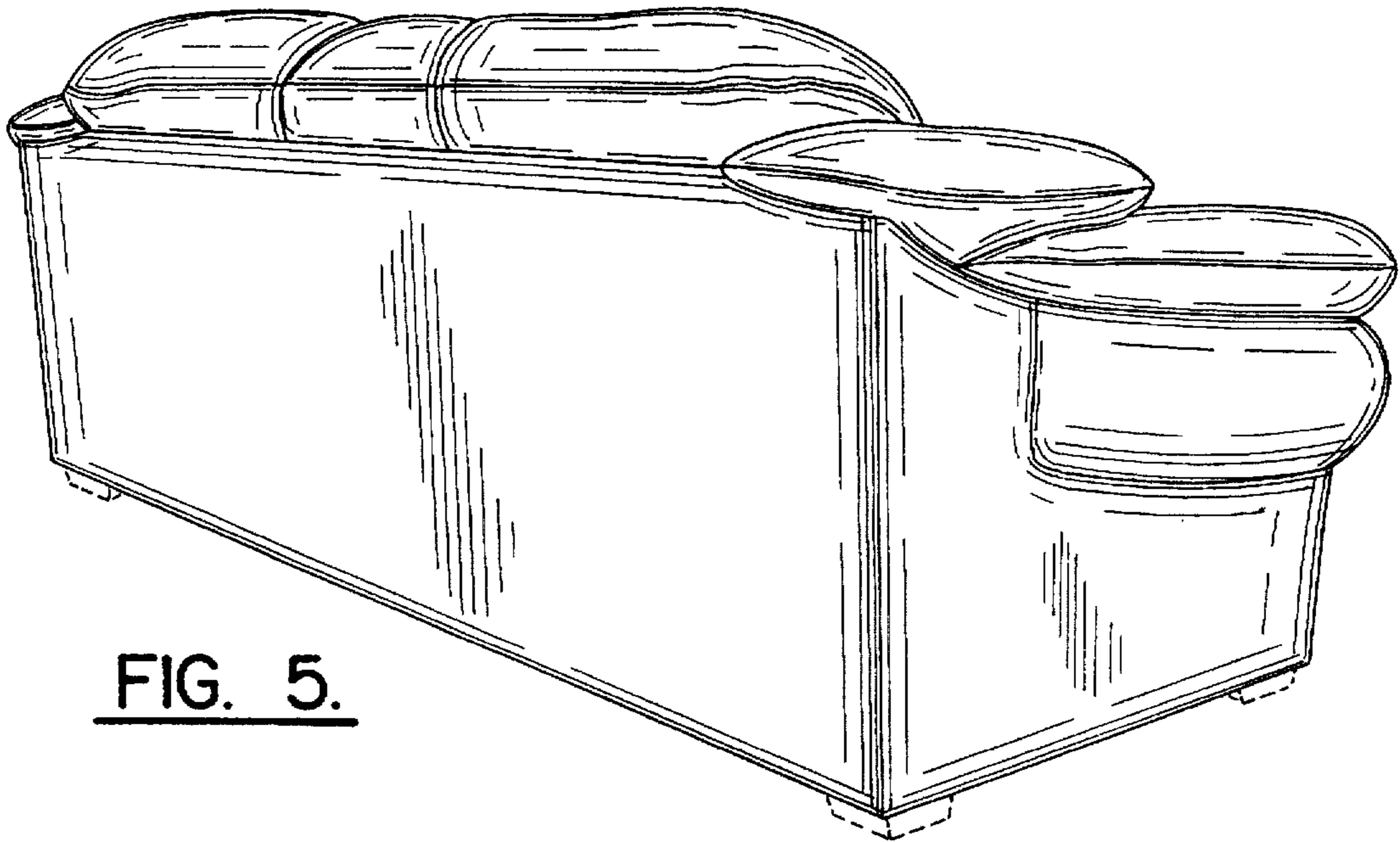

FIG. 5.

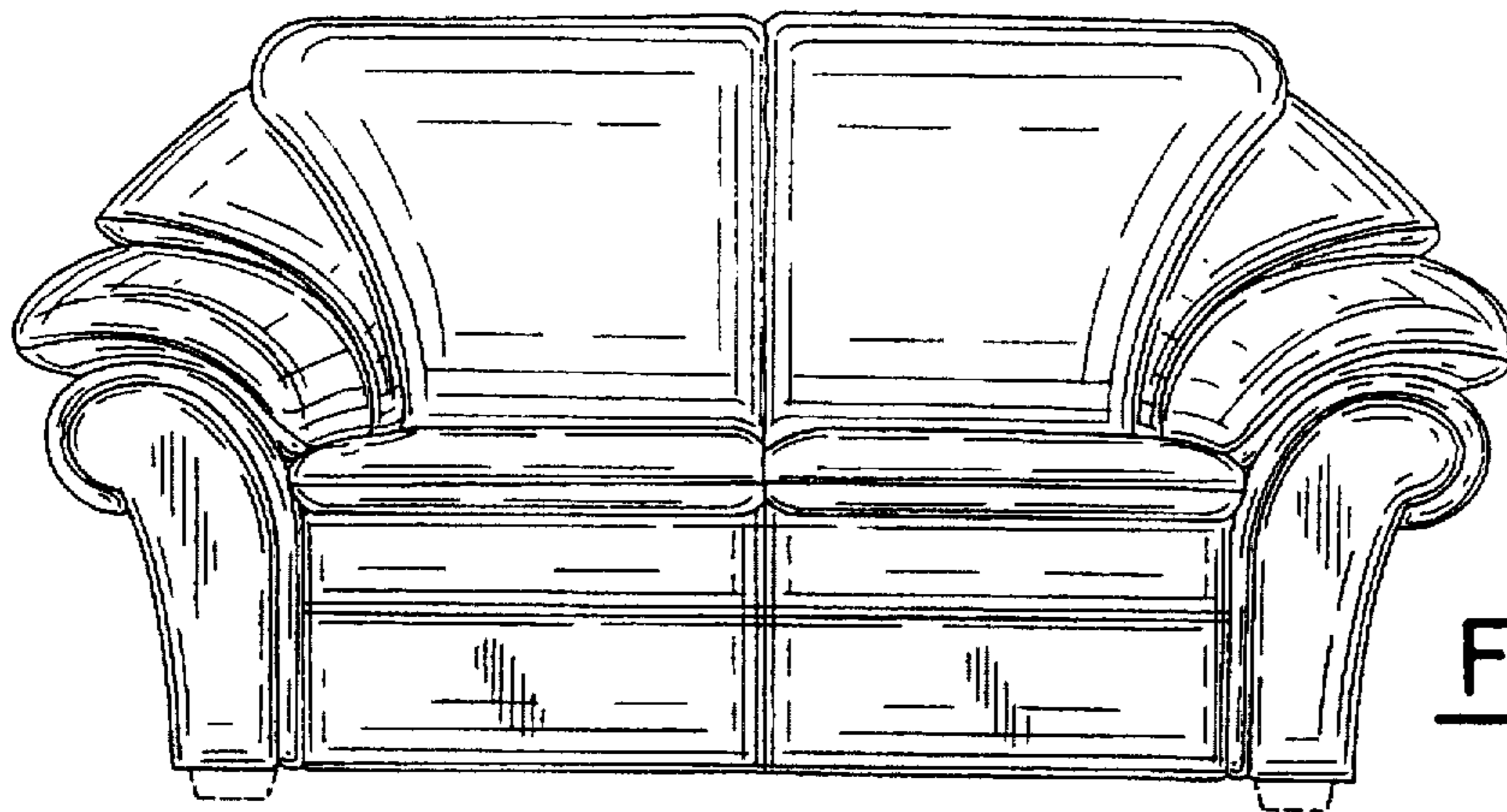

FIG. 6.

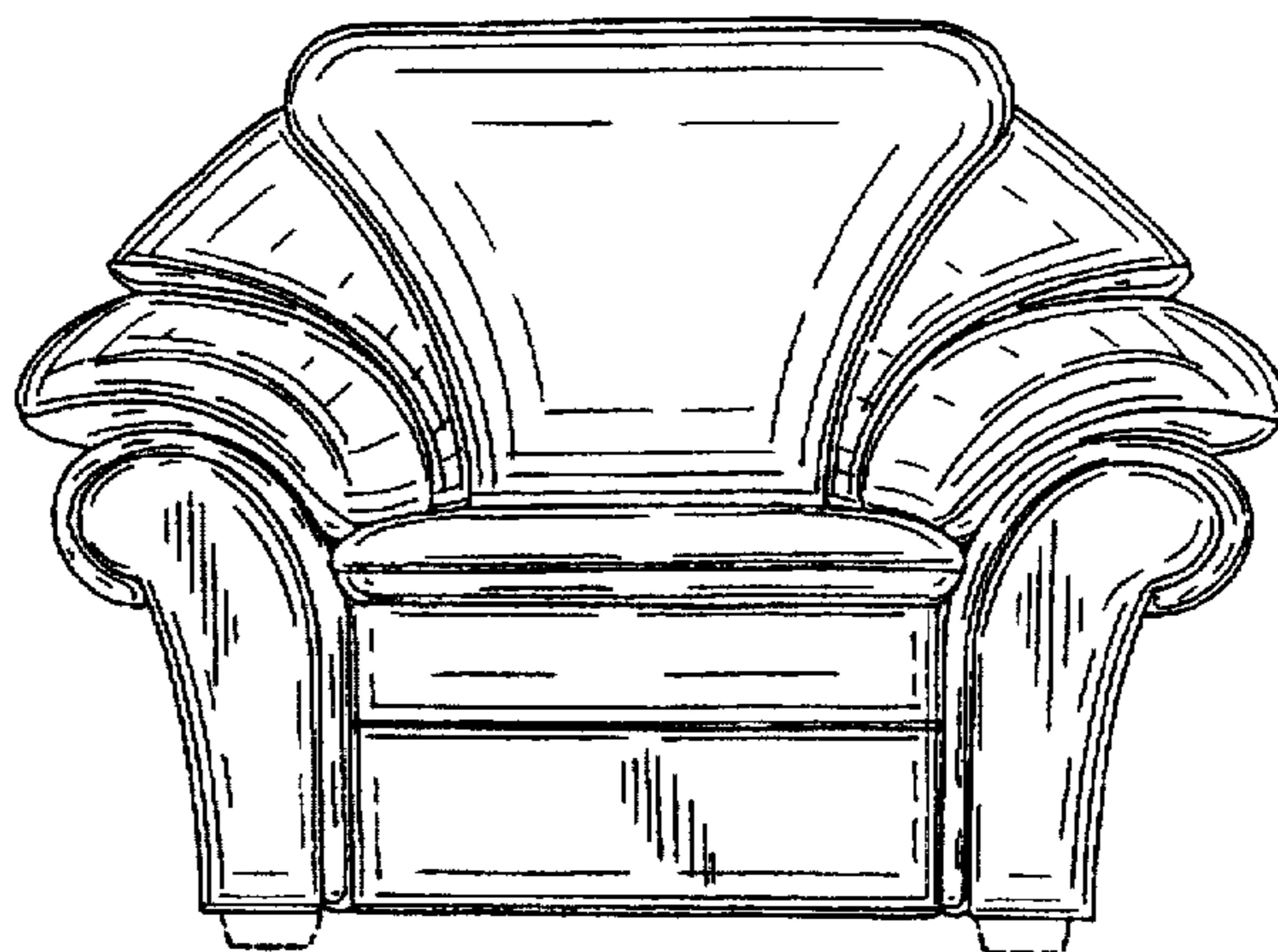

FIG. 7.