



US00D390653S

United States Patent [19]

Blasdell et al.

[11] Patent Number: **Des. 390,653**

[45] Date of Patent: ****Feb. 10, 1998**

[54] **INHALER**

[76] Inventors: **Richard J. Blasdell**, 13231 N. 14th Pl., Phoenix, Ariz. 85022; **Raymond L. Blasdell**, 691 E. Fairway Dr., Litchfield Park, Ariz. 85340

[**] Term: **14 Years**

[21] Appl. No.: **67,091**

[22] Filed: **Mar. 4, 1997**

[51] LOC (6) Cl. **29-02**

[52] U.S. Cl. **D24/110.5**

[58] Field of Search D24/110, 110.1-110.6;
128/201.28, 202.13, 203.29, 205.24, 205.25,
206.12, 206.24, 200.24, 206.13, 206.15,
206.21, 206.28, 207.11-207.12, 207.18,
203.12, 204.18

[56] **References Cited**

U.S. PATENT DOCUMENTS

D. 321,570 11/1991 Blasdell et al. .

D. 362,303	9/1995	Kurokawa	D24/110.6
3,643,686	2/1972	Koegel	128/207.12
5,018,519	5/1991	Brown	128/206.21
5,109,839	5/1992	Blasdell et al. .	
5,311,862	5/1994	Blasdell et al. .	

Primary Examiner—Ruth McInroy
Attorney, Agent, or Firm—Parsons & Goltry; Robert A. Parsons; Michael W. Goltry

[57] CLAIM

The ornamental design for an inhaler, as shown and described.

DESCRIPTION

FIG. 1 is a perspective view of an inhaler, showing our new design;
FIG. 2 is a front elevational view thereof;
FIG. 3 is a top plan view thereof;
FIG. 4 is a right side elevational view thereof;
FIG. 5 is a rear elevational view thereof;
FIG. 6 is a left side elevational view thereof; and,
FIG. 7 is a bottom plan view thereof.

1 Claim, 1 Drawing Sheet

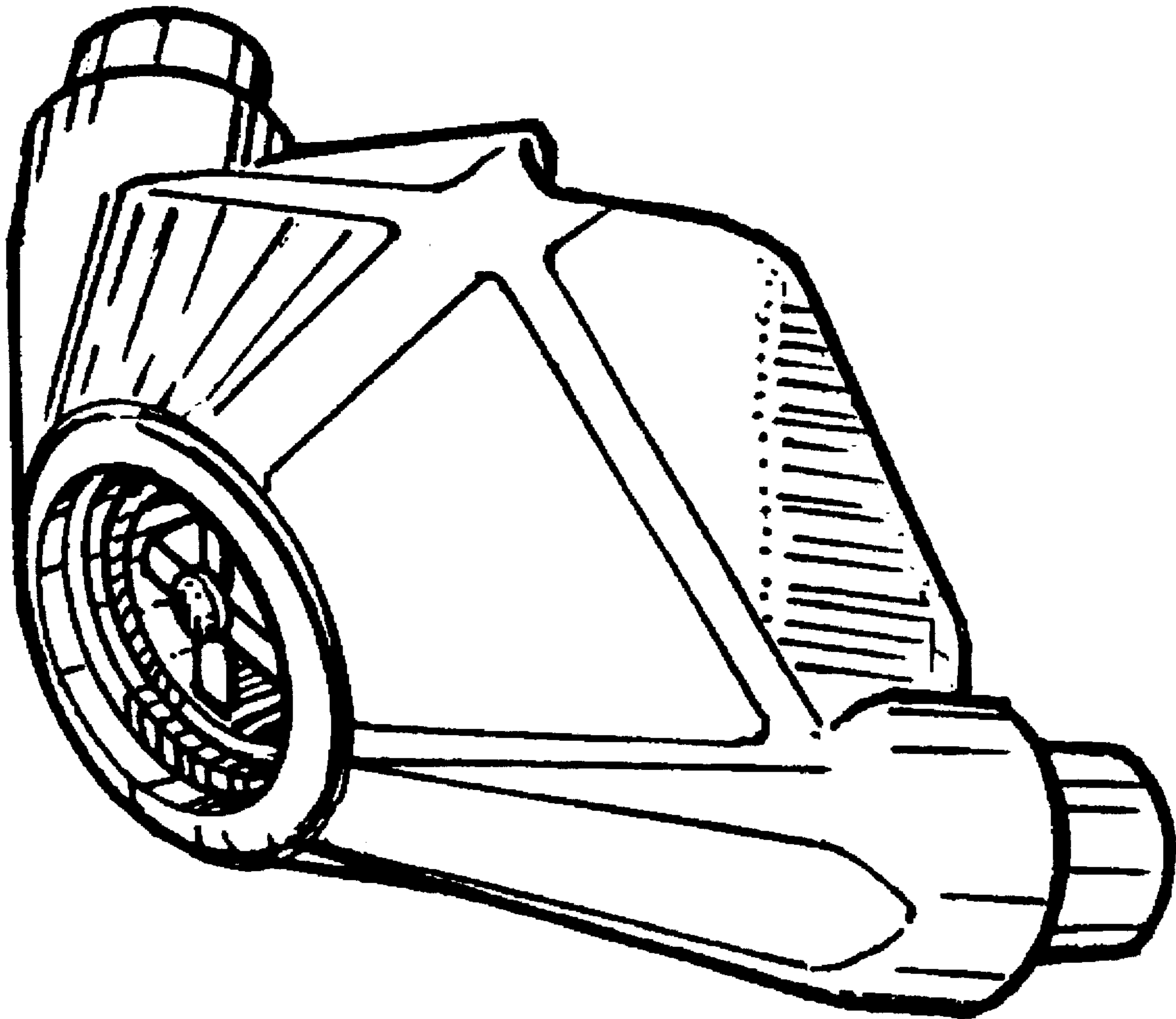

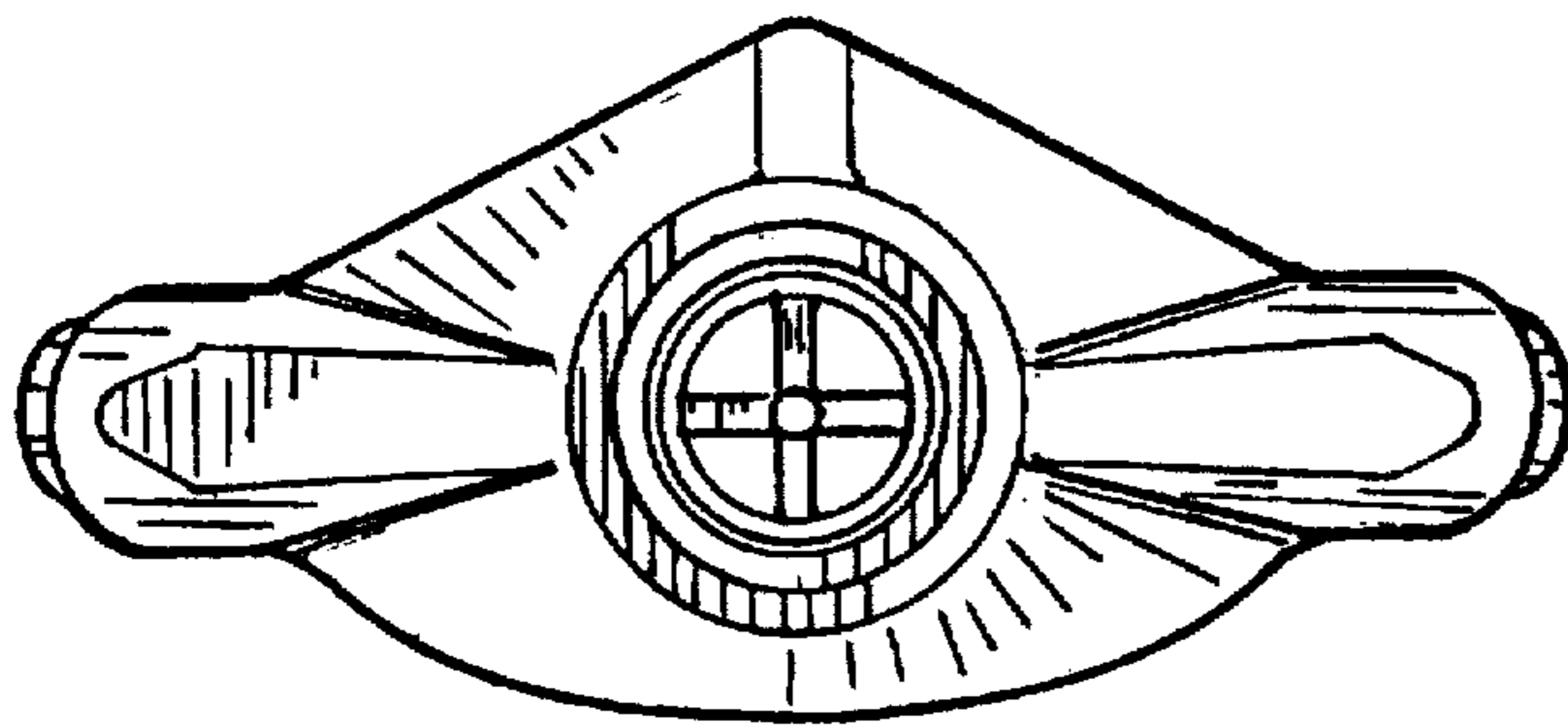

FIG. 2

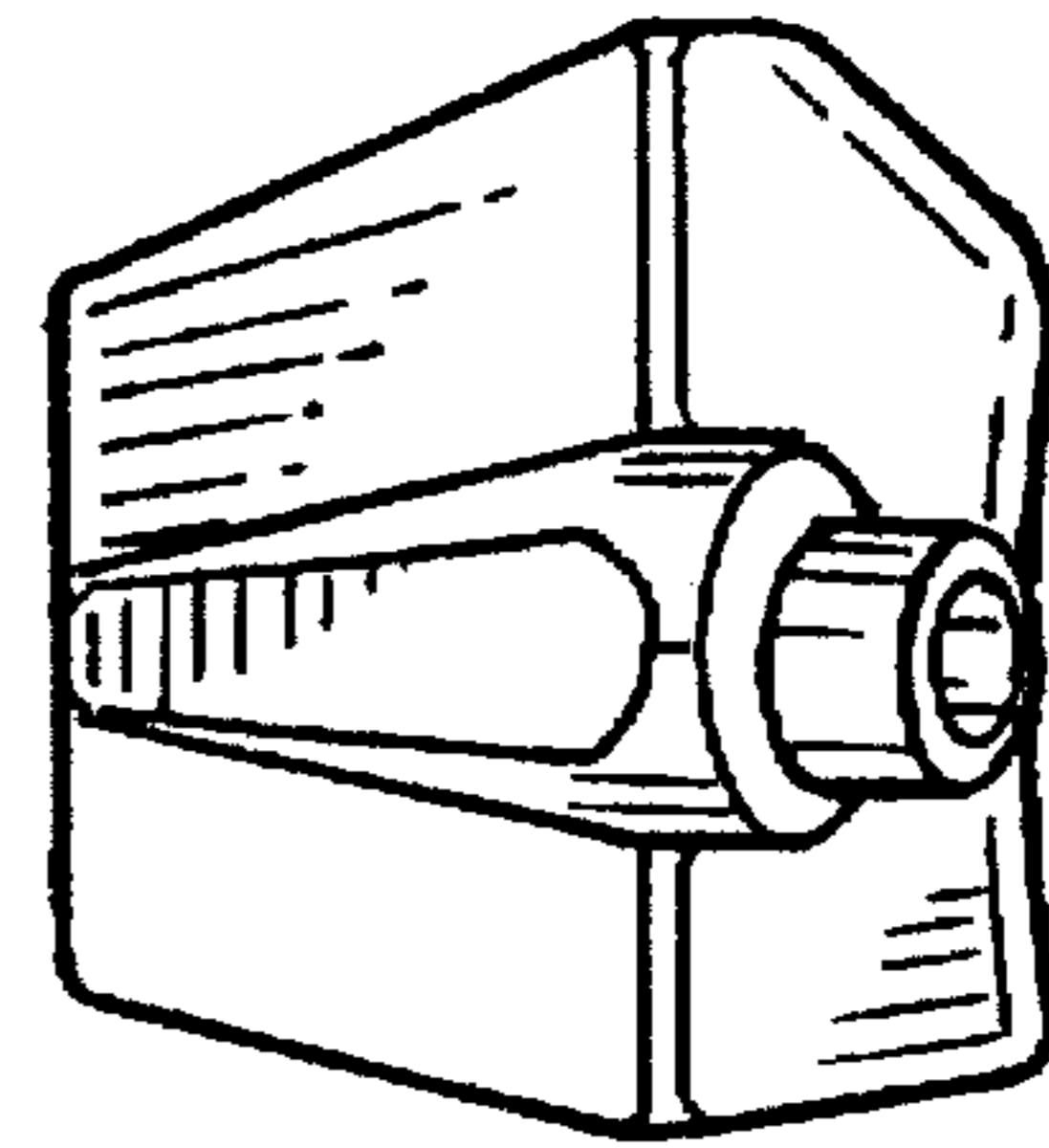

FIG. 4

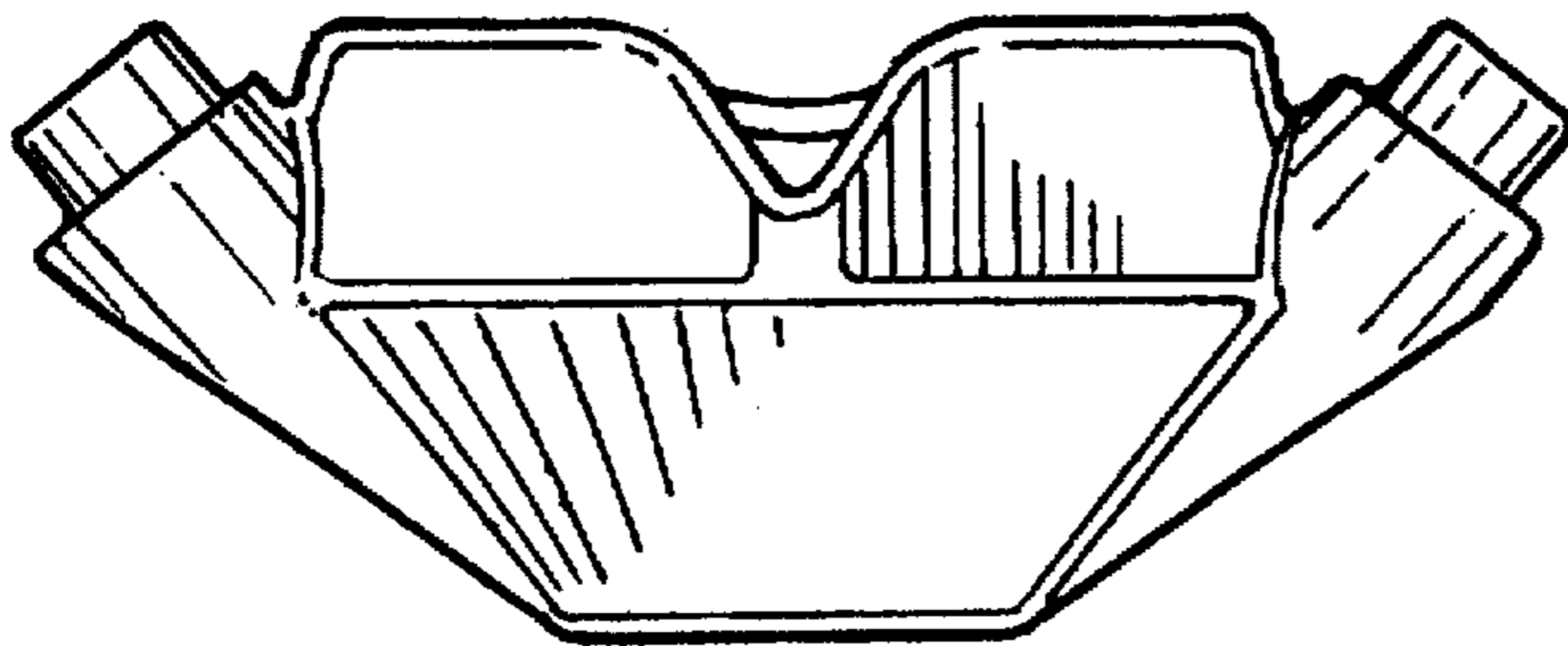

FIG. 3

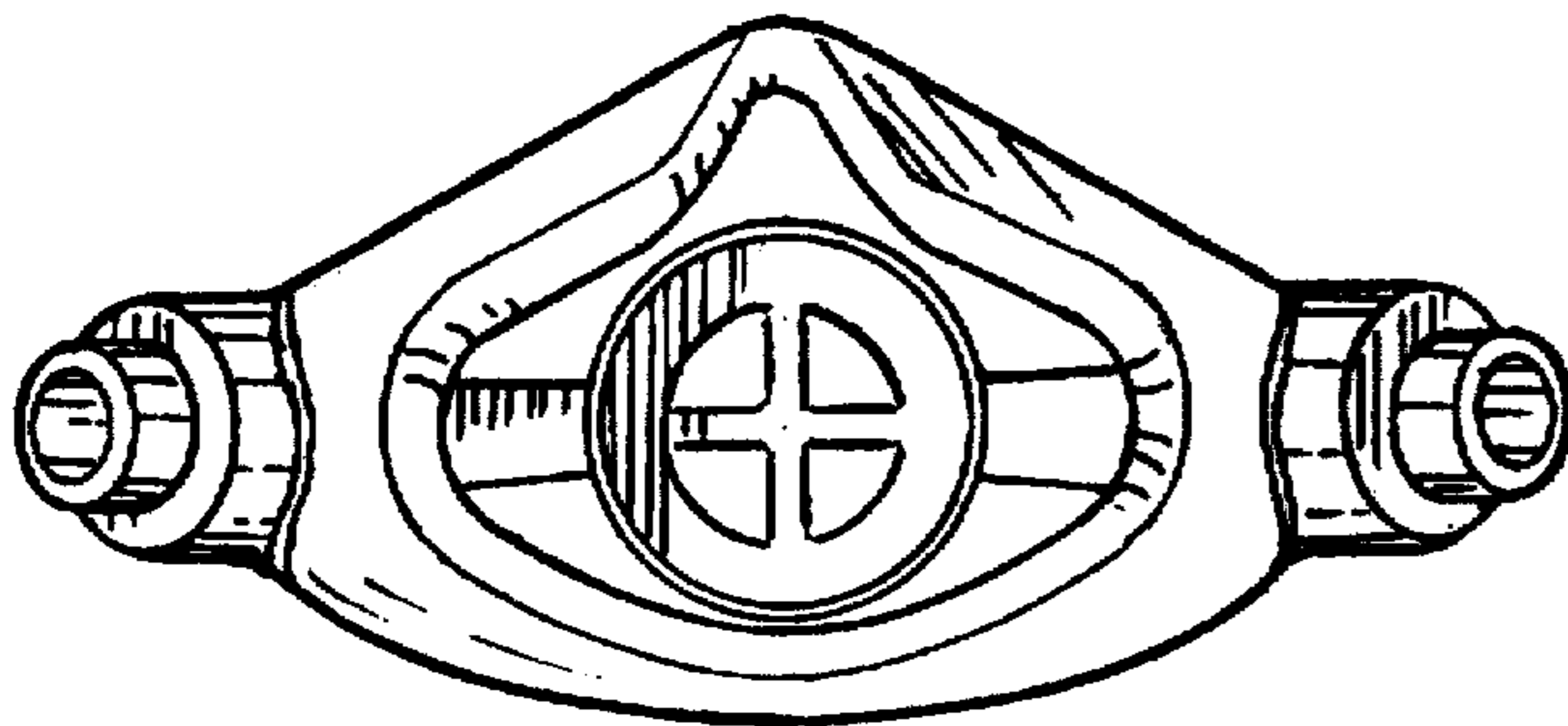

FIG. 5

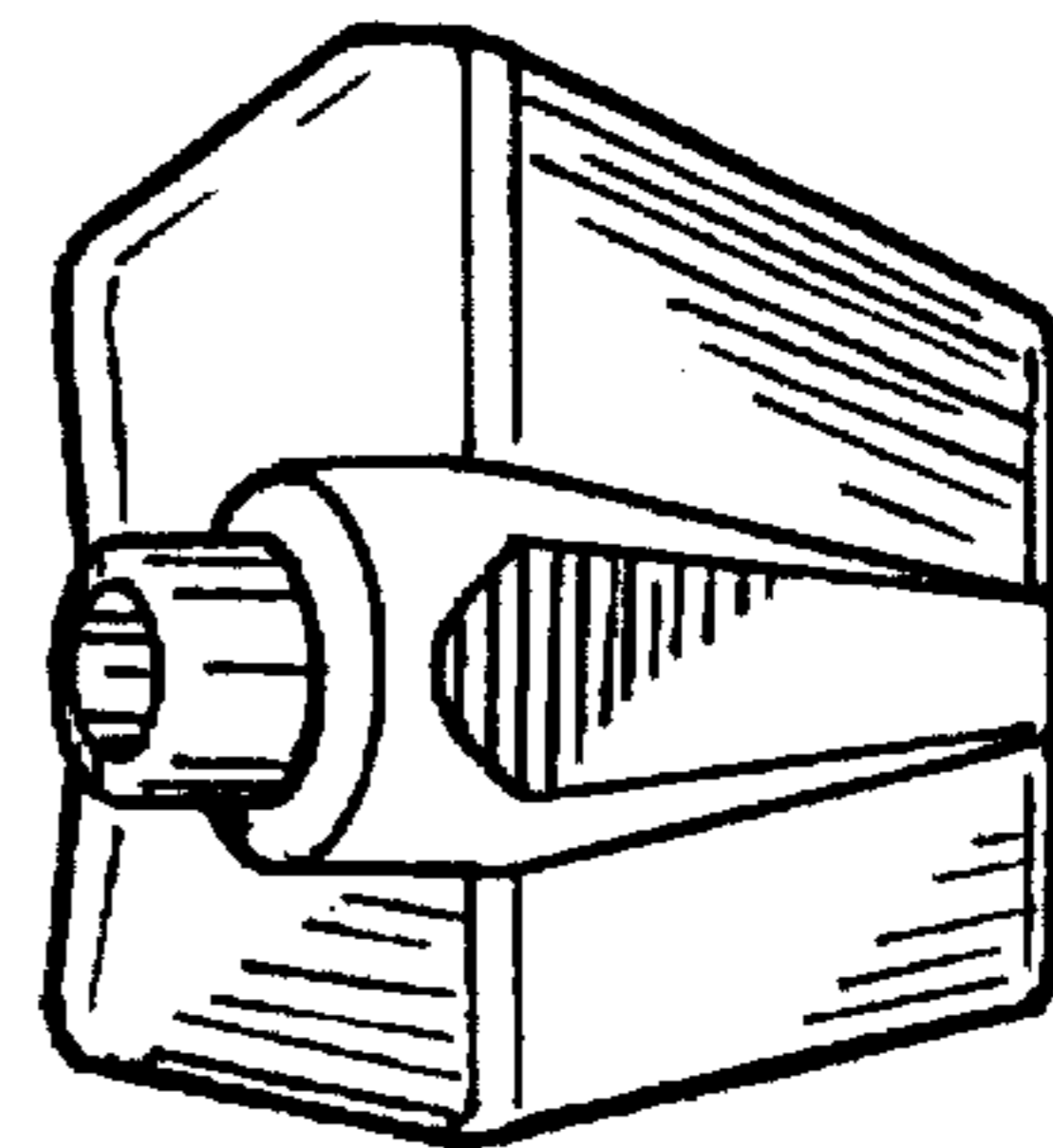

FIG. 6

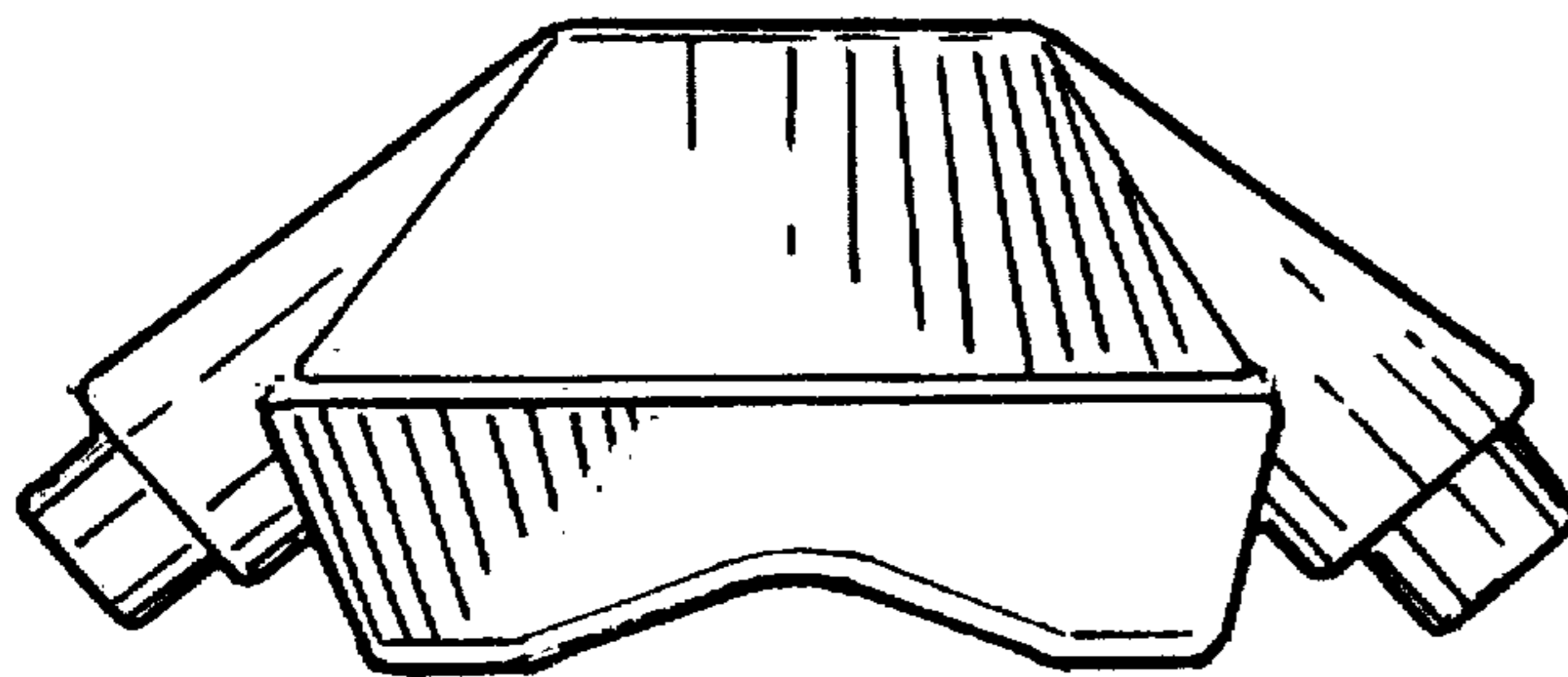

FIG. 7

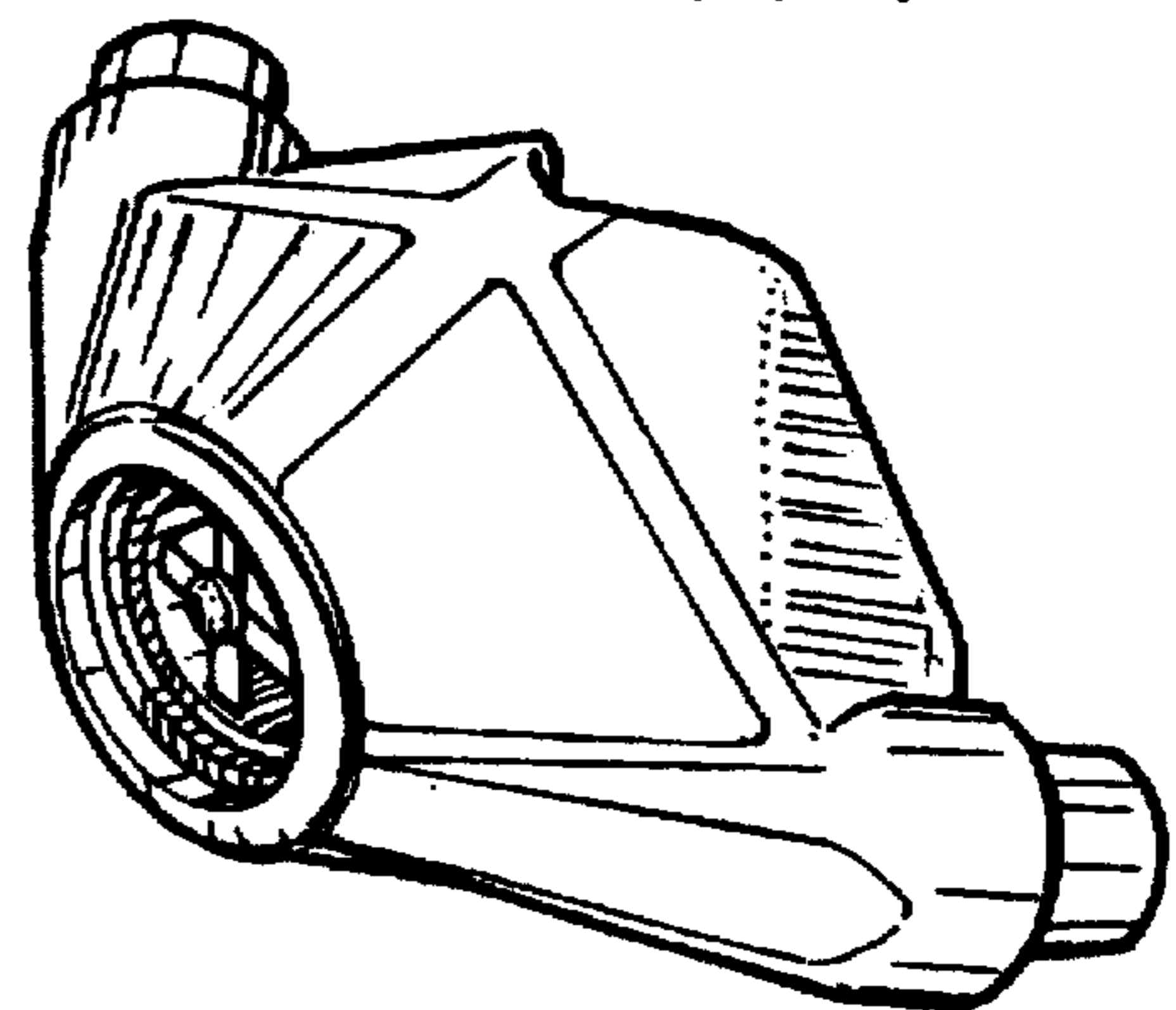

FIG. 1