



US00D390438S

United States Patent [19]
King, Jr.

[11] **Patent Number: Des. 390,438**
[45] **Date of Patent: **Feb. 10, 1998**

[54] **ONE LEGGED TORCHFOOT**
[76] **Inventor: Fate King, Jr.** 329 Diamond St.,
Mound City, Ill. 62963
[**] **Term: 14 Years**
[21] **Appl. No.: 61,135**
[22] **Filed: Oct. 16, 1996**
[51] **LOC (6) Cl. 09-03**
[52] **U.S. Cl. D8/71; D8/354**
[58] **Field of Search D8/71, 354; D6/400;**
D15/140; 72/481.1, 482.93; 81/DIG. 1;
211/70.1, 70.6, 72; 248/121, 152, 174,
176.1, 176.2, 300; 266/58, 66, 76, 77; 269/16;
407/15, 66

D. 376,085	12/1996	King, Jr.	D8/71
2,534,958	12/1950	Deming	266/76
2,596,133	5/1952	Donahue et al.	266/77
2,879,055	3/1959	Johnston	266/58
3,672,651	6/1972	Diepeveen	266/77
4,333,636	6/1982	Wajtkowicz	266/76
4,363,469	12/1982	Cruzan, II	266/77
4,549,725	10/1985	Carroll	266/76
4,681,233	7/1987	Roth	211/70.6
4,830,198	5/1989	Colquitt	211/70.6
5,344,108	9/1994	Heath	248/300
5,482,240	1/1996	Caraher	248/300

Primary Examiner—Antoine Duval Davis
Attorney, Agent, or Firm—Mathew R. P. Perrone, Jr.

[57] **CLAIM**

The ornamental design for a one legged torchfoot, as shown.

DESCRIPTION

FIG. 1 is a rear view of a left handed, rear grip torchfoot showing my new design;
FIG. 2 is a left side elevational view thereof, the broken line showing of a cutting torch being for illustrative purposes only and forming no part of the claimed design;
FIG. 3 is a rear elevational view thereof;
FIG. 4 is a front elevational view thereof;
FIG. 5 is a top plan view thereof; and,
FIG. 6 is a bottom plan view elevational view thereof.

1 Claim, 3 Drawing Sheets

[56] **References Cited**
U.S. PATENT DOCUMENTS

D. 31,665	10/1899	McKay	D8/354
D. 205,793	9/1966	Holmes	D8/354
D. 212,446	10/1968	McCarthy	D8/354
D. 218,015	7/1970	Symington	D8/354
D. 236,251	8/1975	Cunningham	D8/354
D. 285,045	8/1986	Mahoney	D8/354
D. 291,654	9/1987	Foster, Jr.	D8/354
D. 362,174	9/1995	Sachs	D8/354
D. 373,520	9/1996	King, Jr.	D8/71

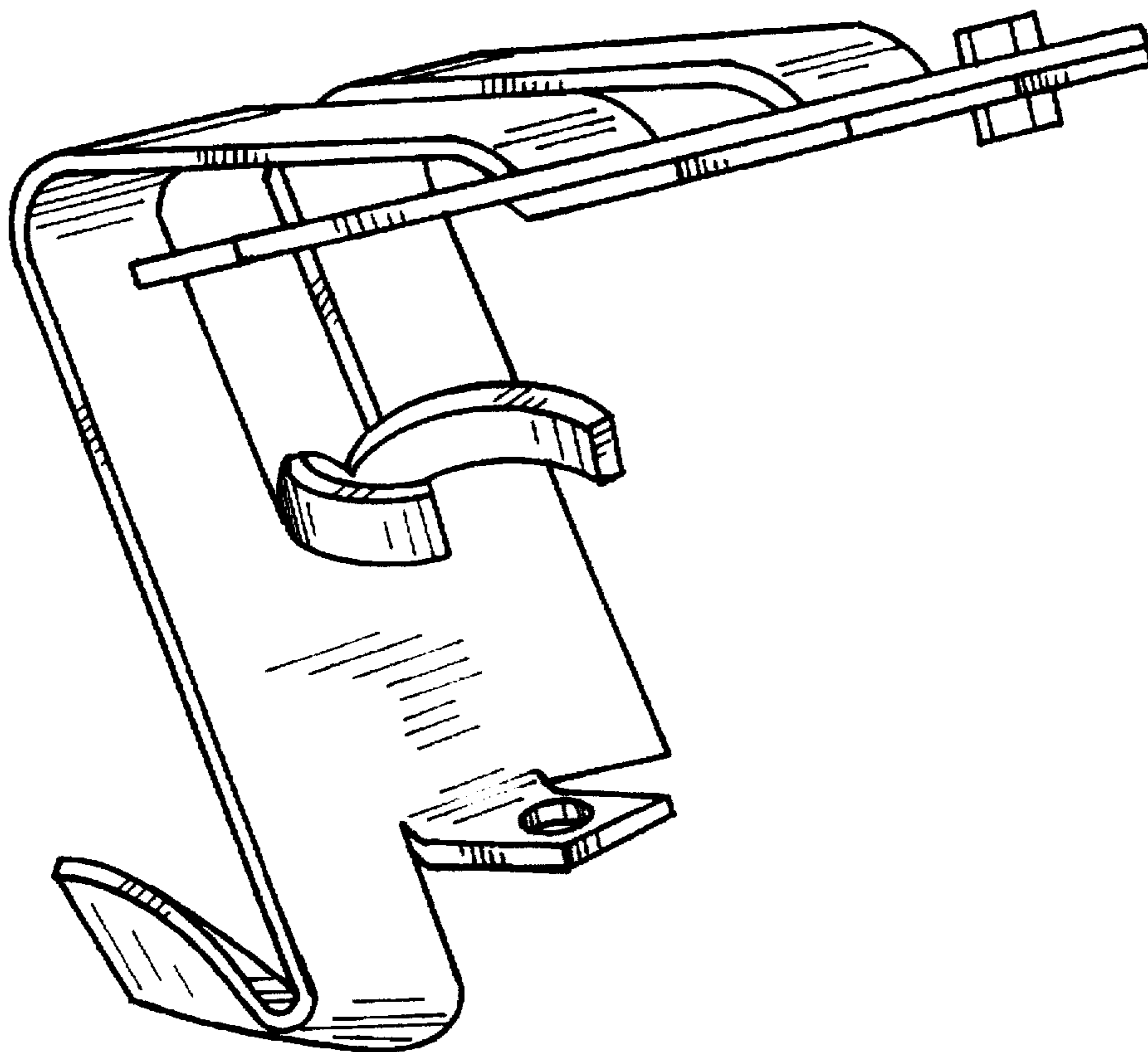

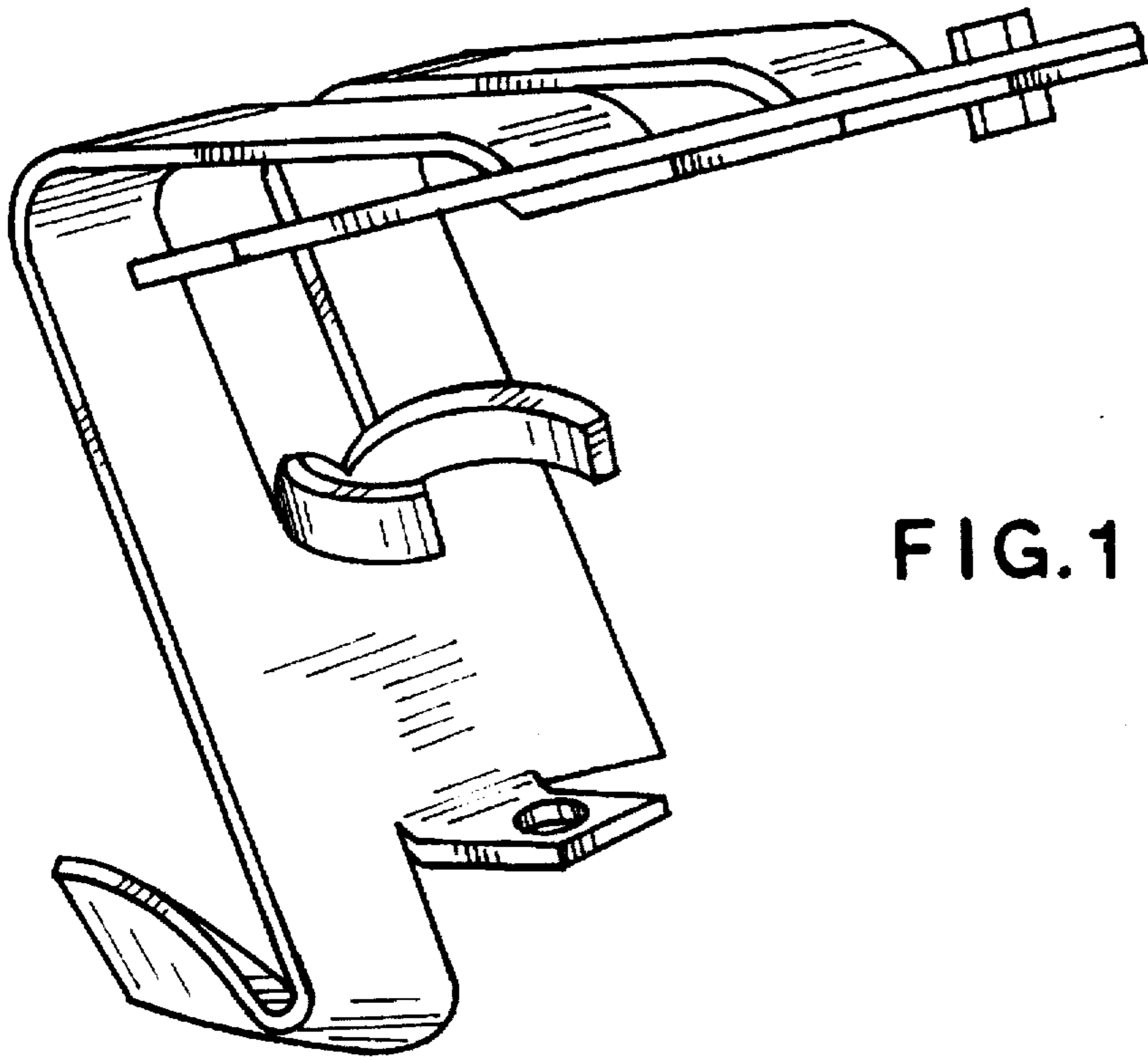

FIG. 1

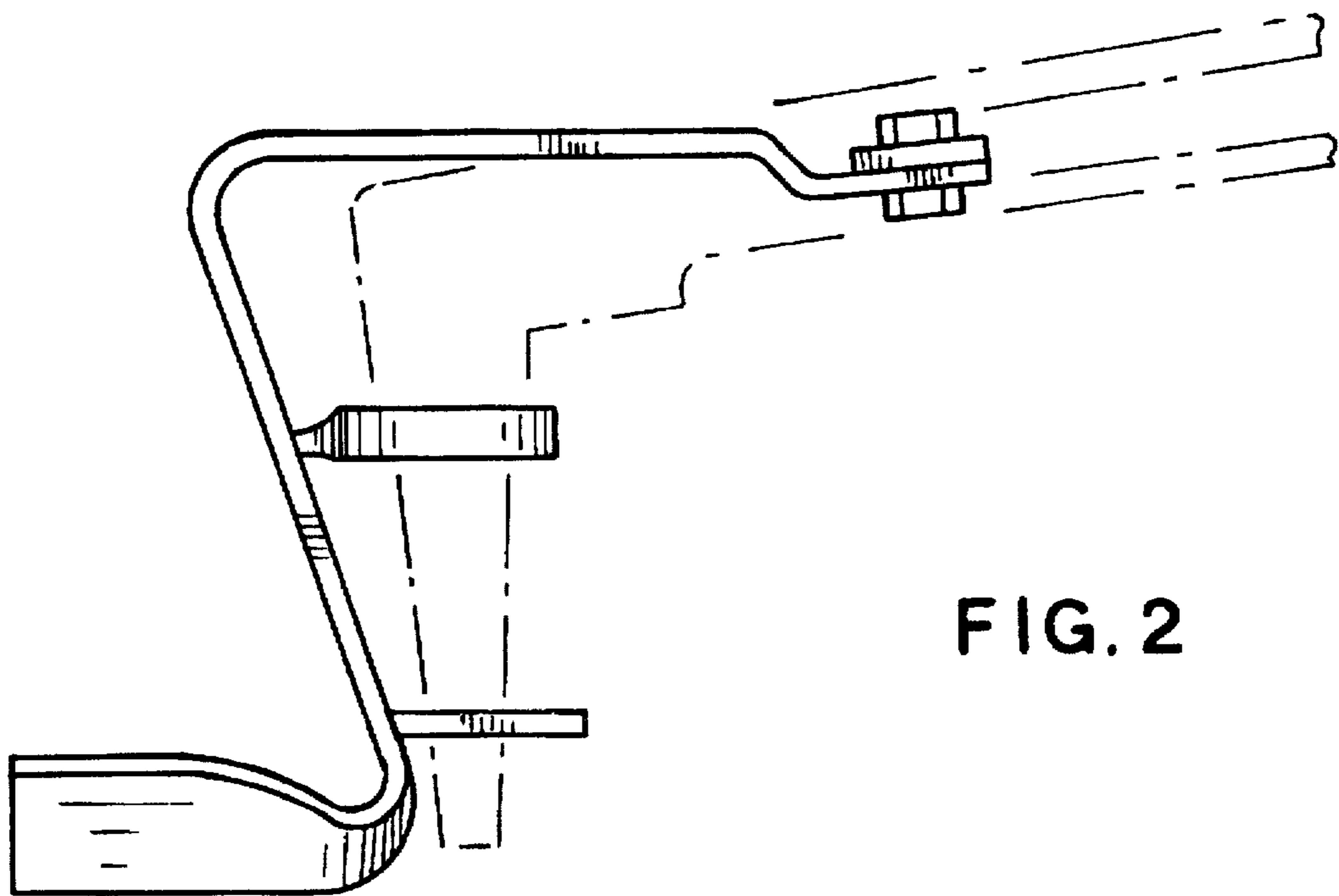

FIG. 2

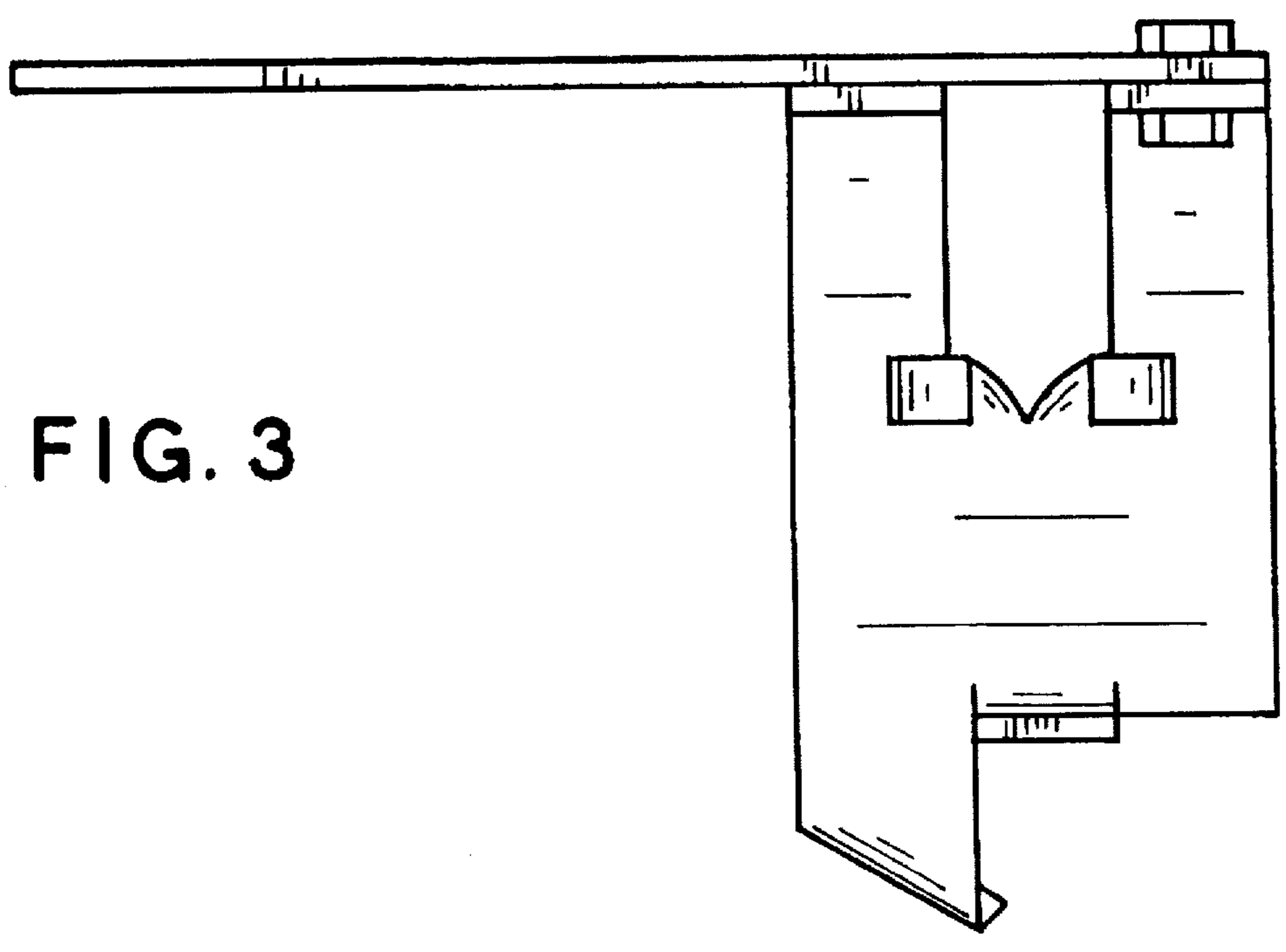

FIG. 3

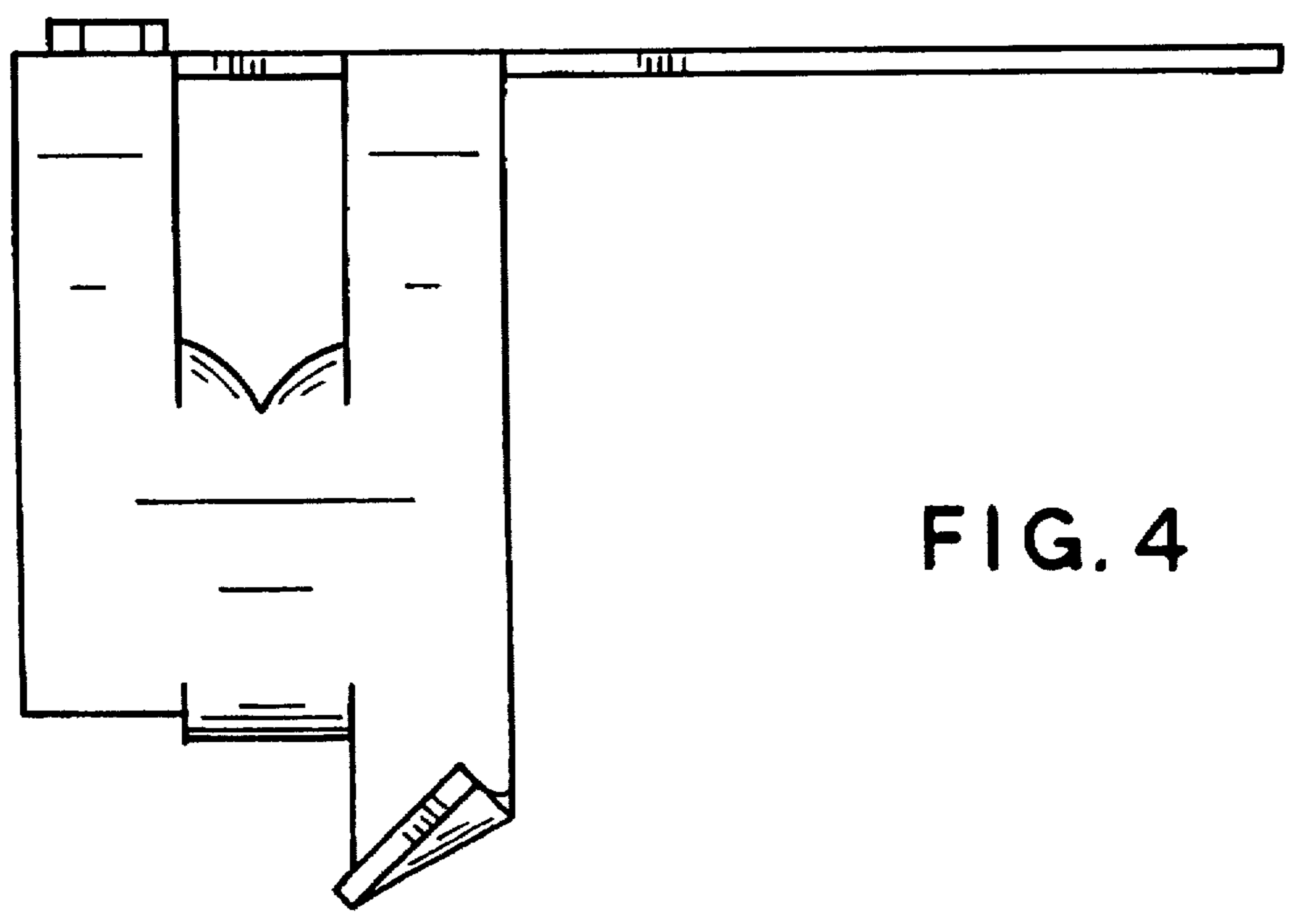

FIG. 4

FIG. 5

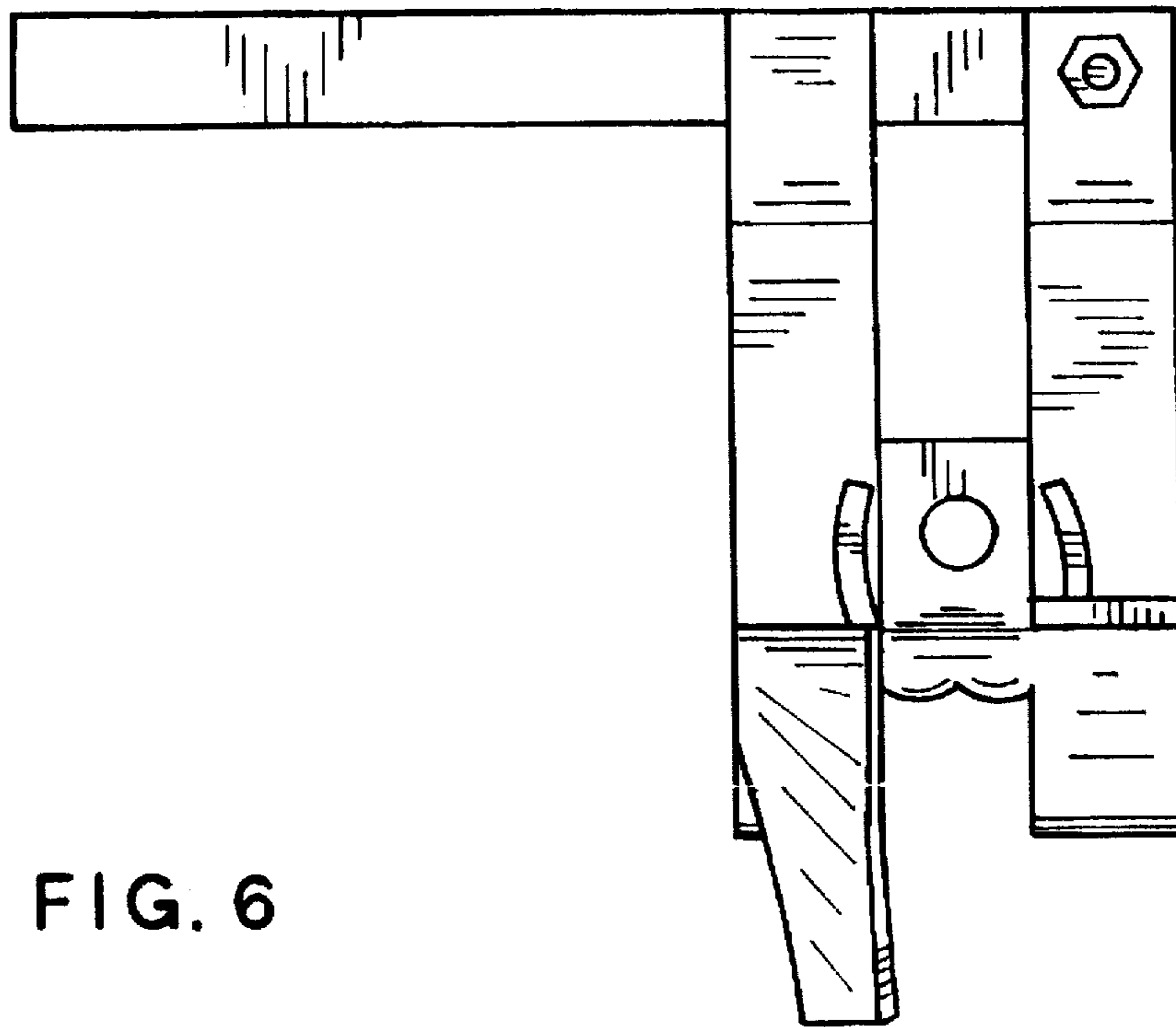
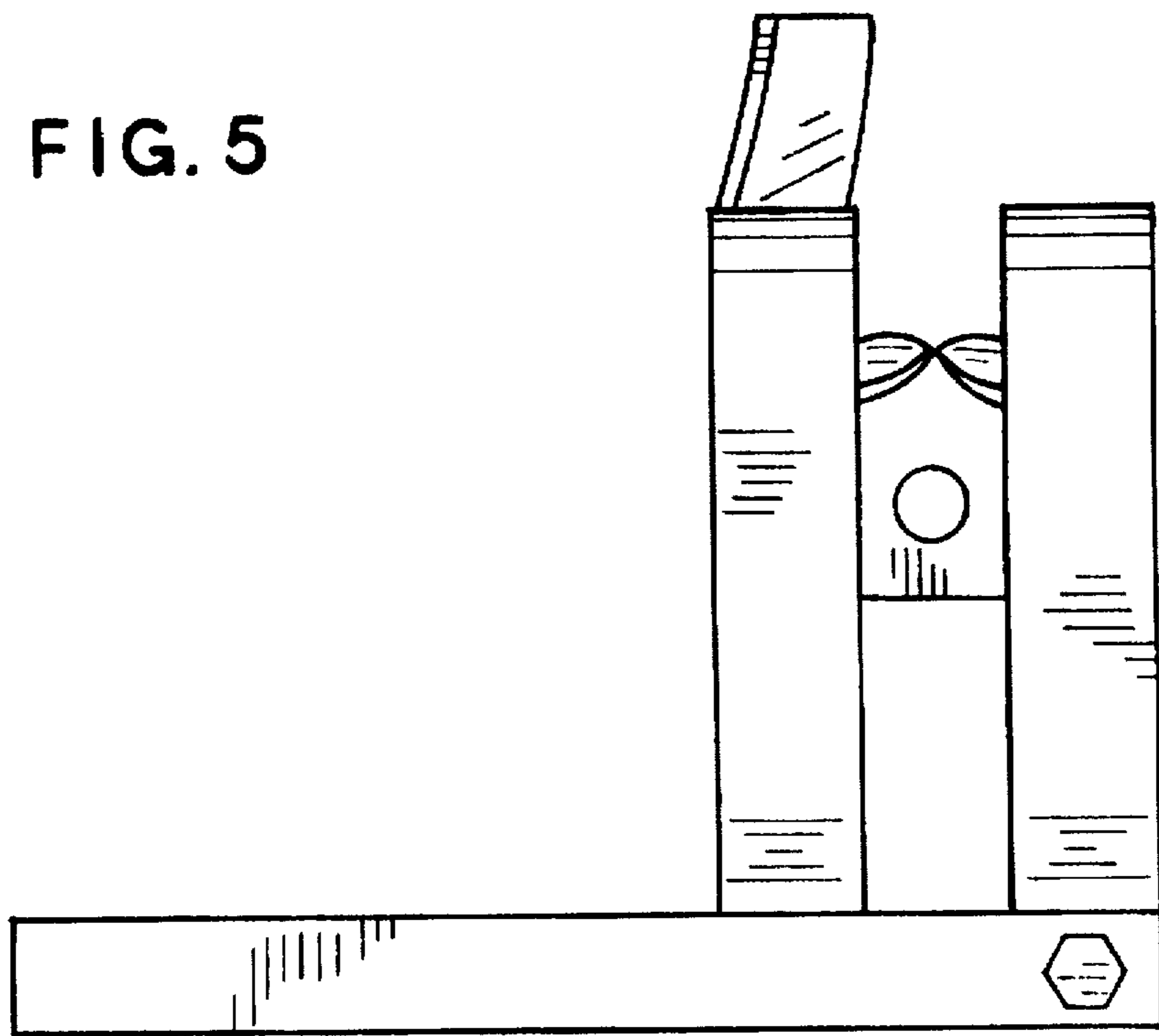

FIG. 6