



US00D390376S

United States Patent [19] Chang

[11] Patent Number: **Des. 390,376**
[45] Date of Patent: ****Feb. 10, 1998**

[54] OFFICE DESK

[76] Inventor: **Chien-Kuo Chang**, Fl. 10-2, No. 447,
Sec. 3, Wen-Hsin Road, Taichung,
Taiwan

[**] Term: **14 Years**

[21] Appl. No.: **65,122**

[22] Filed: **Jan. 21, 1997**

[51] LOC (6) Cl. **06-04**

[52] U.S. Cl. **D6/424; D6/425; D6/426**

[58] Field of Search **D6/422-428, 474;
312/194-196**

[56] References Cited

U.S. PATENT DOCUMENTS

D. 327,790	7/1992	Sharar	D6/422
D. 330,644	11/1992	Bellini et al.	D6/422
D. 334,489	4/1993	Greutmann et al.	D6/423
D. 339,257	9/1993	Scharer et al.	D6/474
D. 346,912	5/1994	Mezger	D6/423
D. 371,699	7/1996	Muller-Deisig et al.	D6/423 X

OTHER PUBLICATIONS

Kinetics, p. 4; desk at center of page, Oct. 1989.
"Dynamics", p. 4; desk at top of page, Mar. 1, 1996.

Primary Examiner—Carmen H. Vales-Lado
Attorney, Agent, or Firm—Charles E. Baxley, Esq.

[57] CLAIM

The ornamental design for an office desk, as shown and described.

DESCRIPTION

FIG. 1 is a perspective view of an office desk showing my new design;

FIG. 2 is a front elevational view thereof;

FIG. 3 is a rear elevational view thereof;

FIG. 4 is a left side elevational view thereof;

FIG. 5 is a right side elevational view thereof;

FIG. 6 is a top plan view thereof; and,

FIG. 7 is a bottom plan view thereof.

1 Claim, 6 Drawing Sheets

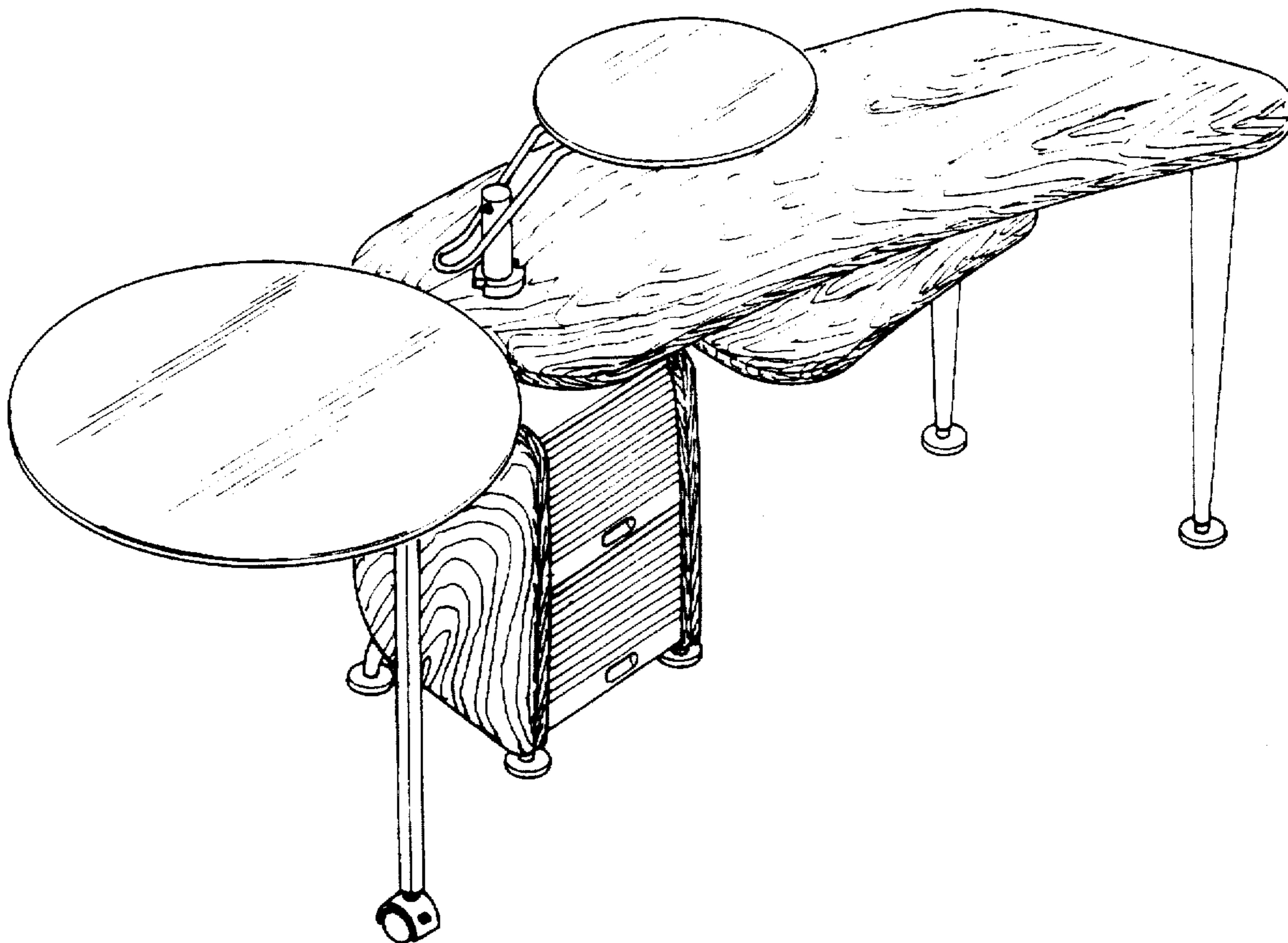

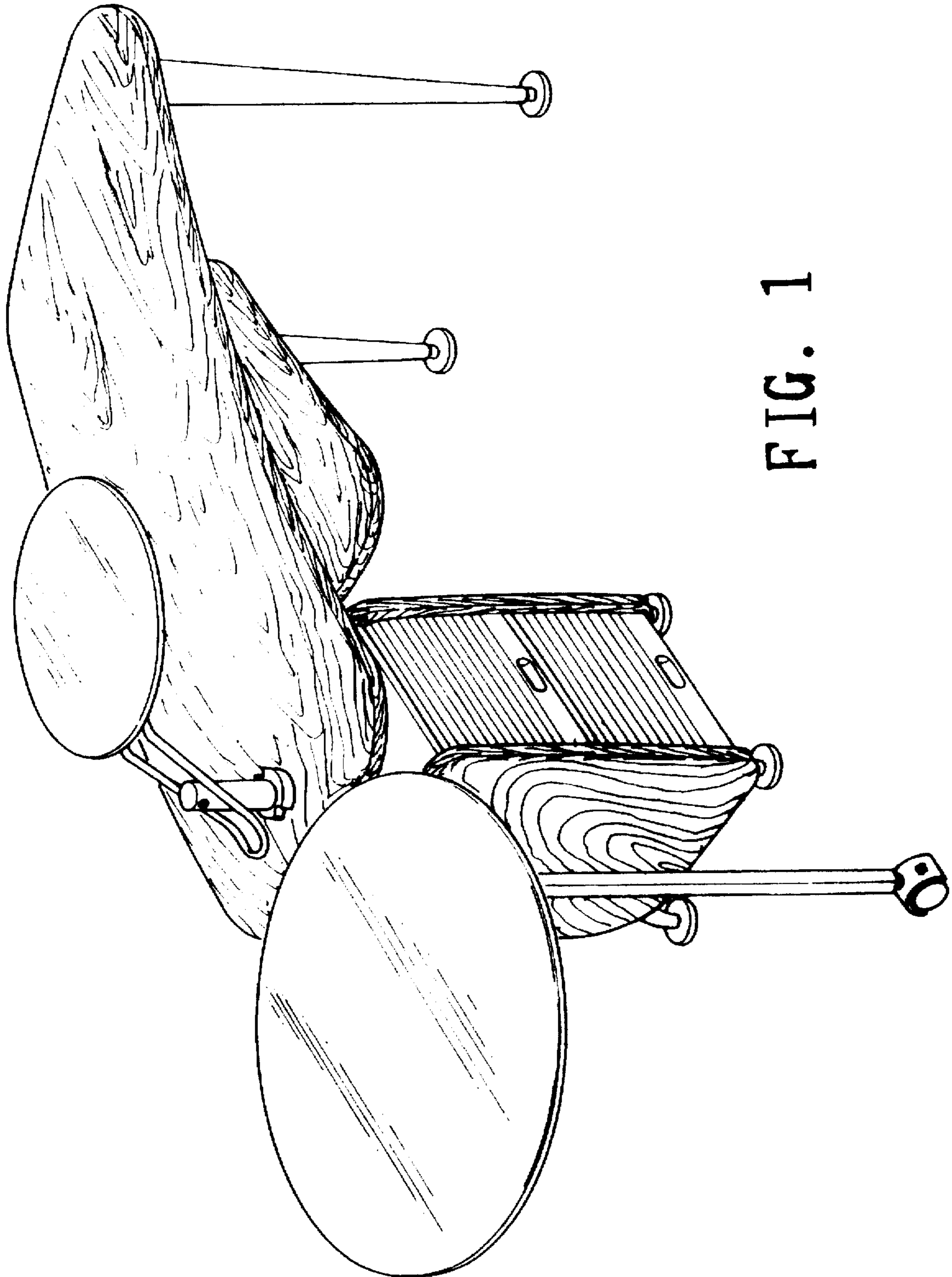

FIG. 1

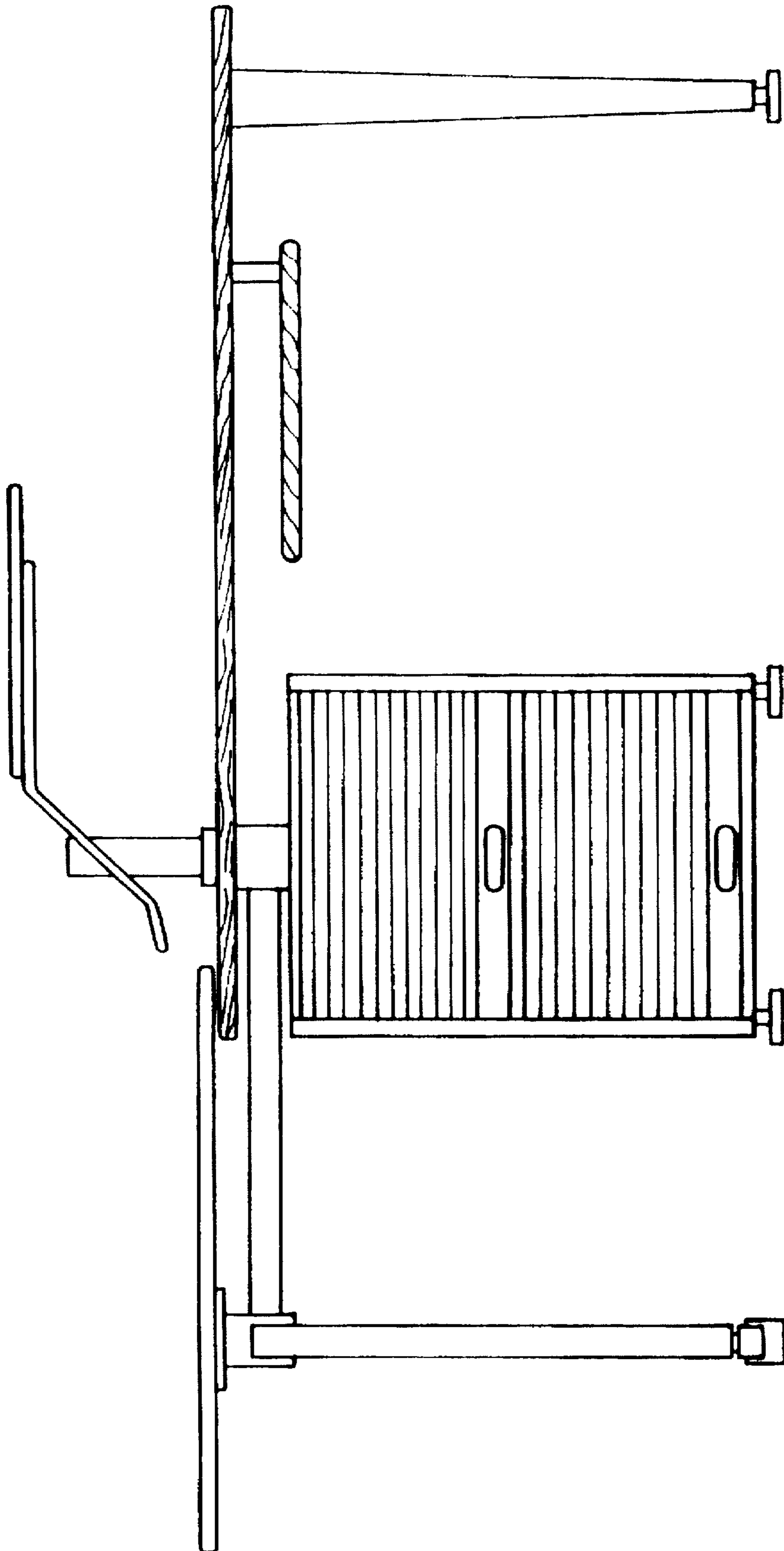

FIG. 2

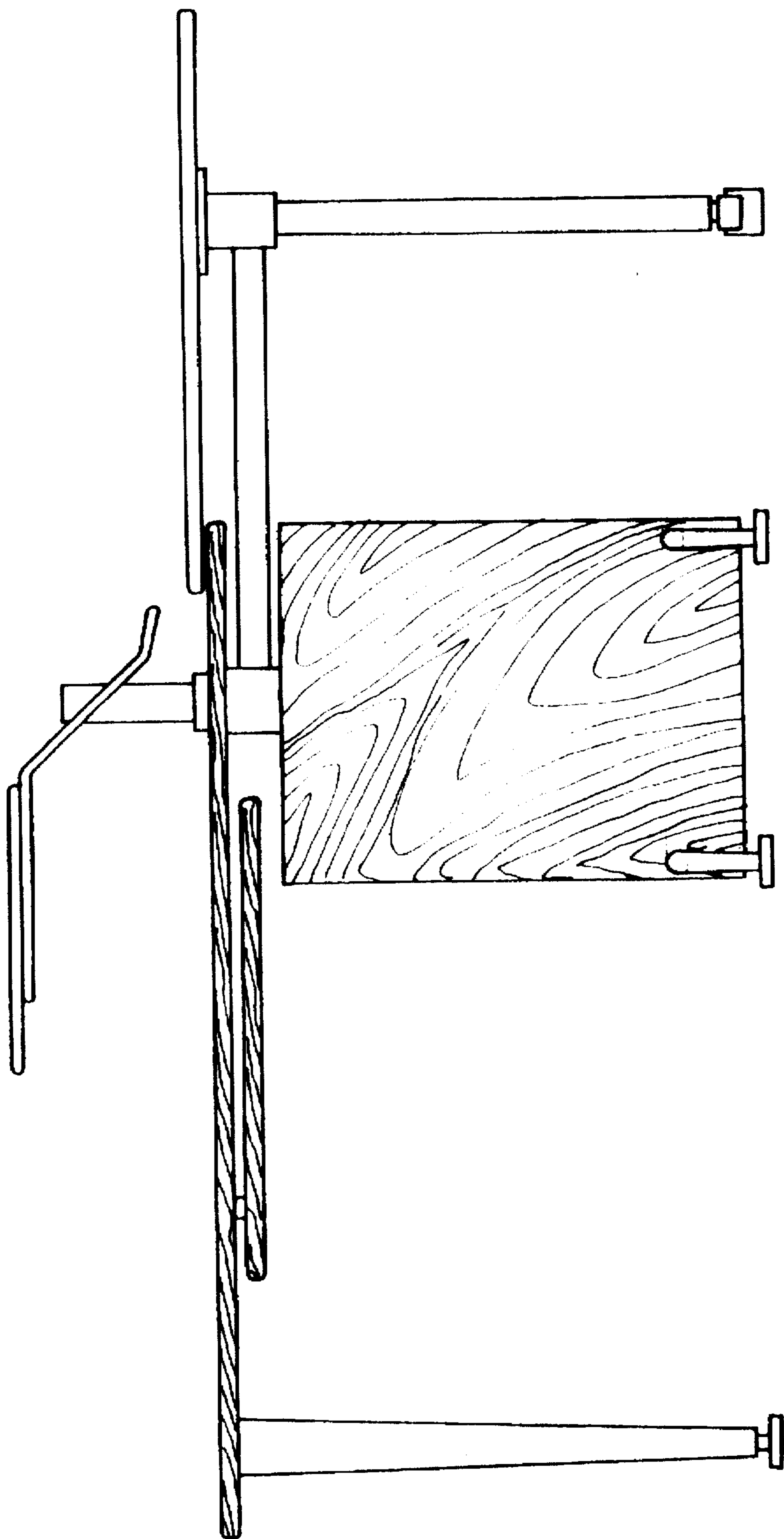

FIG. 3

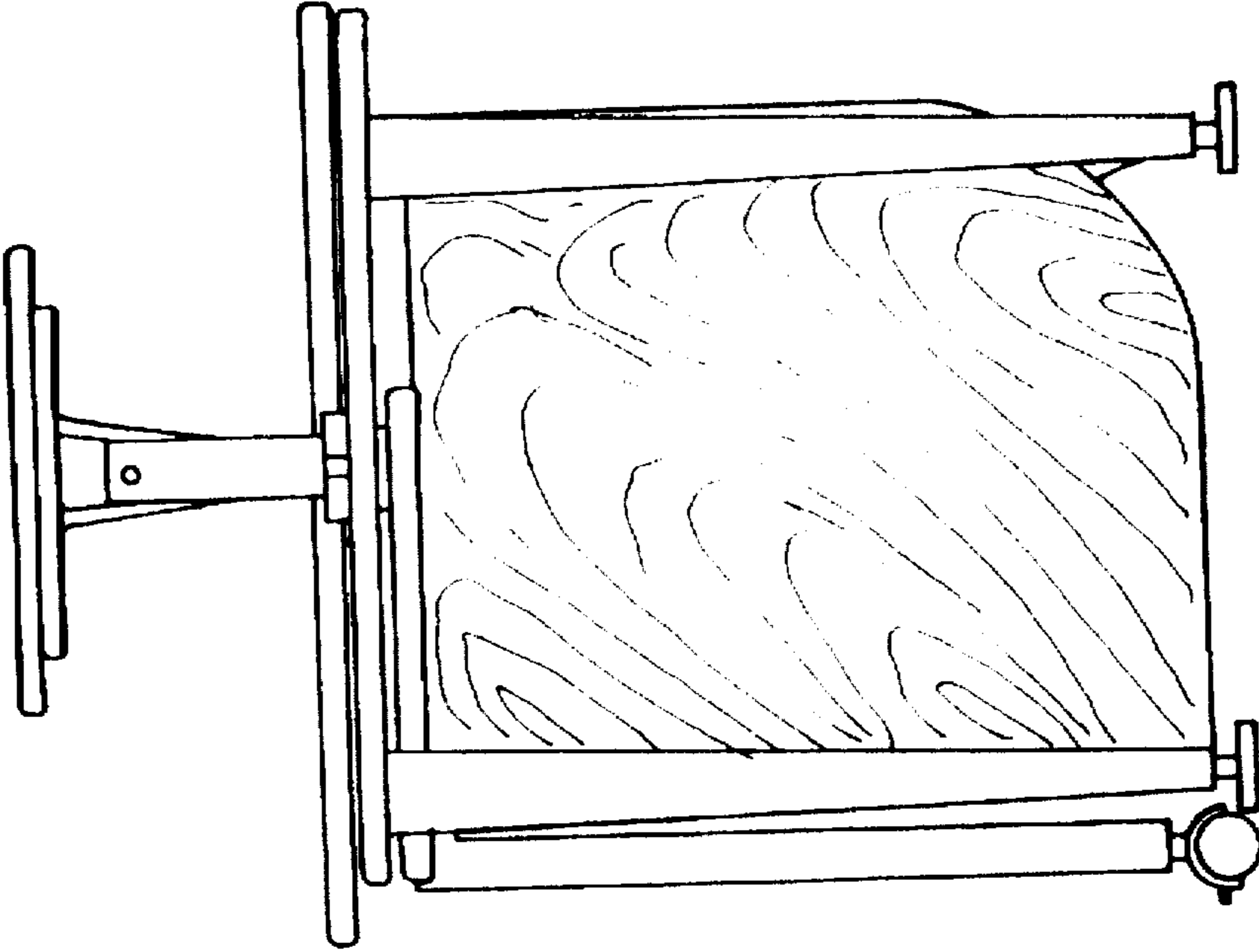

FIG. 5

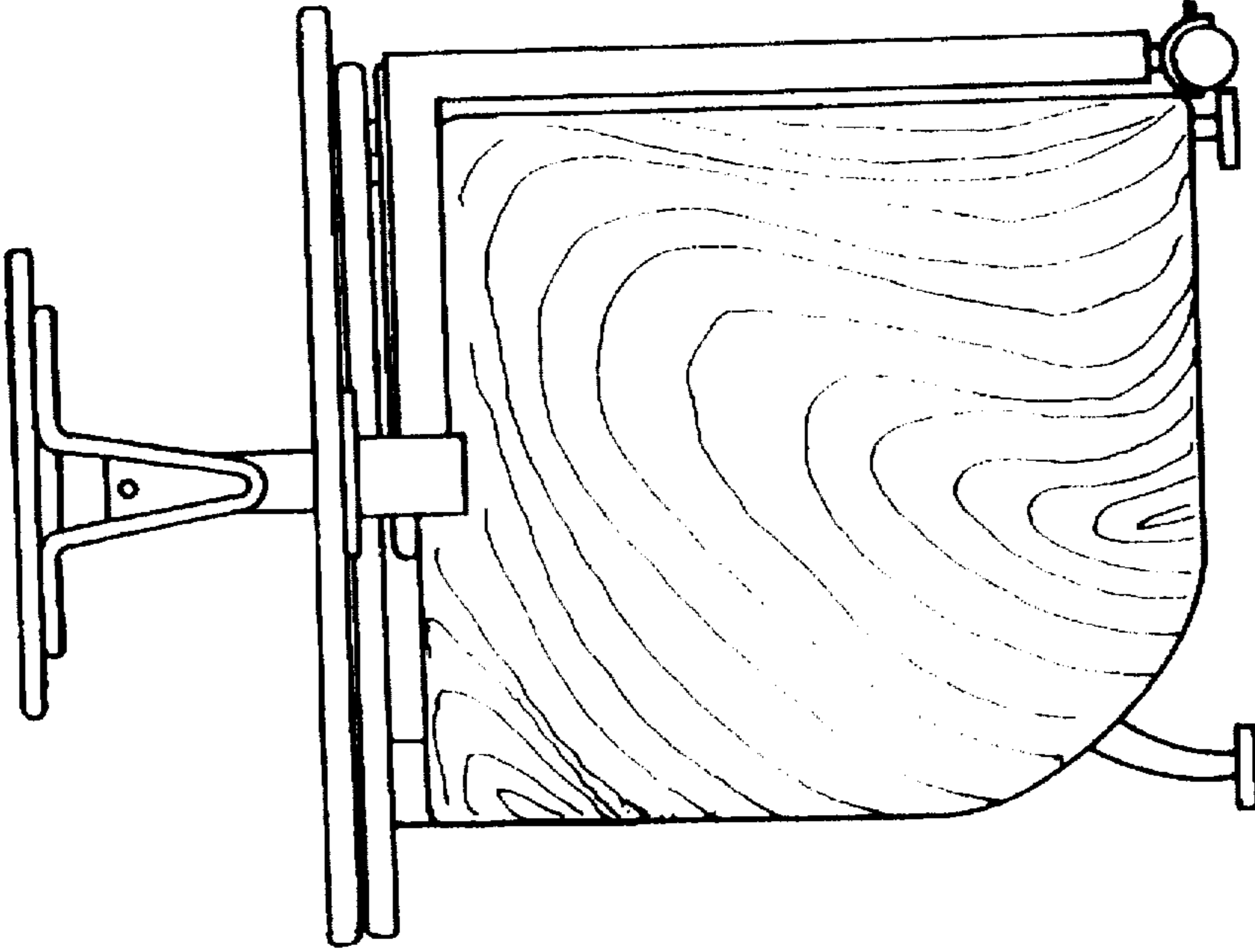

FIG. 4

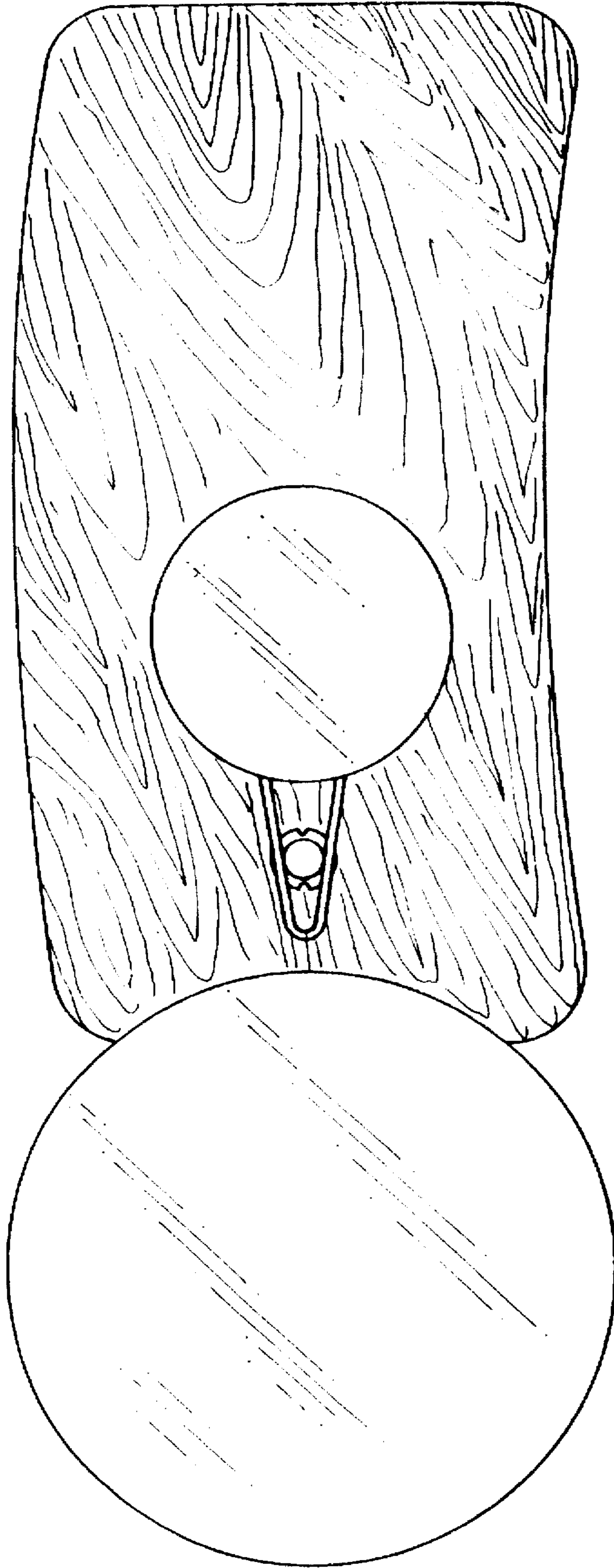

FIG. 6

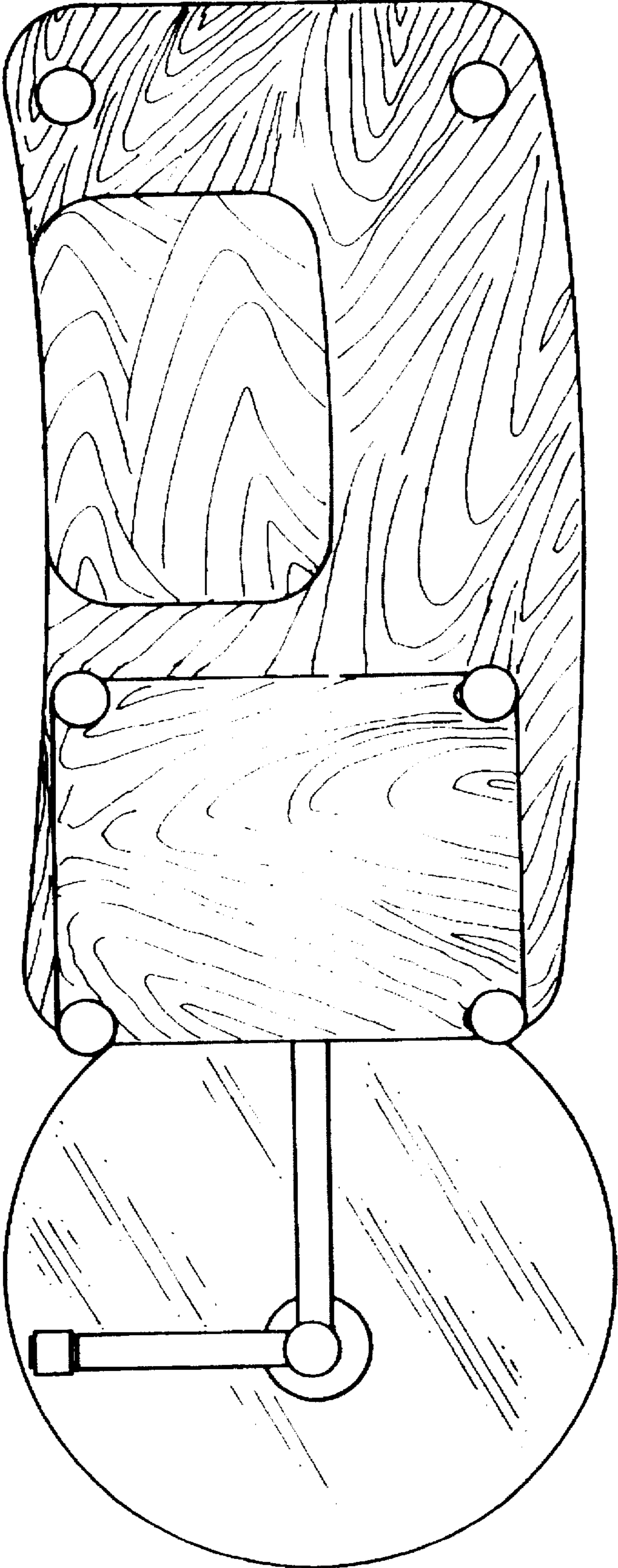

FIG. 7