



US00D390295S

United States Patent [19]
Burrows

[11] **Patent Number: Des. 390,295**
[45] **Date of Patent: **Feb. 3, 1998**

- [54] **WOOD-TYPE HEAD FOR A GOLF CLUB**
- [76] **Inventor: Bruce D. Burrows, 25555 W. Avenue Stanford, Valencia, Calif. 91355-1101**
- [**] **Term: 14 Years**
- [21] **Appl. No.: 68,735**
- [22] **Filed: Mar. 31, 1997**
- [51] **LOC (6) Cl. 21-02**
- [52] **U.S. Cl. D21/214**
- [58] **Field of Search D21/214, 217-219; 473/327, 328, 343, 344**

Primary Examiner—Raphael Barkai
Assistant Examiner—Mitchell I. Siegel
Attorney, Agent, or Firm—Kelly Bauersfeld Lowry & Kelley, LLP

[57] **CLAIM**

The ornamental design for a wood-type head for a golf club, as shown and described.

DESCRIPTION

FIG. 1 is a perspective view showing the front, top and left sides of a wood-type head for a golf club embodying the new design;
 FIG. 2 is a front elevational view thereof;
 FIG. 3 is a left side elevational view thereof;
 FIG. 4 is a right side elevational view thereof;
 FIG. 5 is a rear elevational view thereof;
 FIG. 6 is a top plan view thereof;
 FIG. 7 is a bottom plan view thereof;
 FIG. 8 is a bottom plan view of an alternative form of my new design, the front and rear elevational views, the top plan view, and the right side elevational view being identical to the embodiment of FIGS. 1-7; and,
 FIG. 9 is a left side elevational view of the embodiment of FIG. 8.
 The broken line showing of a fragmented shaft is for illustrative purposes only and forms no part of the claimed design.

[56] **References Cited**

U.S. PATENT DOCUMENTS

D. 231,625	5/1974	Werner	D21/29
D. 257,872	1/1981	MacDougall	D21/219
D. 257,873	1/1981	MacDougall	D21/219
D. 318,087	7/1991	Helmstetter	D21/214
D. 356,356	3/1995	Jacobs	D21/219
D. 364,666	11/1995	Nagy	D21/219
D. 366,919	2/1996	Jacobs	D21/219
D. 368,752	4/1996	Patten	D21/219
4,511,145	4/1985	Schmidt	483/346
5,042,806	8/1991	Helmstetter	473/311
5,611,741	3/1997	Schmidt et al.	473/328

1 Claim, 5 Drawing Sheets

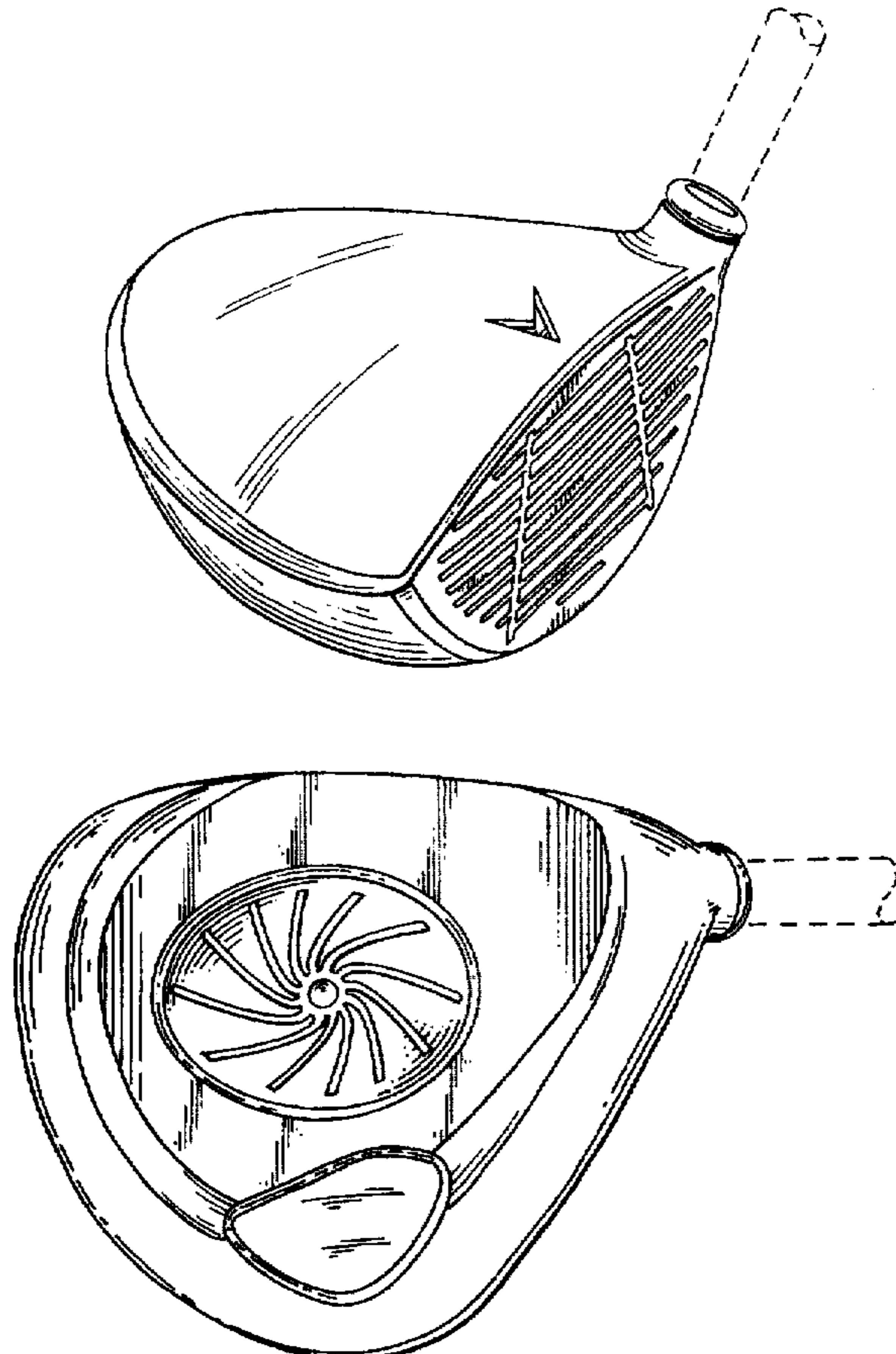

FIG. 1

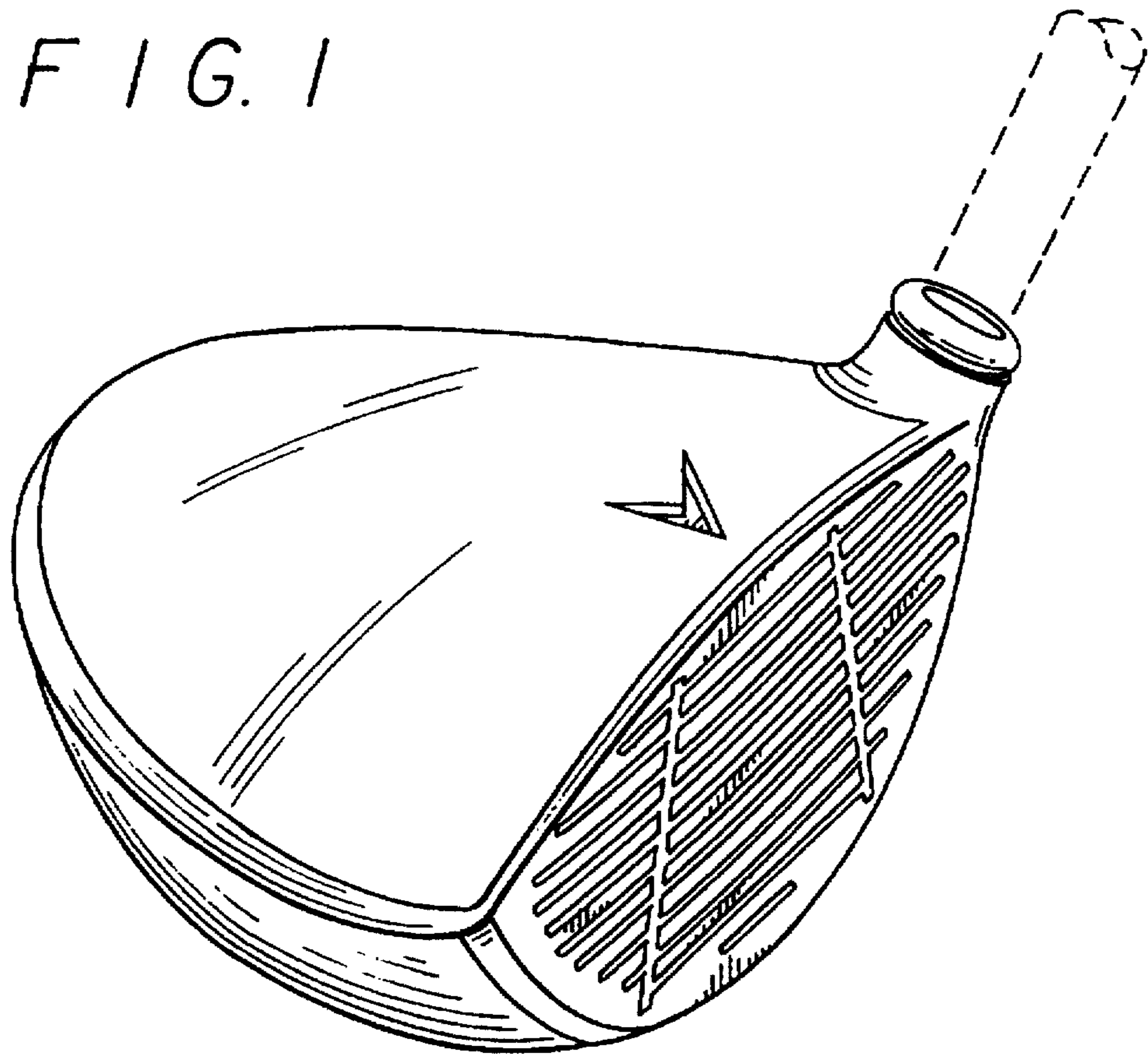

FIG. 2

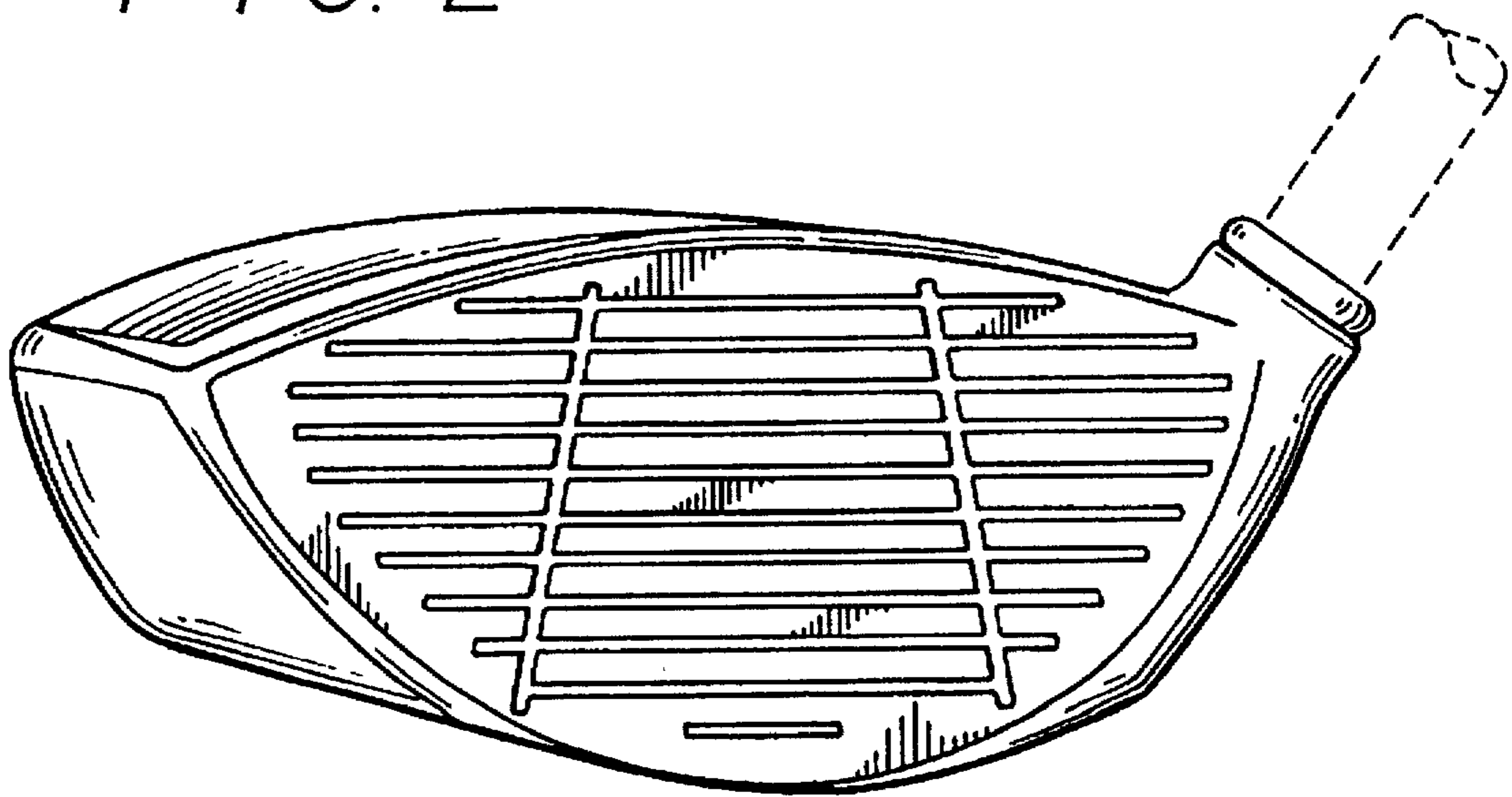

FIG. 3

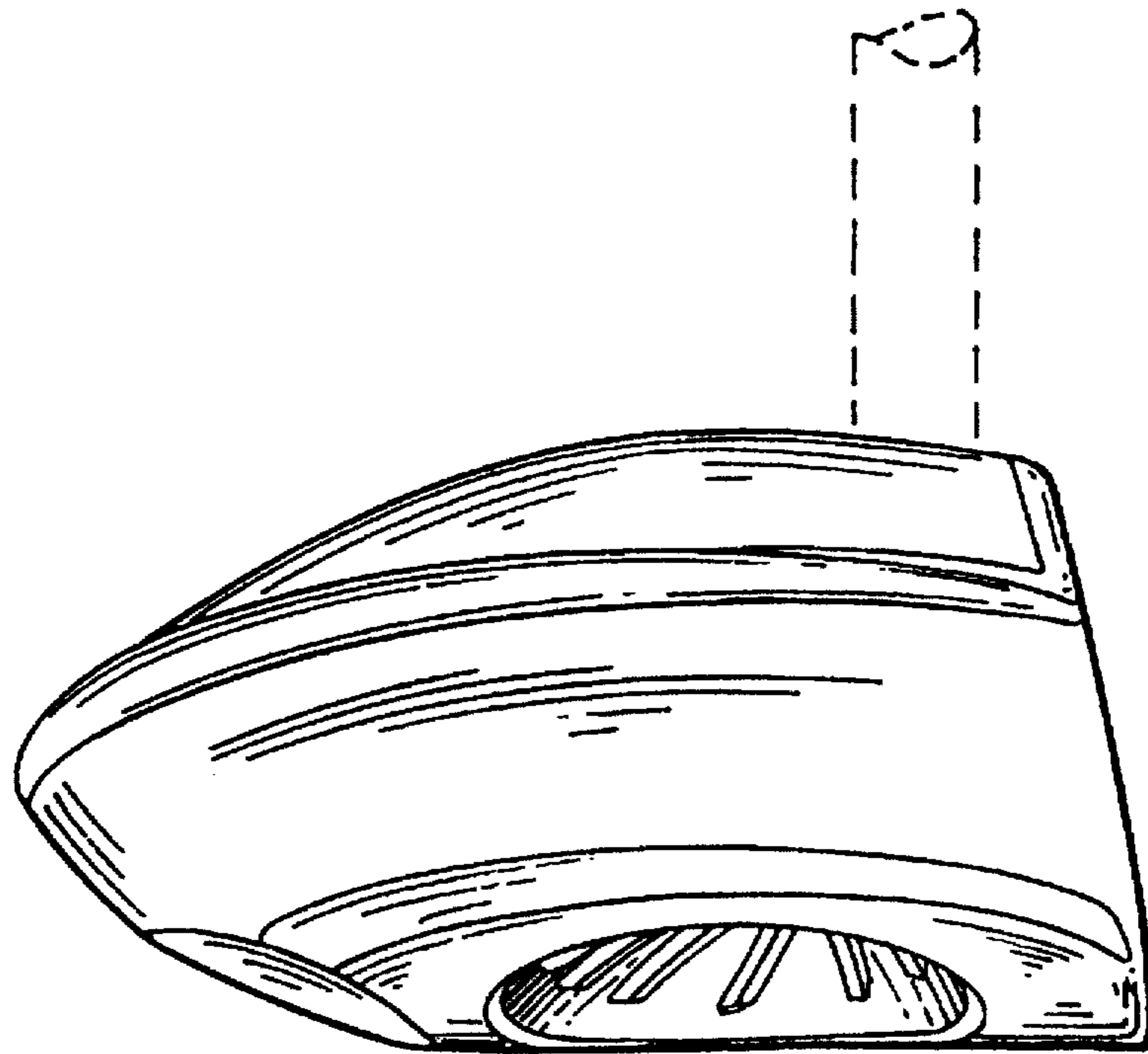

FIG. 4

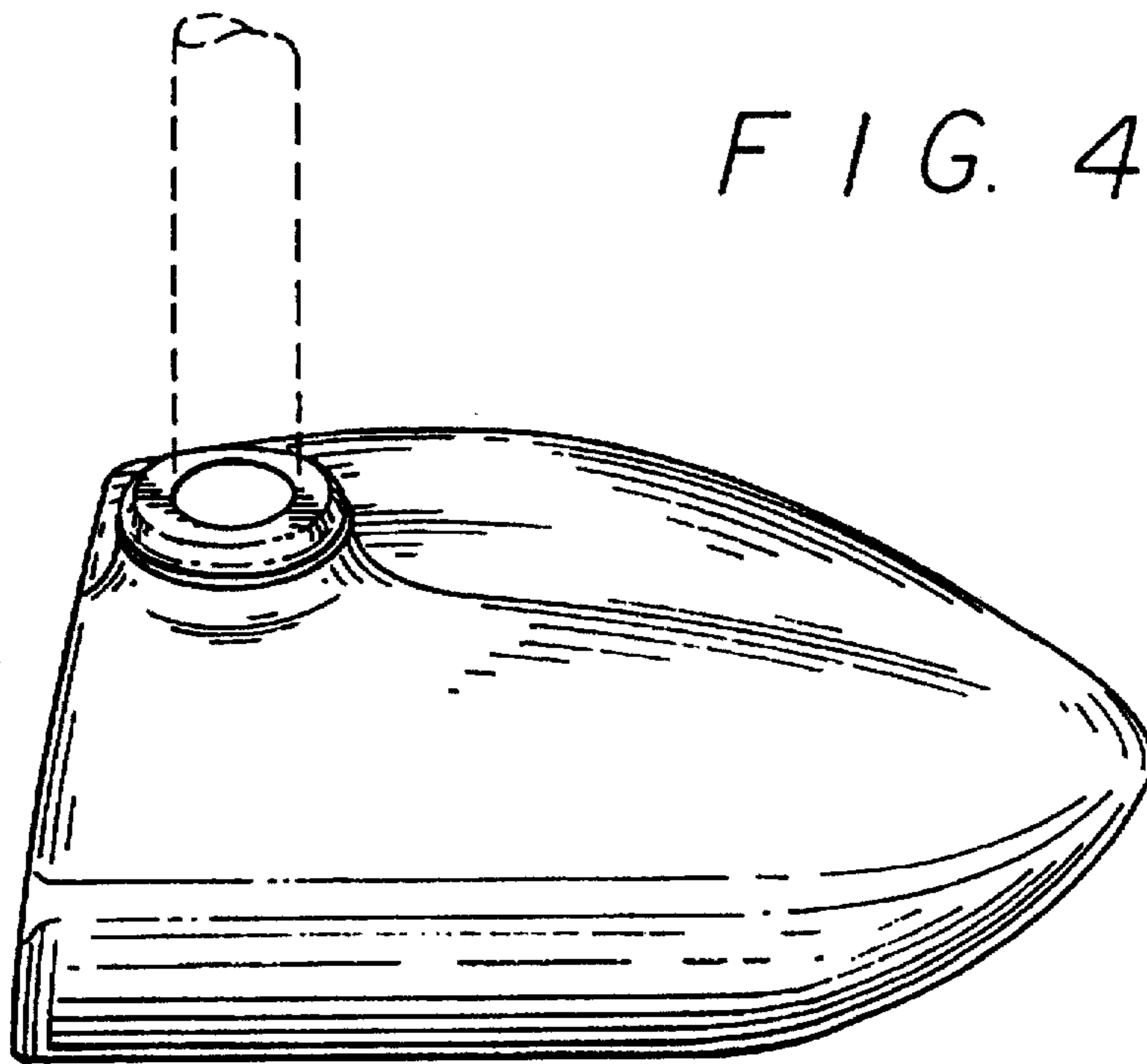
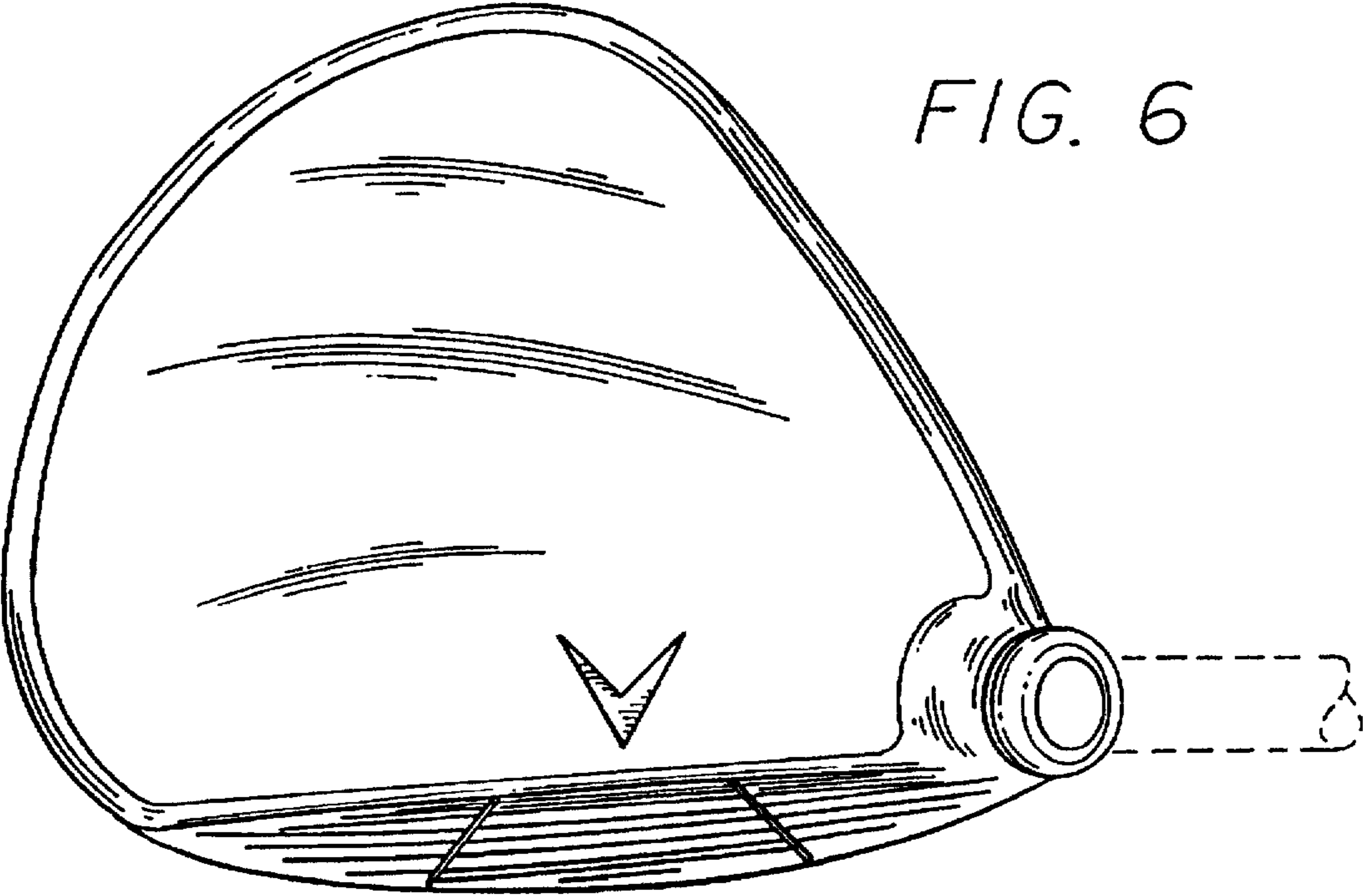

FIG. 5



FIG. 6



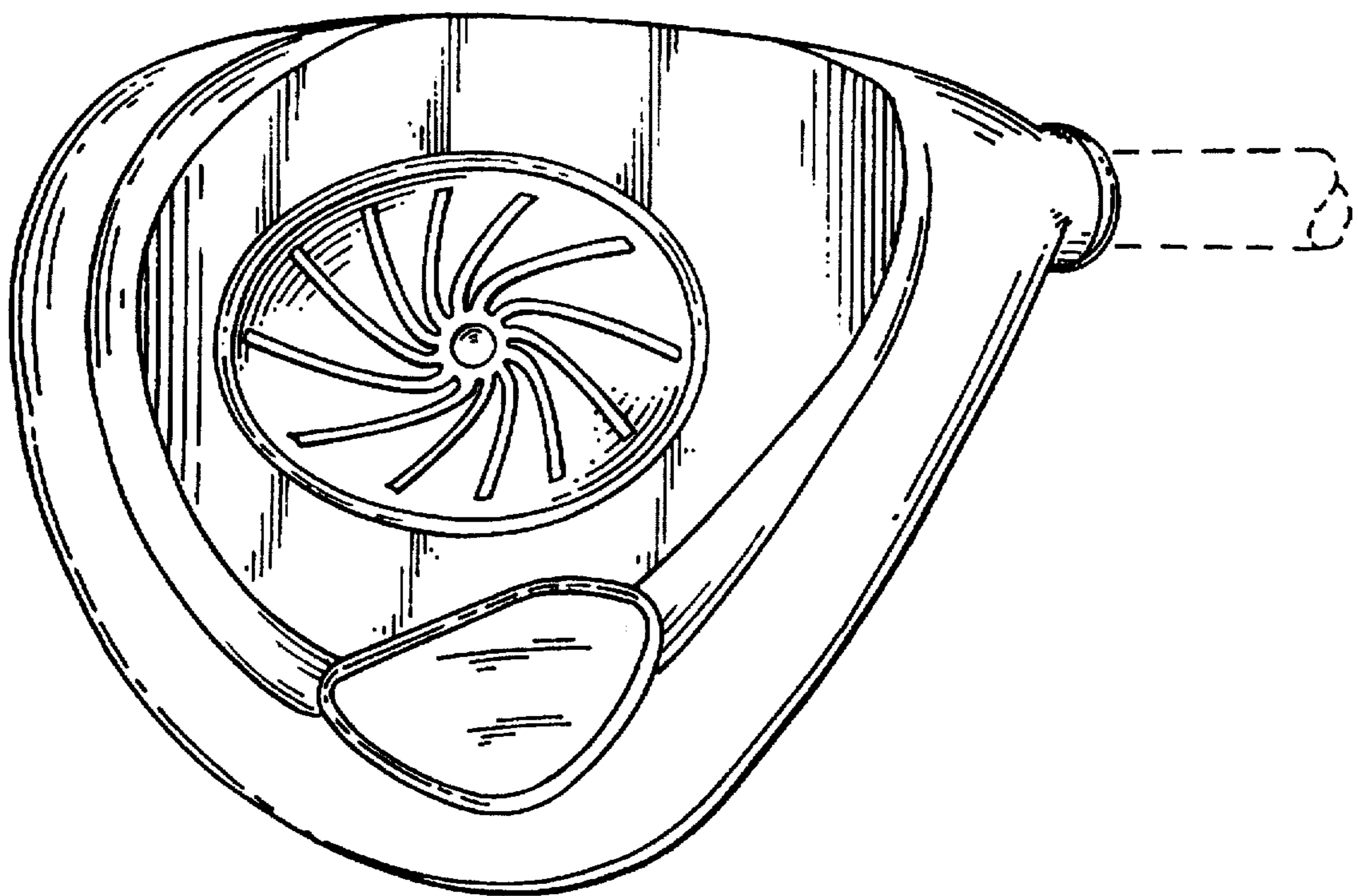

FIG. 7

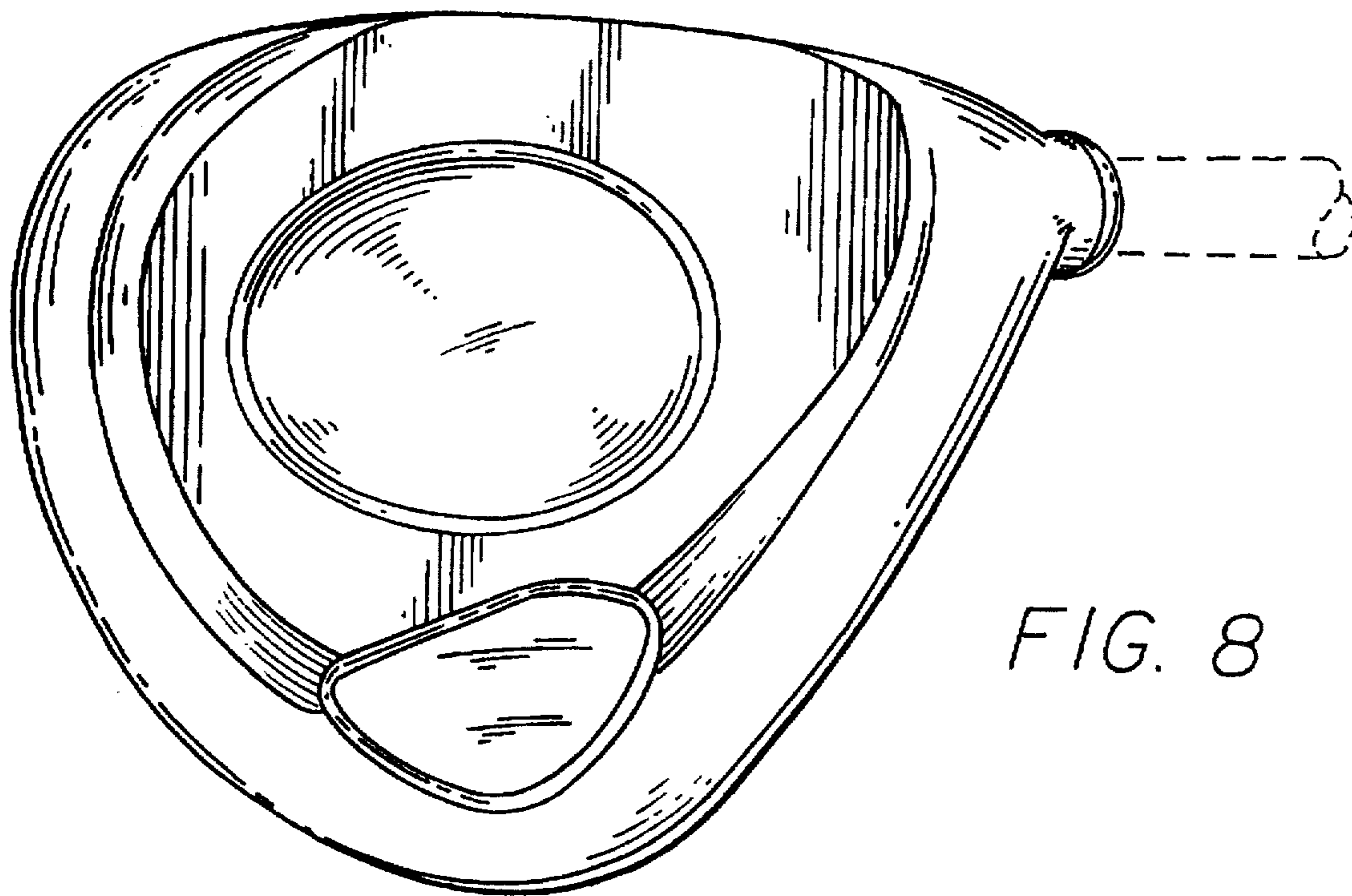

FIG. 8

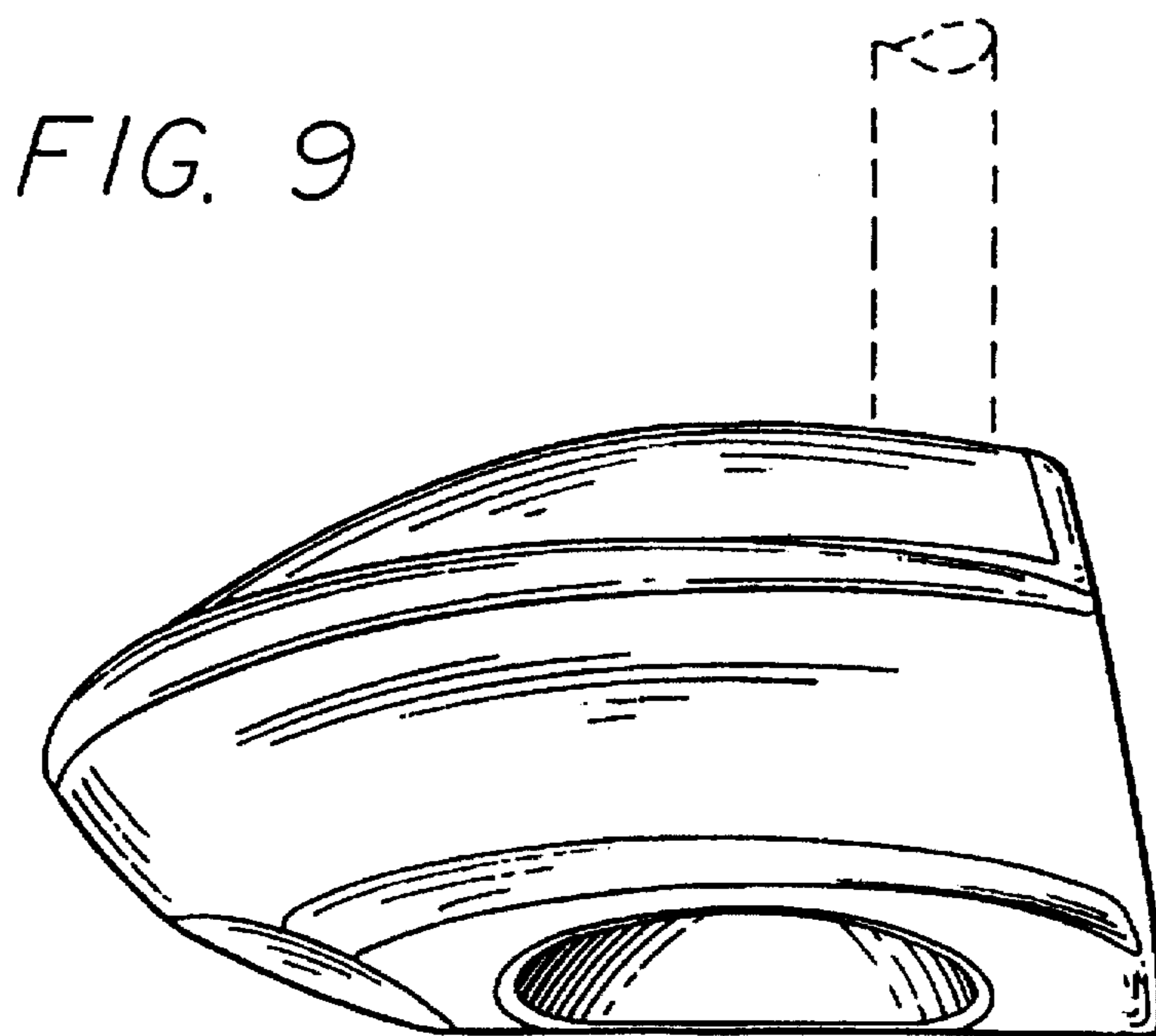

FIG. 9