



US00D390282S

United States Patent [19]
Burdick

[11] **Patent Number:** **Des. 390,282**
[45] **Date of Patent:** ****Feb. 3, 1998**

[54] **LIGHTED THROWING DISC**

[75] **Inventor:** **Brett Burdick**, Knoxville, Tenn.

[73] **Assignee:** **Fi-Shock, Inc.**, Knoxville, Tenn.

[**] **Term:** **14 Years**

[21] **Appl. No.:** **58,689**

[22] **Filed:** **Aug. 20, 1996**

[51] **LOC (6) Cl.** **21-01**

[52] **U.S. Cl.** **D21/86; D21/82**

[58] **Field of Search** **D21/59, 82, 86;**
446/46, 47; 273/424; 474/570, 588

[56] **References Cited**

U.S. PATENT DOCUMENTS

D. 183,626	9/1958	Morrison	D21/86
D. 272,751	2/1984	Brackman	D21/86
D. 312,103	11/1990	Lenox	D21/86
D. 337,134	7/1993	Scruggs et al.	D21/82 X

3,359,678	12/1967	Headrick	446/46
4,435,917	3/1984	Lee	446/47
4,607,850	8/1986	O'Riley	473/588 X
4,778,428	10/1988	Wield	446/47
5,319,531	6/1994	Kutnyak	473/588 X

Primary Examiner—Dominic Simone
Attorney, Agent, or Firm—Luedeka, Neely & Graham, P.C.

[57] **CLAIM**

The ornamental design of a lighted throwing disc, as shown.

DESCRIPTION

FIG. 1 is a top perspective view;
FIG. 2 is a bottom perspective view, from a first viewpoint;
FIG. 3 is a bottom perspective view, from a second viewpoint;
FIG. 4 is a side elevation view;
FIG. 5 is a top plan view; and,
FIG. 6 is a bottom plan view.

1 Claim, 2 Drawing Sheets

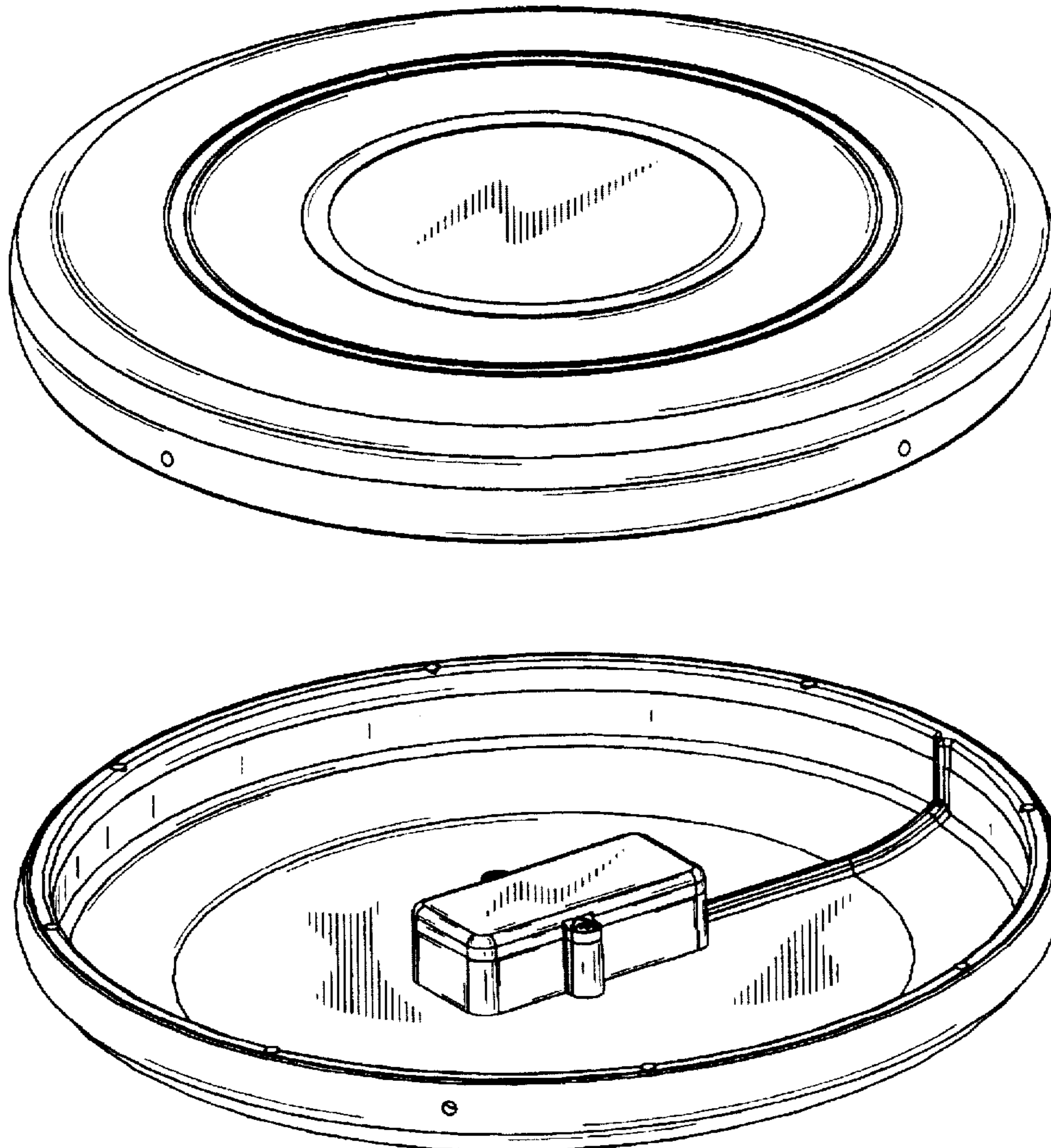

FIG. 1

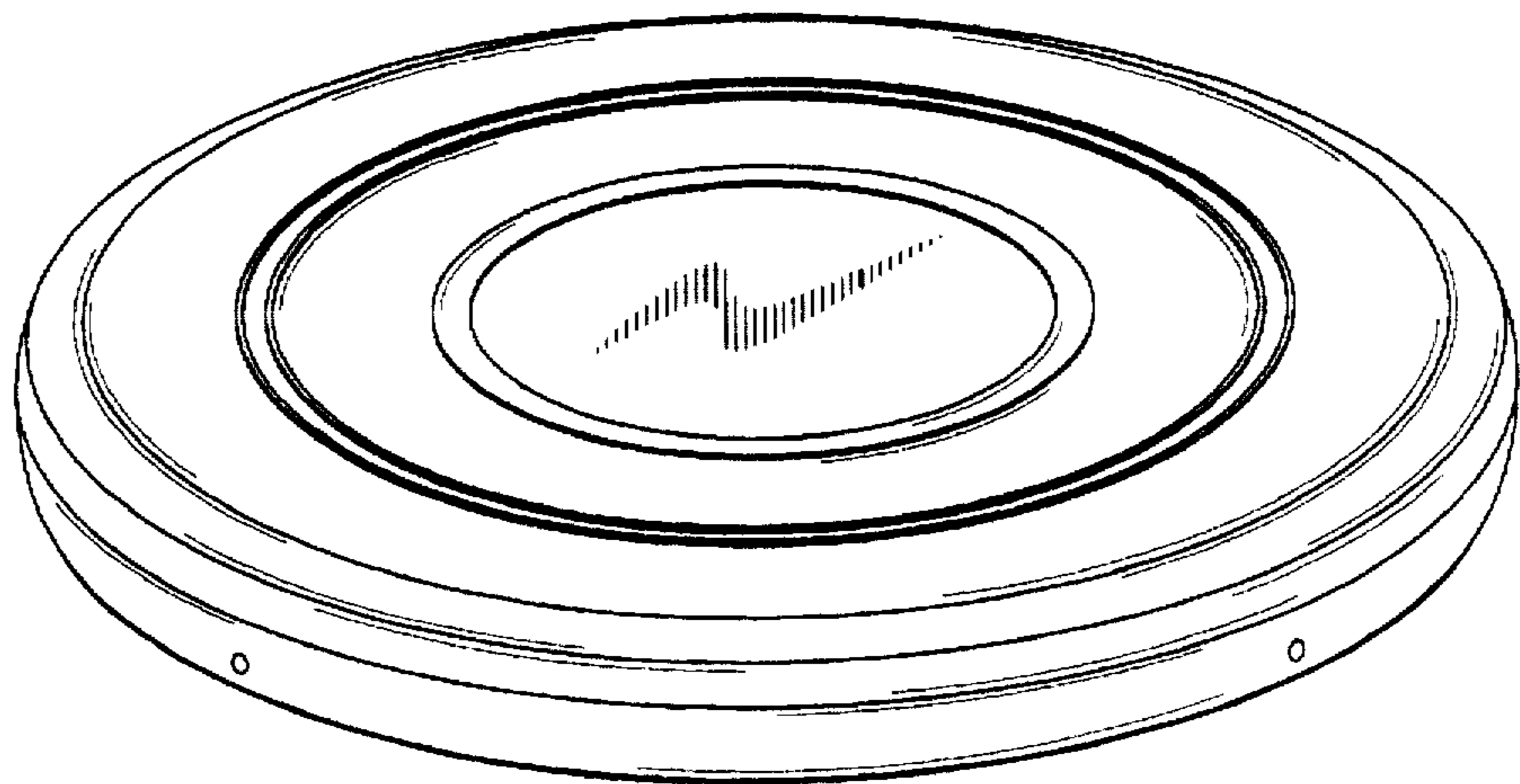

FIG. 2

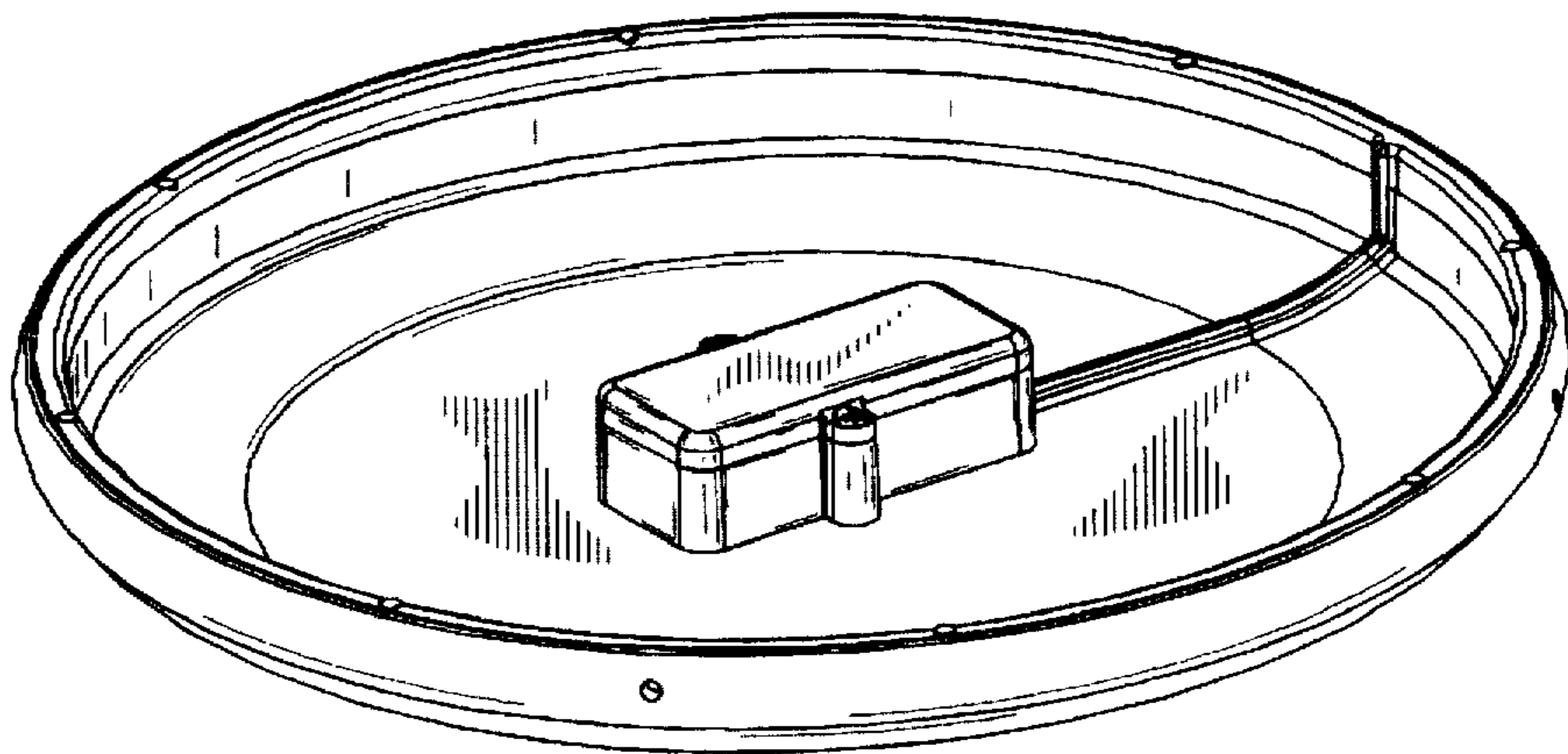

FIG. 3

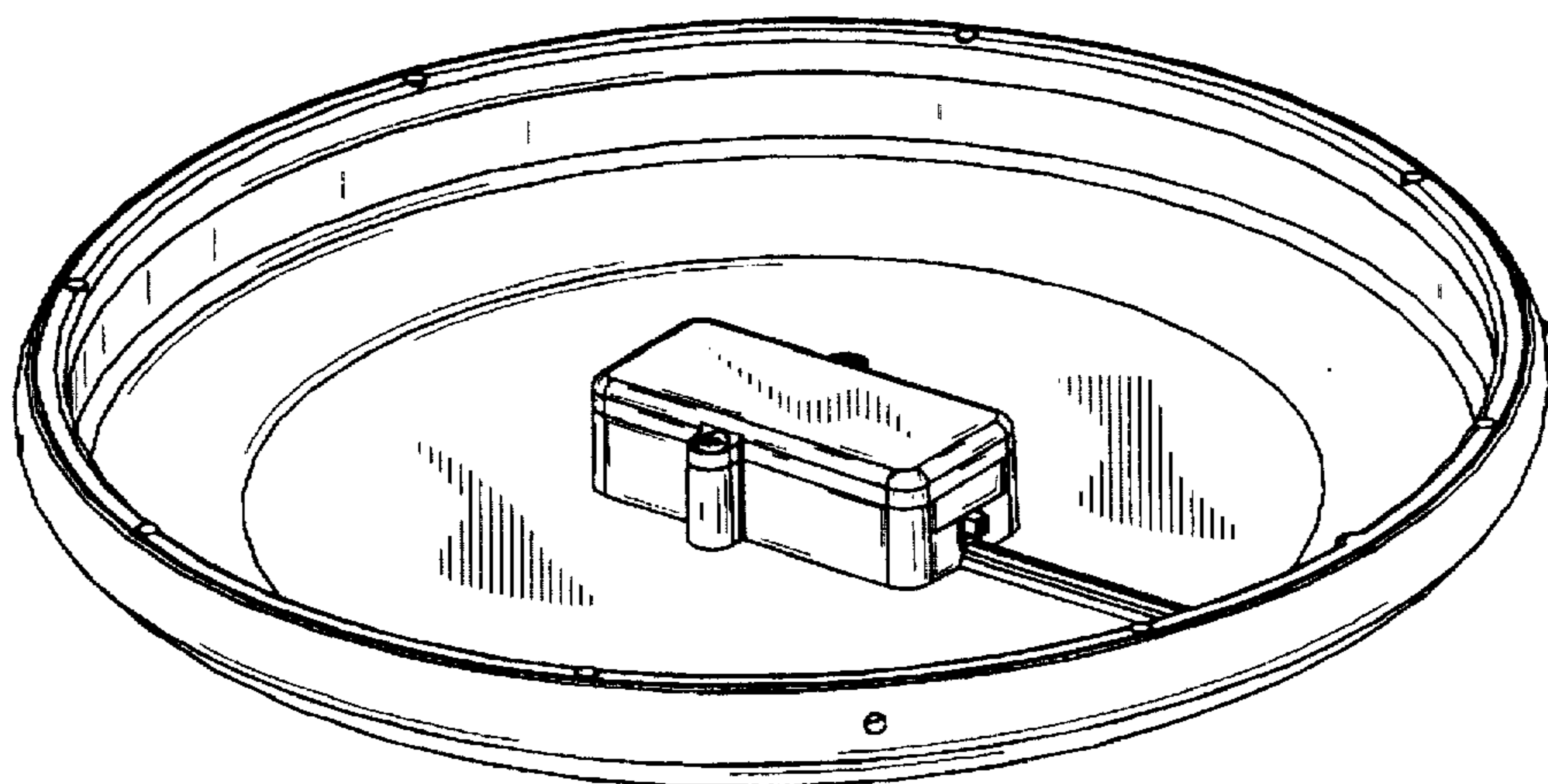
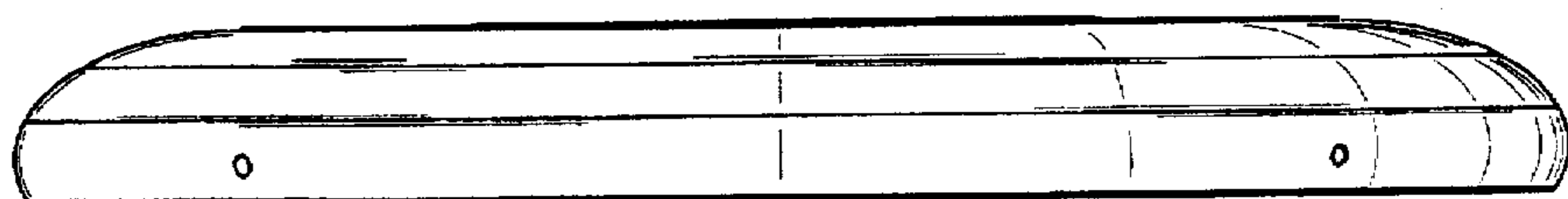

FIG. 4



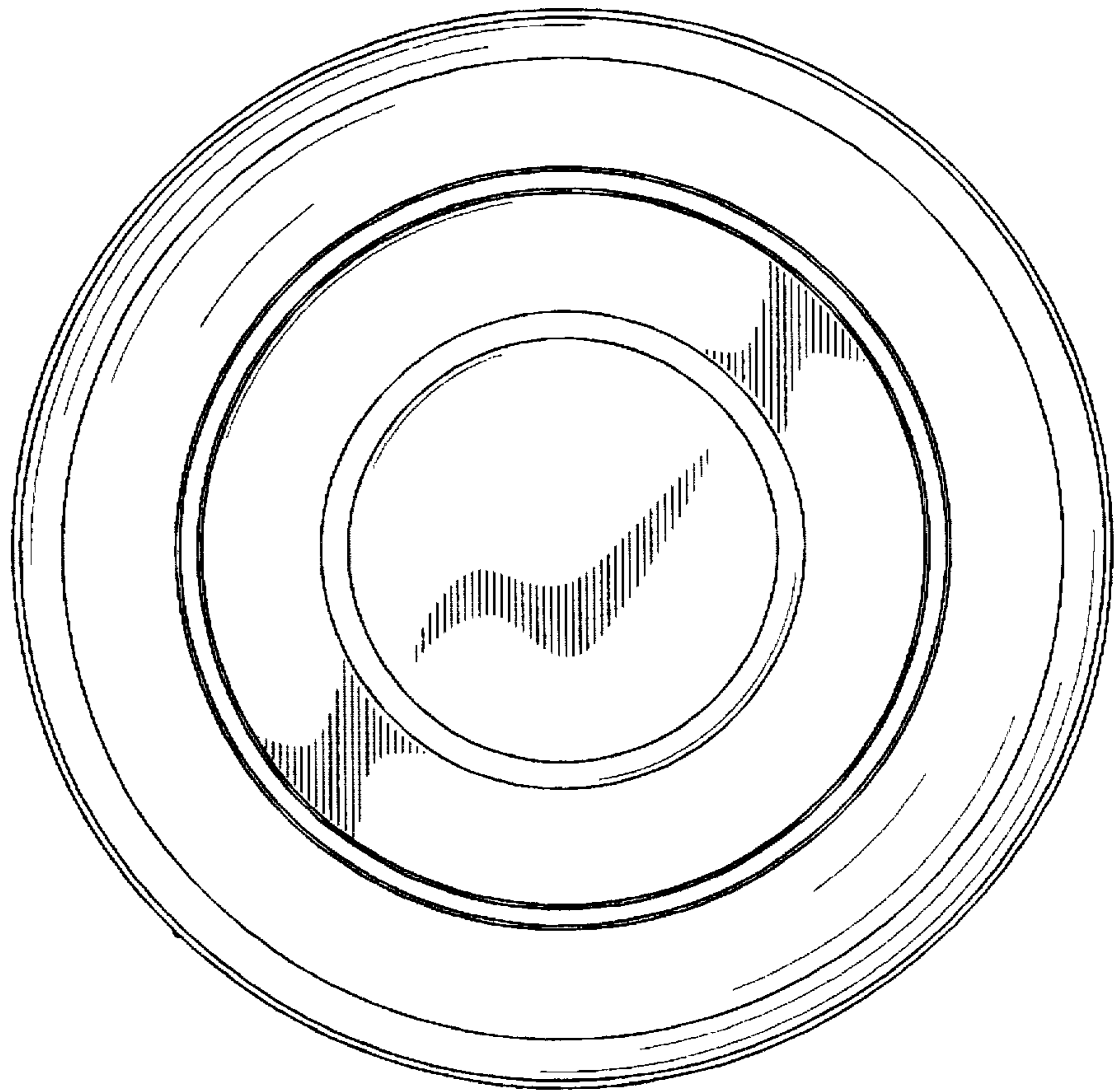

FIG. 5

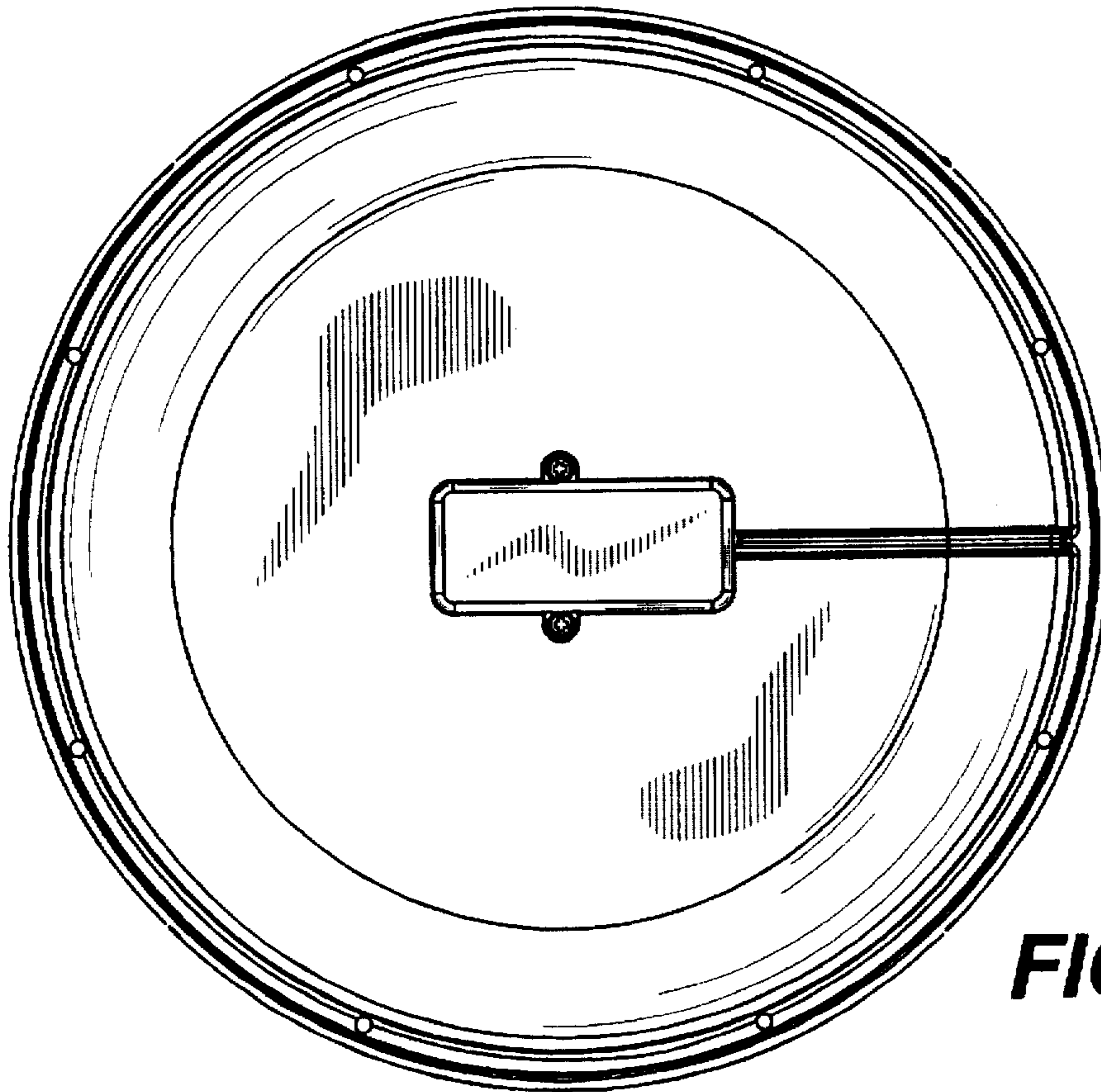

FIG. 6