



US00D390264S

United States Patent [19]

Singleton et al.

[11] Patent Number: **Des. 390,264**

[45] Date of Patent: ****Feb. 3, 1998**

[54] **BATTERY OPERATED PENCIL SHARPENER**

[75] Inventors: **Michael A. Singleton**, Warwick, R.I.;
Wells D. Haberstich, Rocky Hill,
Conn.

[73] Assignee: **Stanley - Bostitch Inc.**, East
Greenwich, R.I.

[**] Term: **14 Years**

[21] Appl. No.: **64,882**

[22] Filed: **Jan. 13, 1997**

[51] LOC (6) Cl. **19-06**

[52] U.S. Cl. **D19/73; D19/65**

[58] Field of Search **D8/98; D19/65,**
D19/73, 74, 75, 95, 99, 100, 35; 144/28.1,
28.11, 28.2-28.7, 28.72, 28.8, 28.9, 30;
30/451-462

[56] **References Cited**

U.S. PATENT DOCUMENTS

D. 251,008 2/1979 Kajiwara D19/73

D. 265,323 7/1982 Macowski D19/73
D. 298,340 11/1988 Yuen D19/73
D. 320,812 10/1991 Yuen D19/73
D. 354,987 1/1995 Yuen D19/73
2,504,194 4/1950 Harrington 30/452

Primary Examiner—Martie Thompson
Attorney, Agent, or Firm—Cushman, Darby & Cushman IP
Group of Pillsbury Madison & Sutro LLP

[57] **CLAIM**

The ornamental design for a battery operated pencil sharpener, as shown and described.

DESCRIPTION

FIG. 1 is a perspective view of a battery operated pencil sharpener showing our new design, looking at the top, from the left side;
FIG. 2 is a left side elevational view thereof, the right side thereof being a mirror image thereof;
FIG. 3 is a top plan view thereof;
FIG. 4 is a bottom plan view thereof;
FIG. 5 is a front elevational view thereof; and,
FIG. 6 is a rear elevational view thereof.

1 Claim, 3 Drawing Sheets

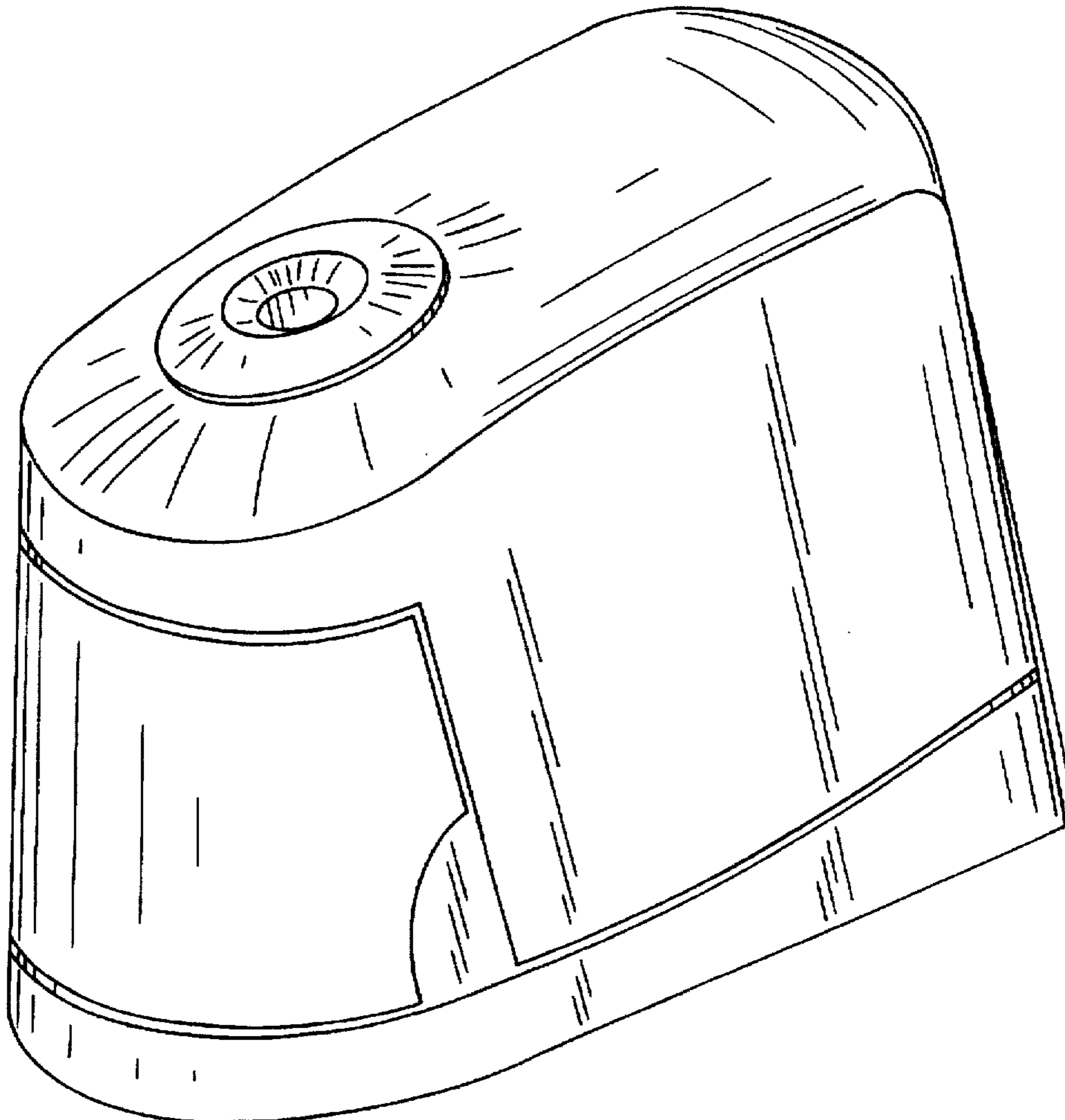

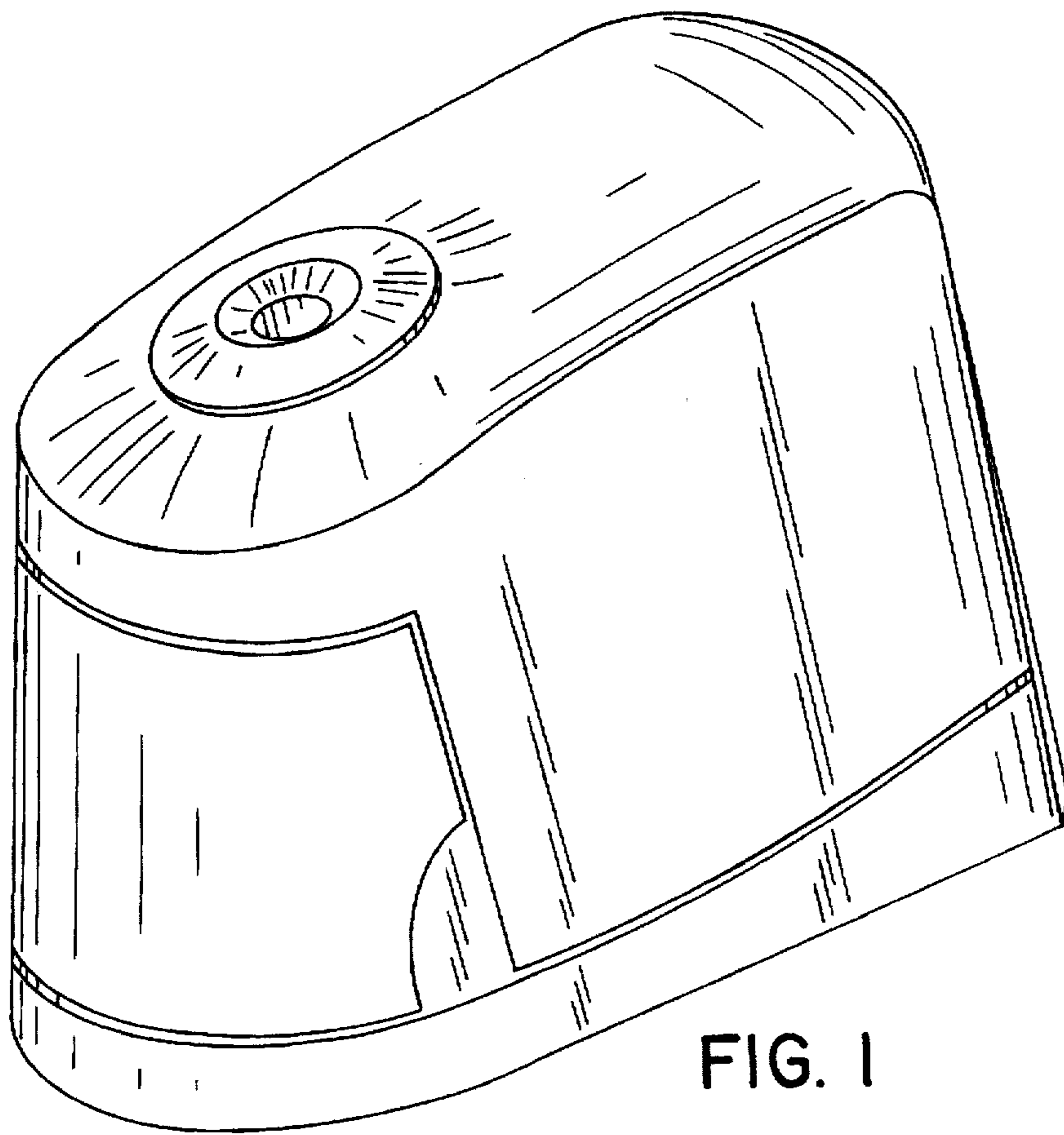

FIG. 1

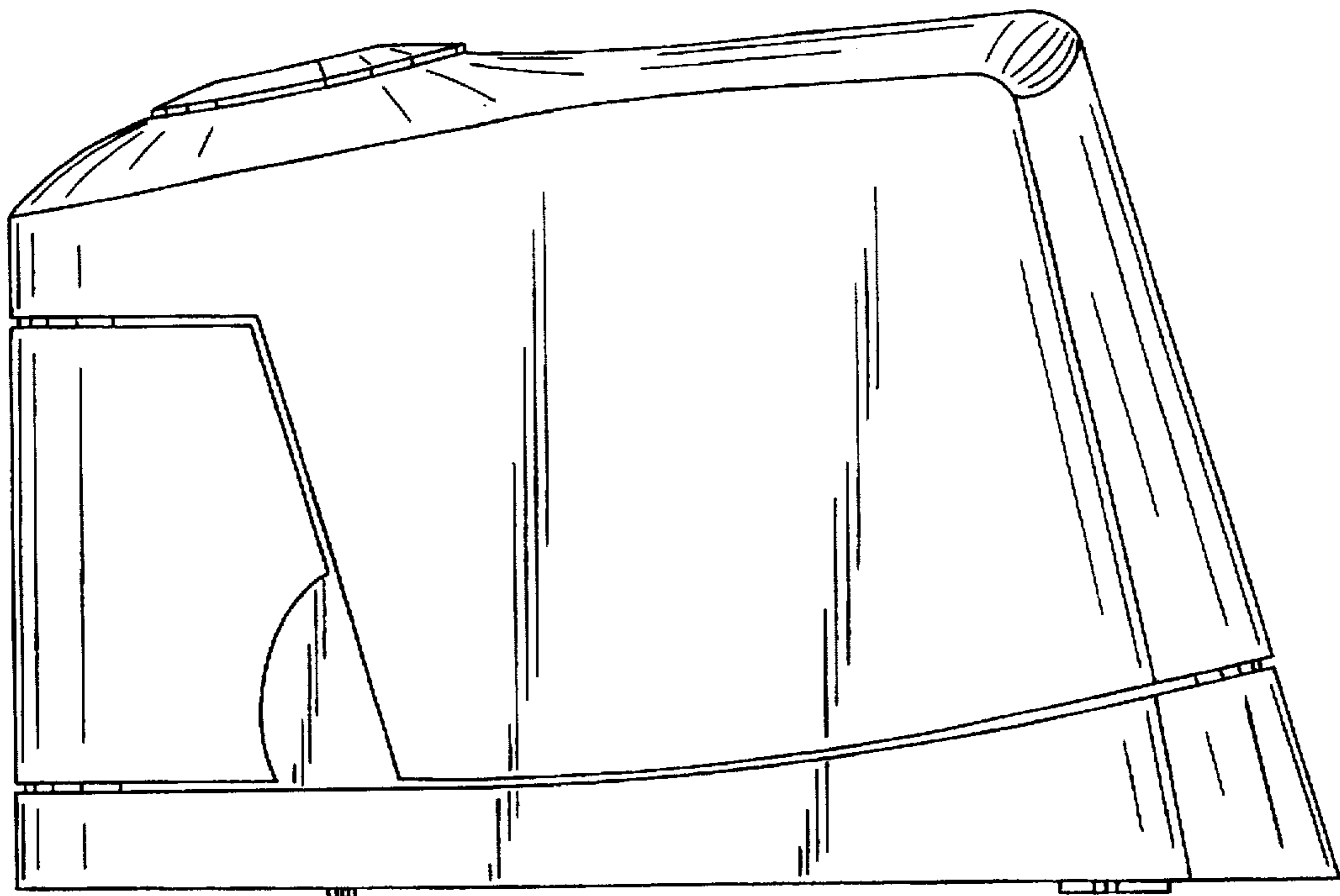

FIG. 2

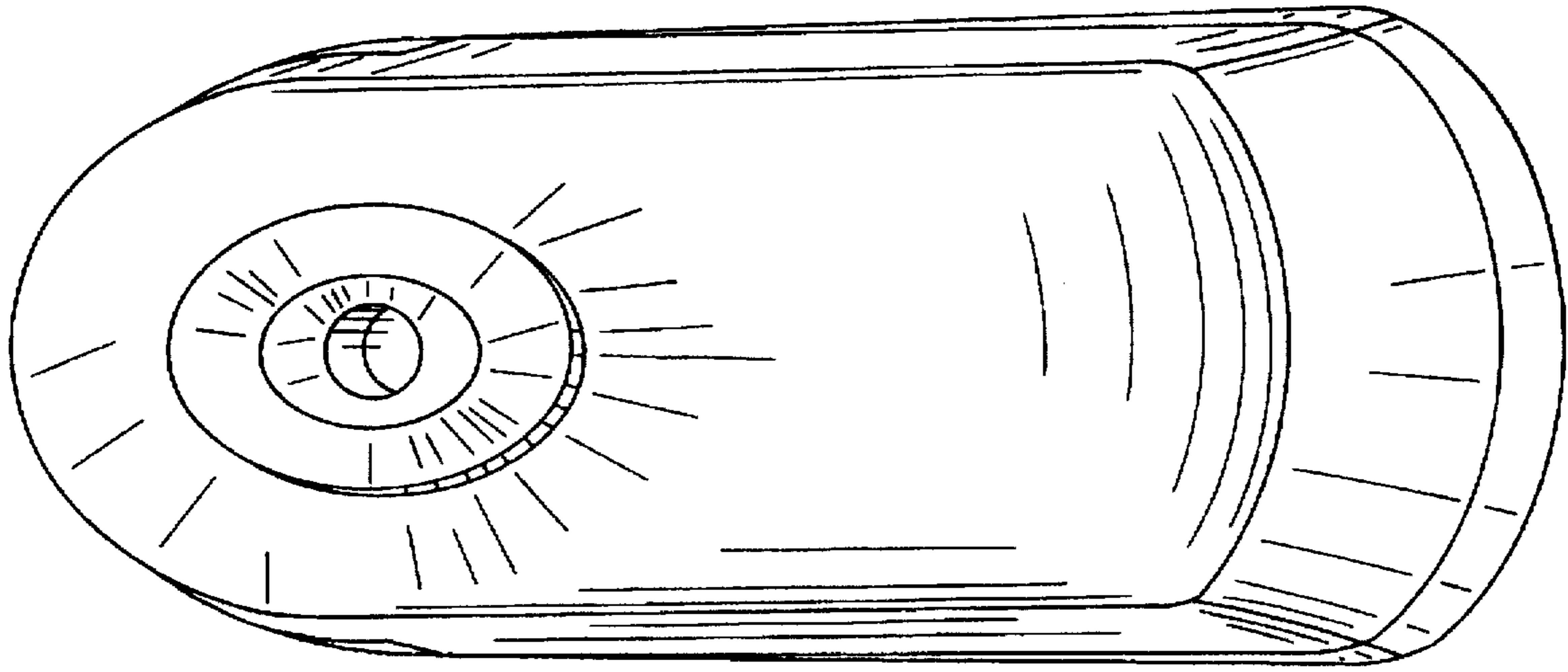

FIG. 3

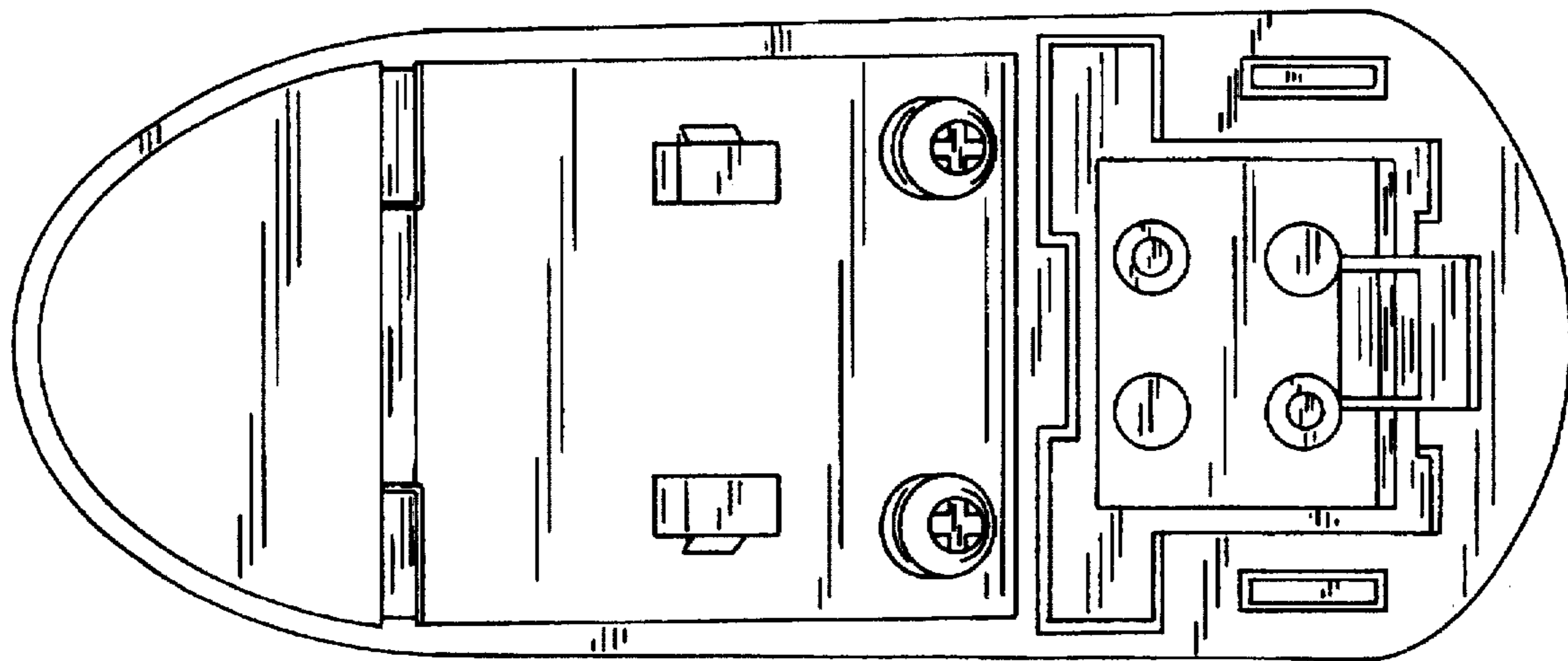

FIG. 4

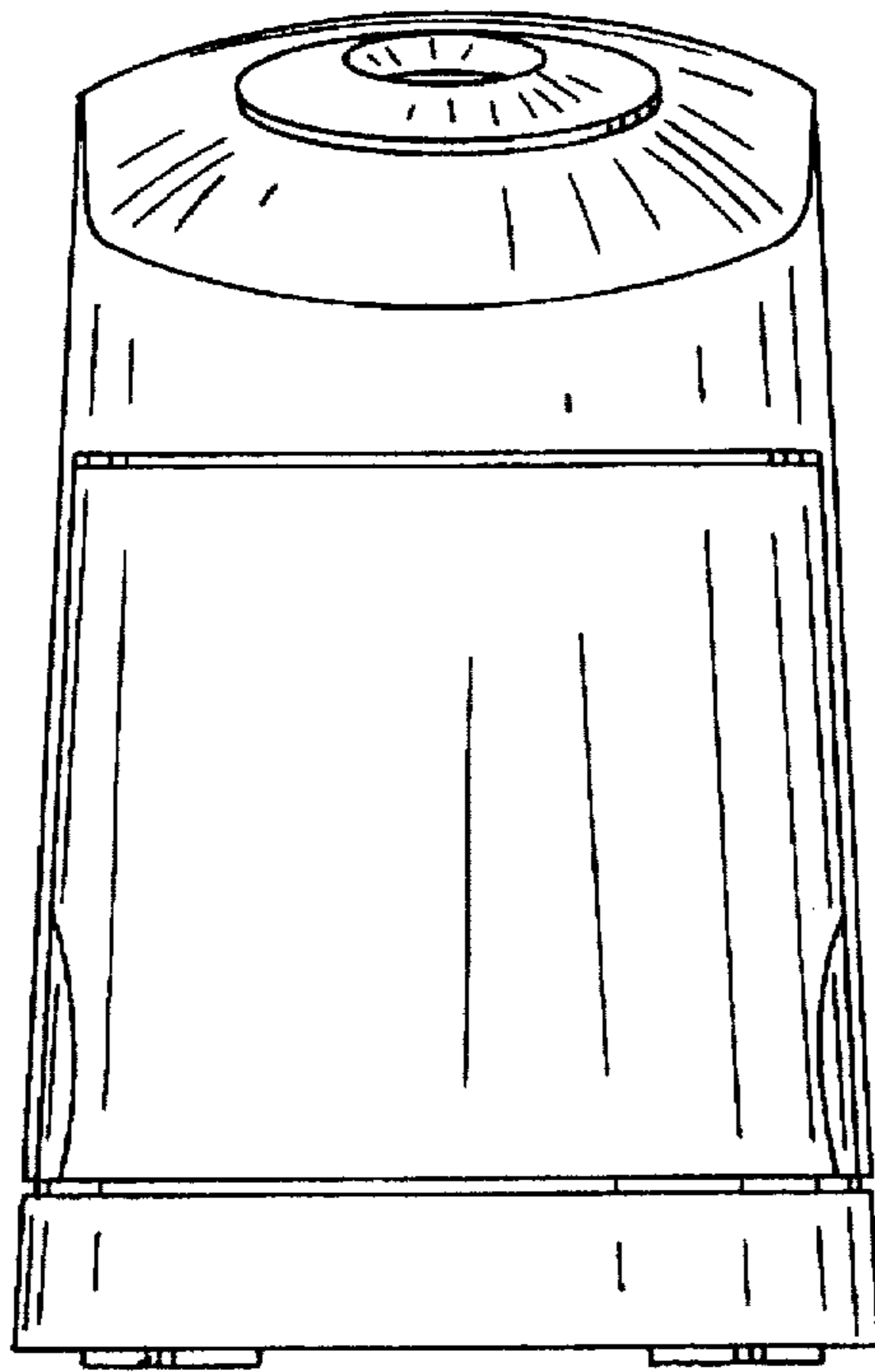

FIG. 5

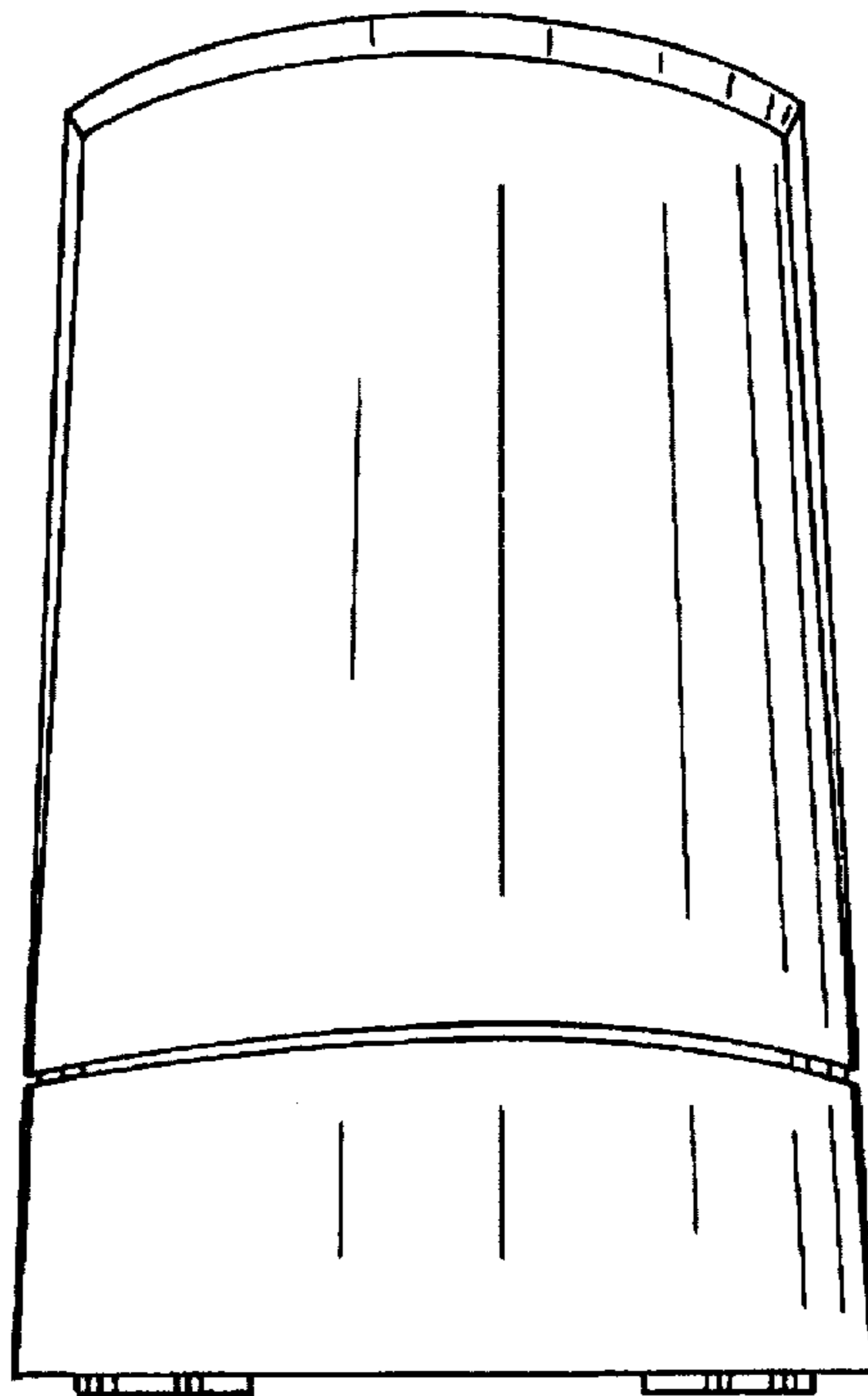

FIG. 6