



US00D390211S

United States Patent [19]

Yates et al.

[11] Patent Number: **Des. 390,211**

[45] Date of Patent: ****Feb. 3, 1998**

[54] **COMBINED COMPUTER CONTROL AND TOUCH PAD**

[75] Inventors: **William Yates**, Camarillo; **Michael R. Smither**, Castaic; **Jack Segal**, Oxnard; **James Tickle**, Thousand Oaks, all of Calif.

[73] Assignee: **Interlink Electronics, Inc.**, Camarillo, Calif.

[**] Term: **14 Years**

[21] Appl. No.: **65,545**

[22] Filed: **Mar. 19, 1997**

[51] LOC (6) Cl. **14-02**

[52] U.S. Cl. **D14/114; D14/115; D14/106**

[58] Field of Search **D14/100, 101, D14/106, 113, 114, 115; D21/48; 345/156-167; 200/5 A, 5 R, 6 A, 6 R; 273/148 B; 74/471**

[56] **References Cited**

U.S. PATENT DOCUMENTS

- D. 359,036 6/1995 Mandel D14/114
- D. 361,553 8/1995 DeFulius D14/106
- D. 375,492 11/1996 Chung D14/115

- D. 376,356 12/1996 Chung D14/115
- 5,452,960 9/1995 Kuhlenschmidt D14/115

Primary Examiner—Kay H. Chin
Attorney, Agent, or Firm—Brooks & Kushman P.C.

[57] **CLAIM**

The ornamental design for a combined computer control and touch pad, as shown and described.

DESCRIPTION

FIG. 1 is a perspective view of a touch pad of the computer control showing our new design;
 FIG. 2 is a top plan view of a FIG. 1;
 FIG. 3 is a front elevational view of FIG. 1;
 FIG. 4 is a right side elevational view of FIG. 1;
 FIG. 5 is a perspective view of the touch pad showing the pad in the different configuration of the computer control, the broken line illustration of the computer control is for illustrative purposes only and forms no part of the claimed design;
 FIG. 6 is a top plan view of a combined computer control and touch pad;
 FIG. 7 is a front elevational view of FIG. 6;
 FIG. 8 is a rear elevational view of FIG. 6;
 FIG. 9 is a bottom plan view of FIG. 6; and,
 FIG. 10 is a right side elevational view of FIG. 6.

1 Claim, 4 Drawing Sheets

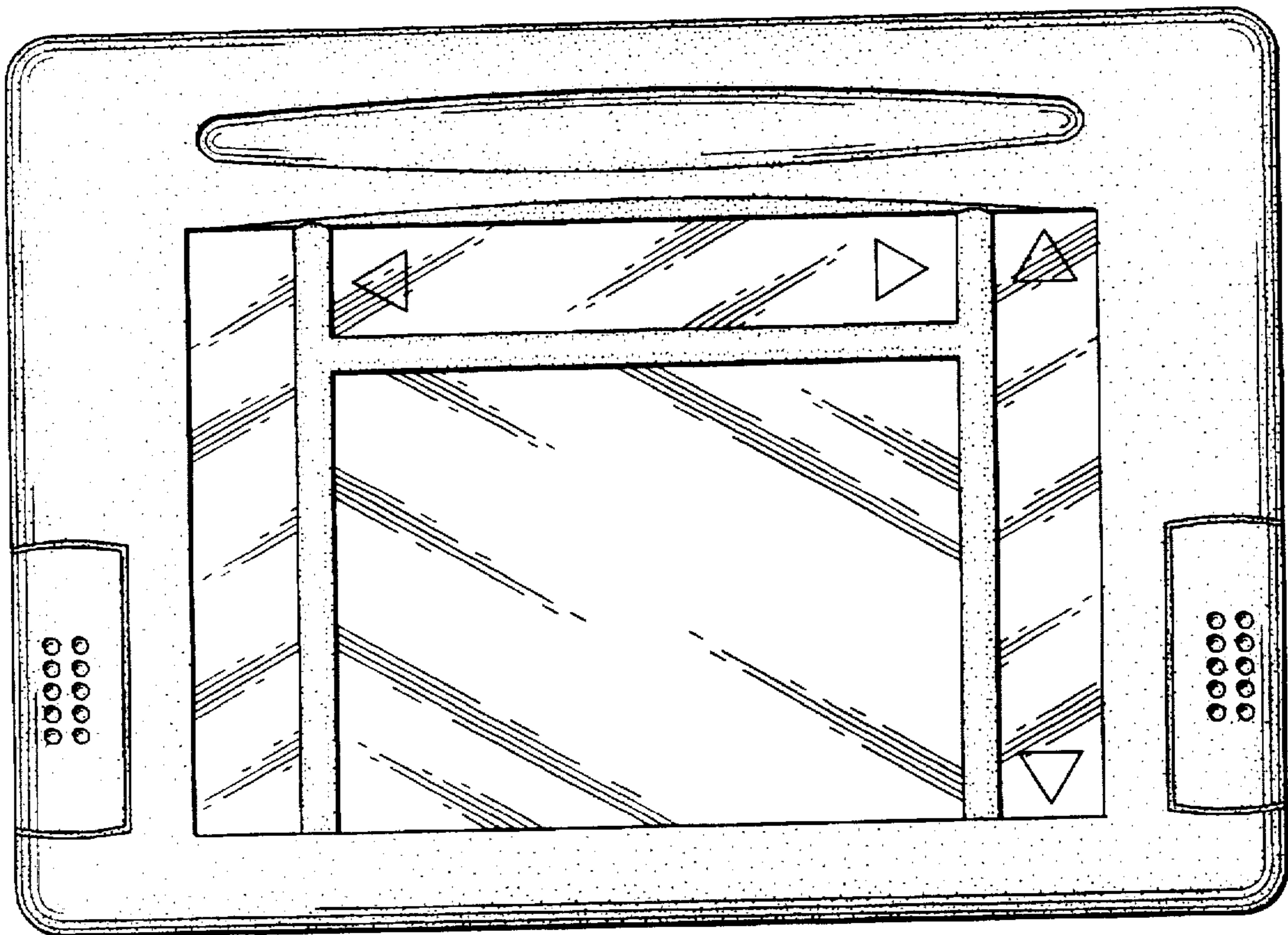

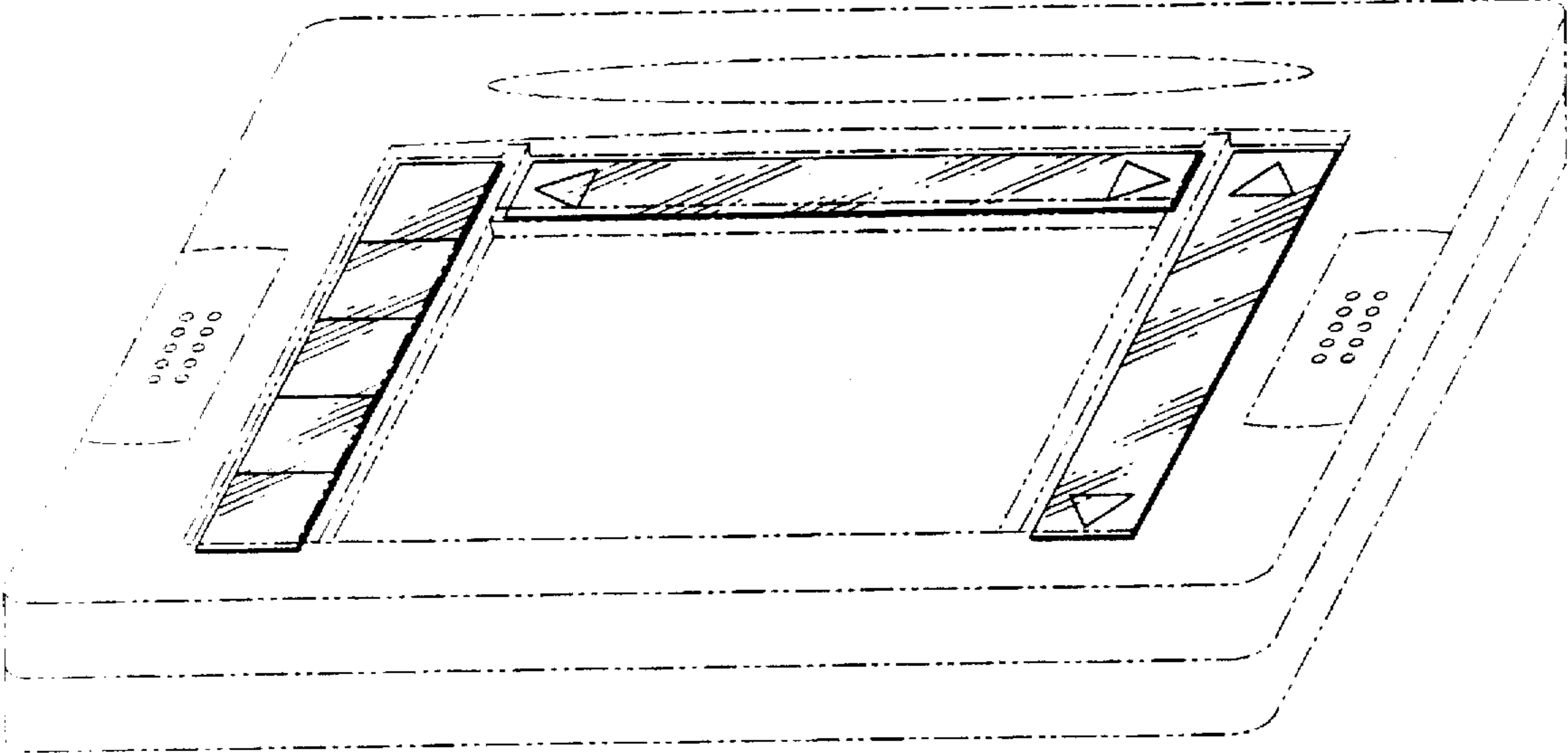

Fig. 1

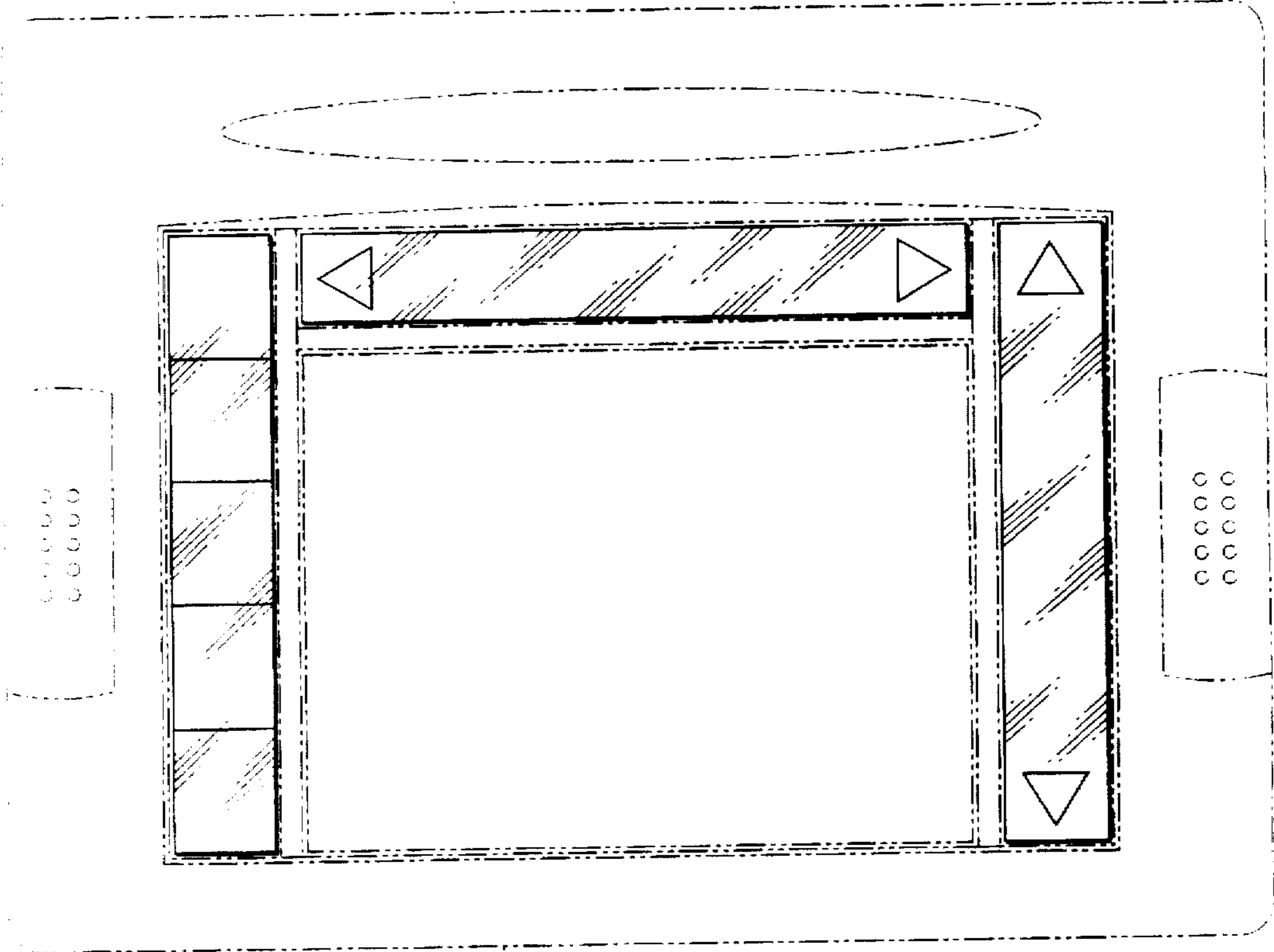

Fig. 2

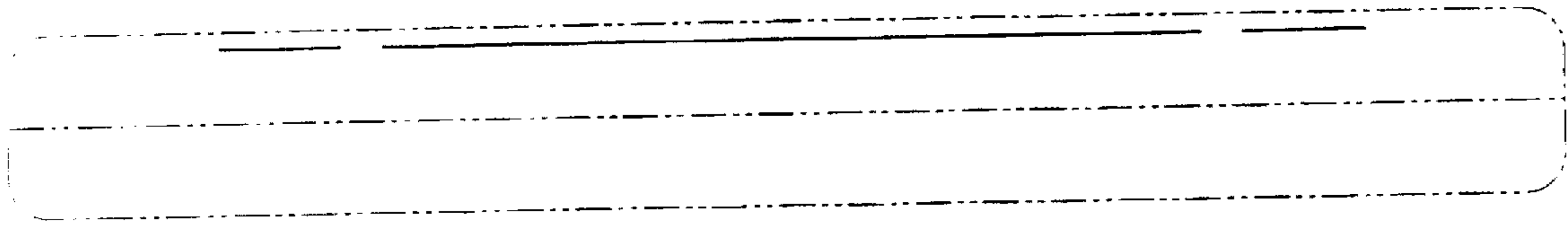

Fig. 3

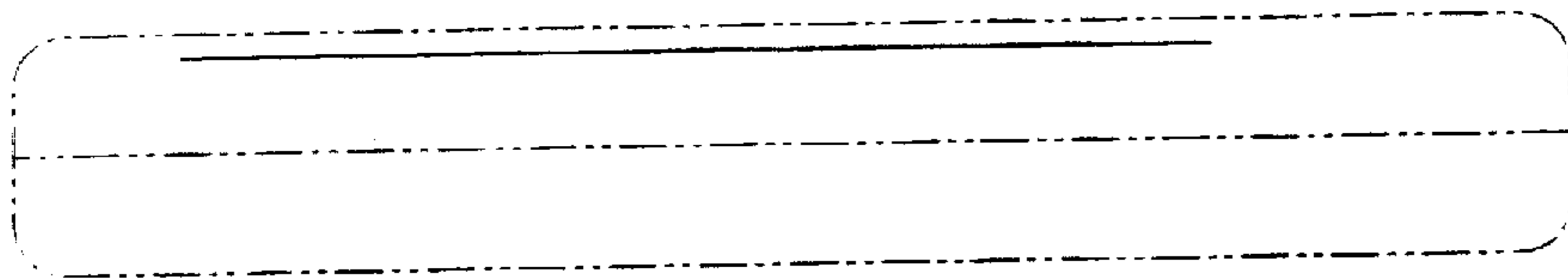

Fig. 4

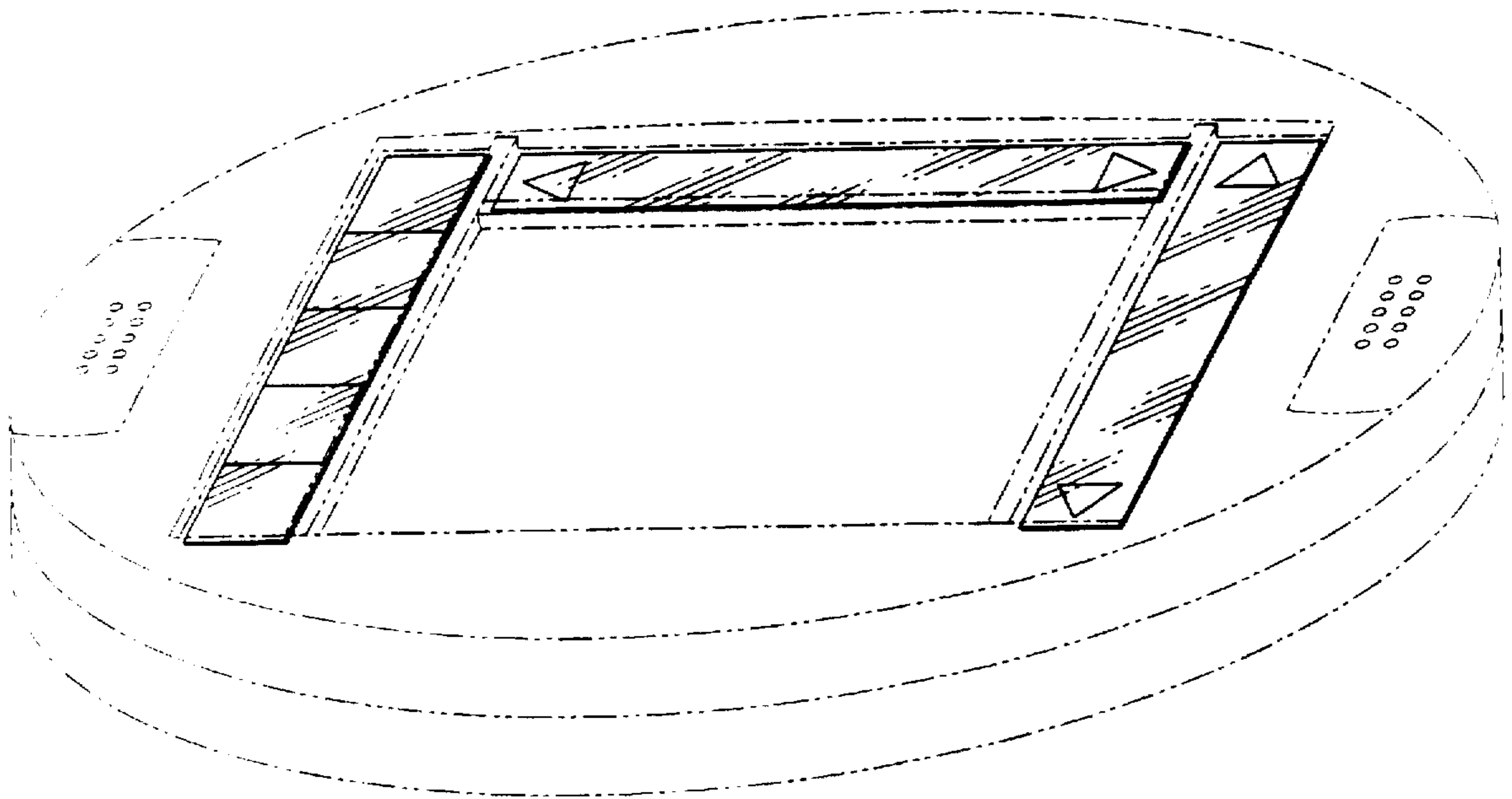

Fig. 5

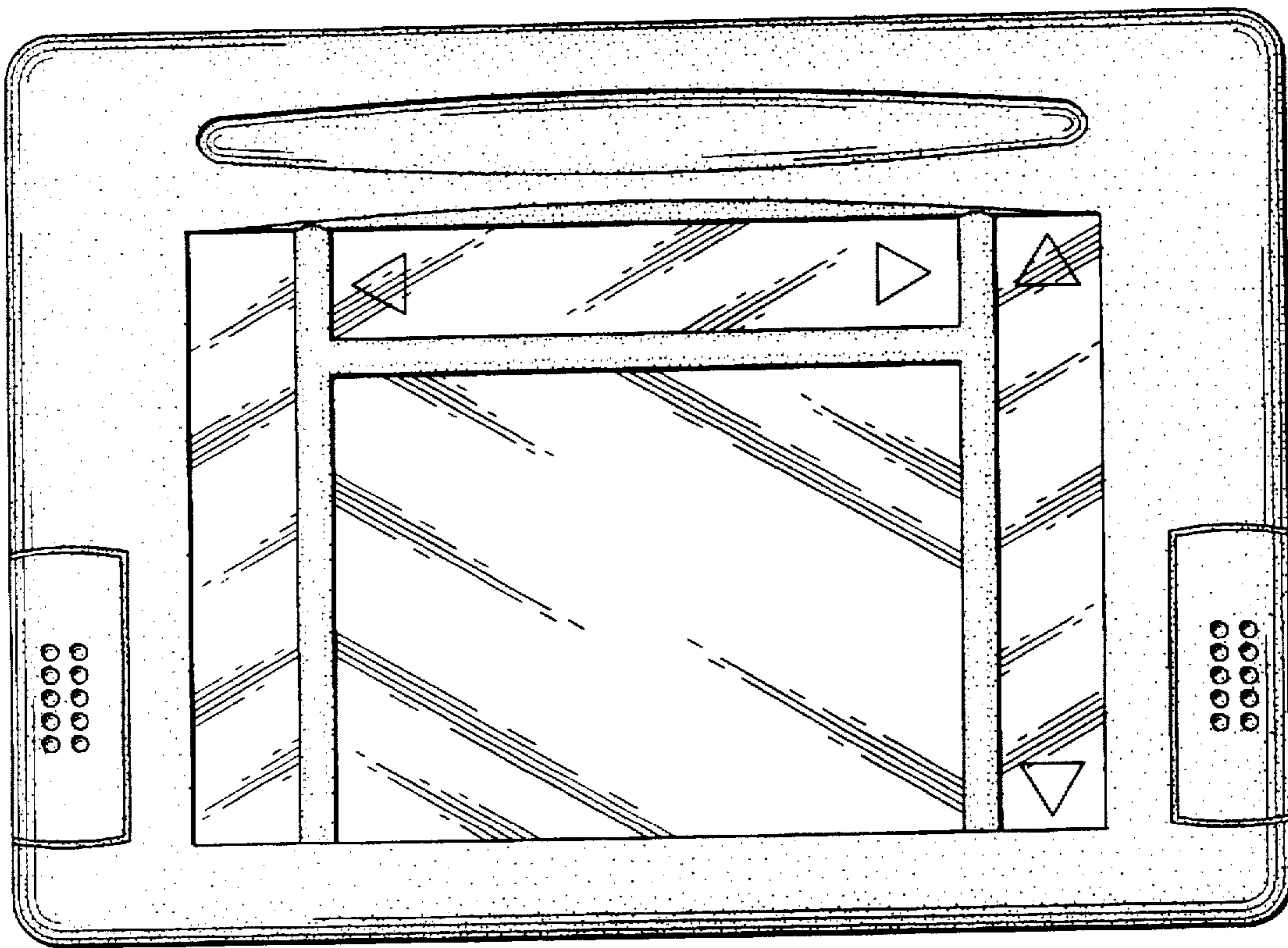

Fig. 6

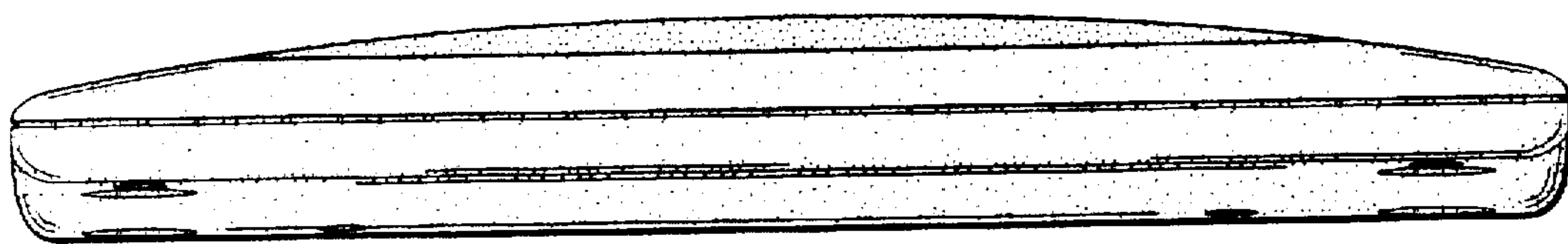

Fig. 7

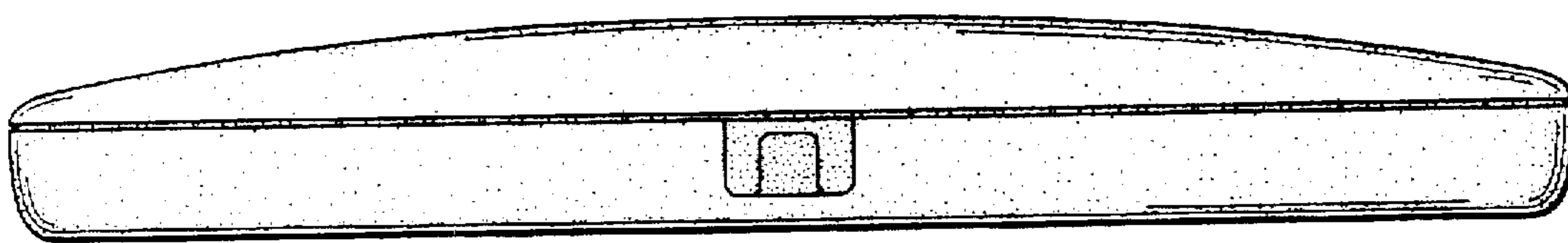

Fig. 8

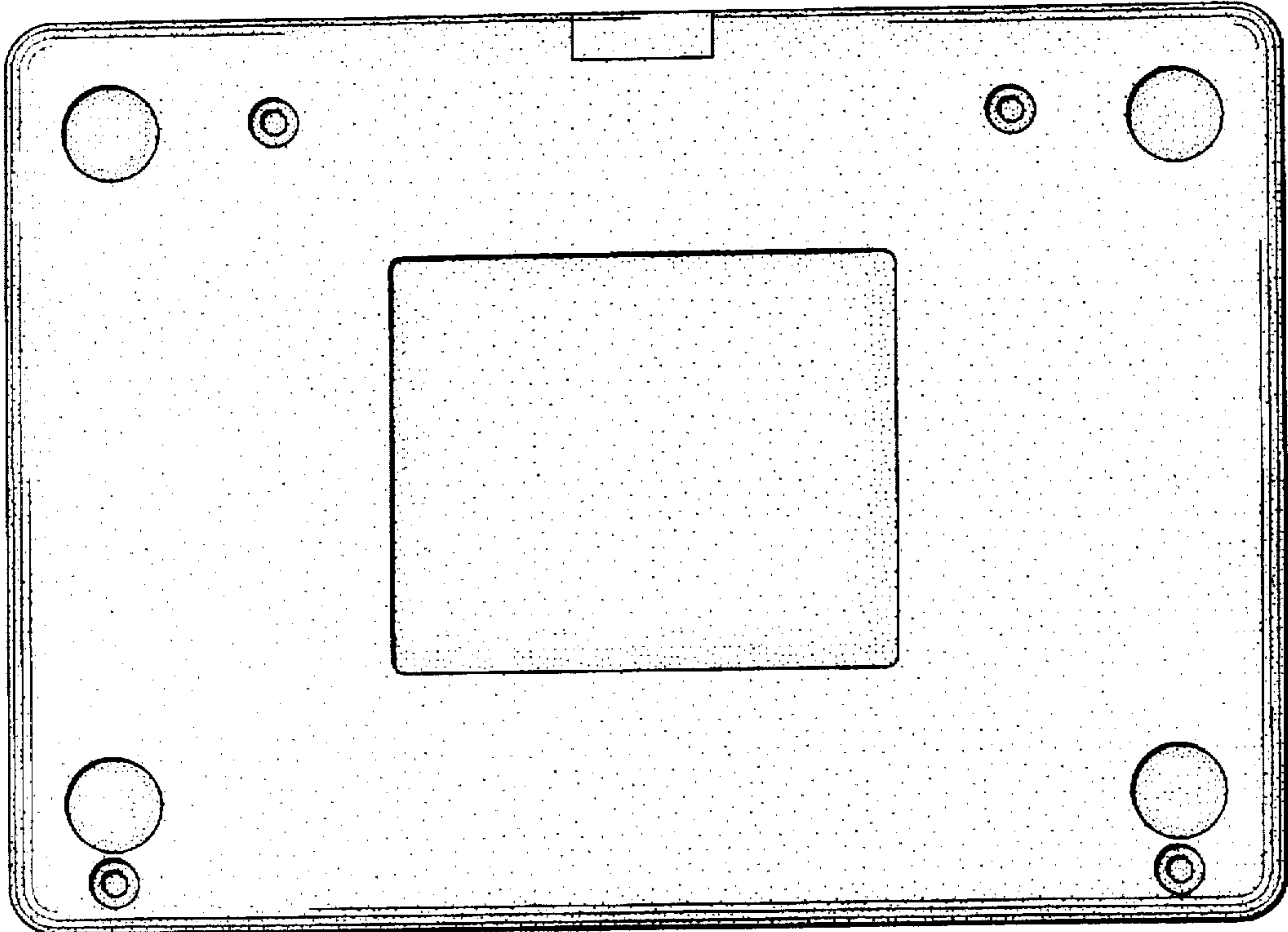

Fig. 9

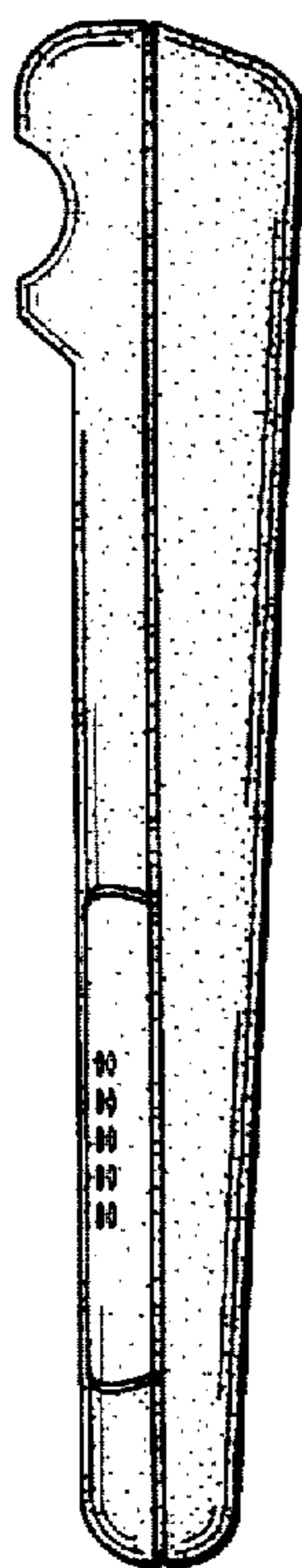

Fig. 10