

US00D390204S

**United States Patent** [19]  
**De La Fuenie Monge**

[11] **Patent Number:** **Des. 390,204**  
[45] **Date of Patent:** **\*\*Feb. 3, 1998**

[54] **CARD READER**

[75] **Inventor:** **Javier Antonio De La Fuenie Monge,**  
**Madrid, Spain**

[73] **Assignee:** **Telefonica De Espana, S.A., Madrid,**  
**Spain**

[\*\*] **Term:** **14 Years**

[21] **Appl. No.:** **63,713**

[22] **Filed:** **Dec. 13, 1996**

[30] **Foreign Application Priority Data**

Jun. 14, 1996 [ES] Spain ..... 137719

[51] **LOC (6) Cl.** ..... **14-02**

[52] **U.S. Cl.** ..... **D14/105**

[58] **Field of Search** ..... D14/100, 105,  
D14/107, 115; D18/1, 2, 7; 235/378-380,  
479, 492, 493; 361/685, 737; 341/22, 23;  
345/156, 168, 169, 172, 173

[56] **References Cited**

**U.S. PATENT DOCUMENTS**

D. 354,276 1/1995 Wilson ..... D14/105  
D. 367,472 2/1996 Clark et al. .... D14/100 X  
D. 374,661 10/1996 Mieki et al. .... D14/100

4,705,211 11/1987 Honda et al. .... 235/380  
4,812,632 3/1989 Kakinuma et al. .... 235/479  
4,968,873 11/1990 Dethloff et a. .... 235/380  
5,015,830 5/1991 Masuzawa et al. .... D14/105 X

*Primary Examiner*—Freda Nunn  
*Attorney, Agent, or Firm*—Reid & Priest L.L.P.

[57] **CLAIM**

The ornamental design for a card reader, as shown.

**DESCRIPTION**

FIG. 1 is a top perspective view of a card reader showing my new design;  
FIG. 2 is a bottom perspective view of the card reader of FIG. 1;  
FIG. 3 is a front end elevational view of the card reader of FIG. 1;  
FIG. 4 is a right side elevational view of the card reader of FIG. 1;  
FIG. 5 is a top plan view of the card reader of FIG. 1;  
FIG. 6 is a left side elevational view of the card reader of FIG. 1;  
FIG. 7 is a bottom plan view of the card reader of FIG. 1; and,  
FIG. 8 is a back end elevational view of the card reader of FIG. 1.

**1 Claim, 3 Drawing Sheets**

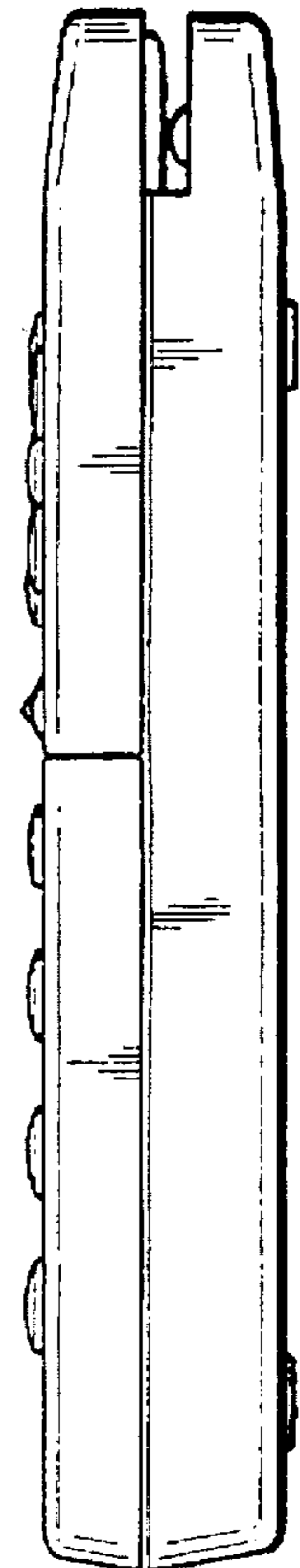
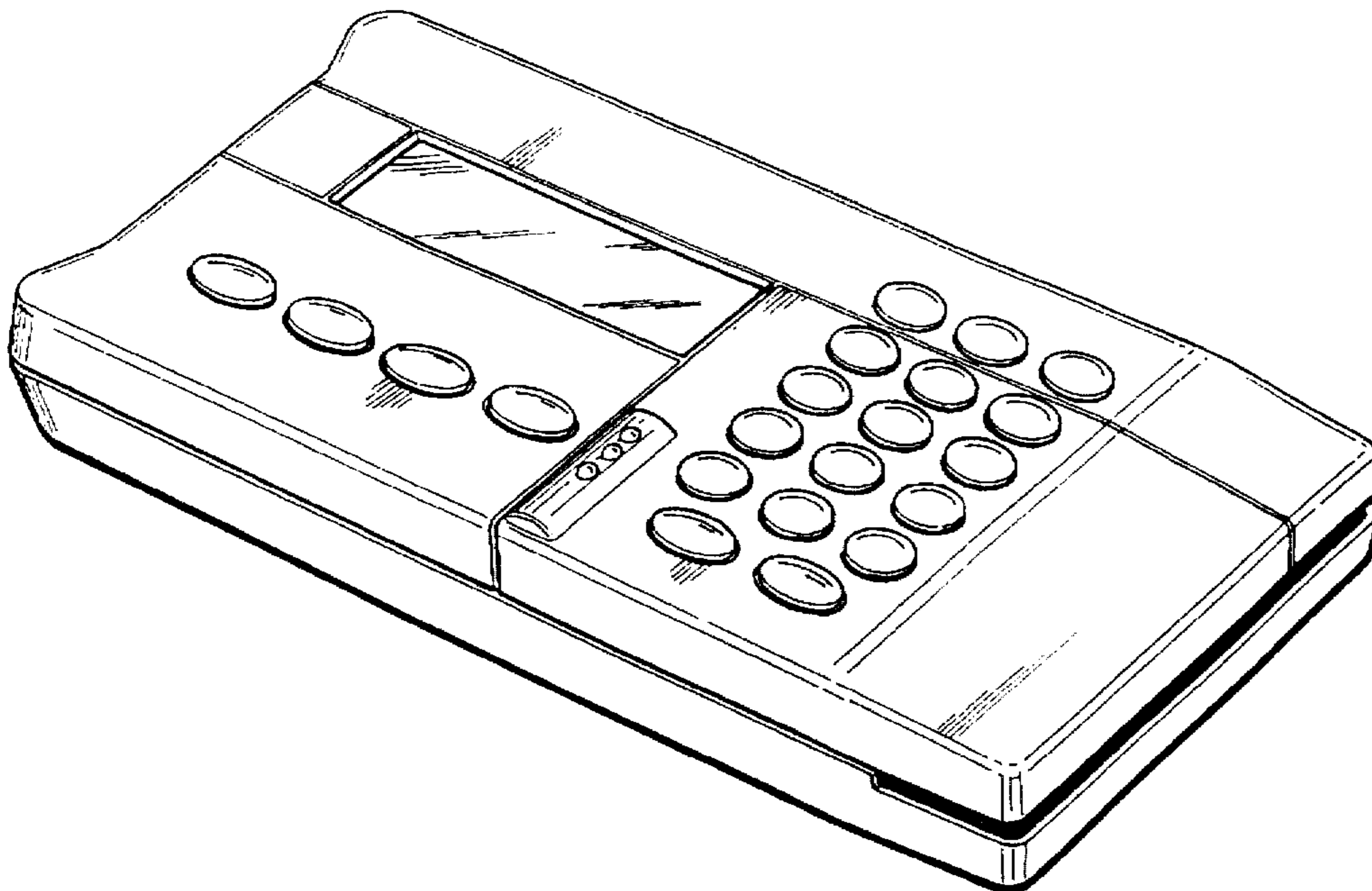

FIG.-1

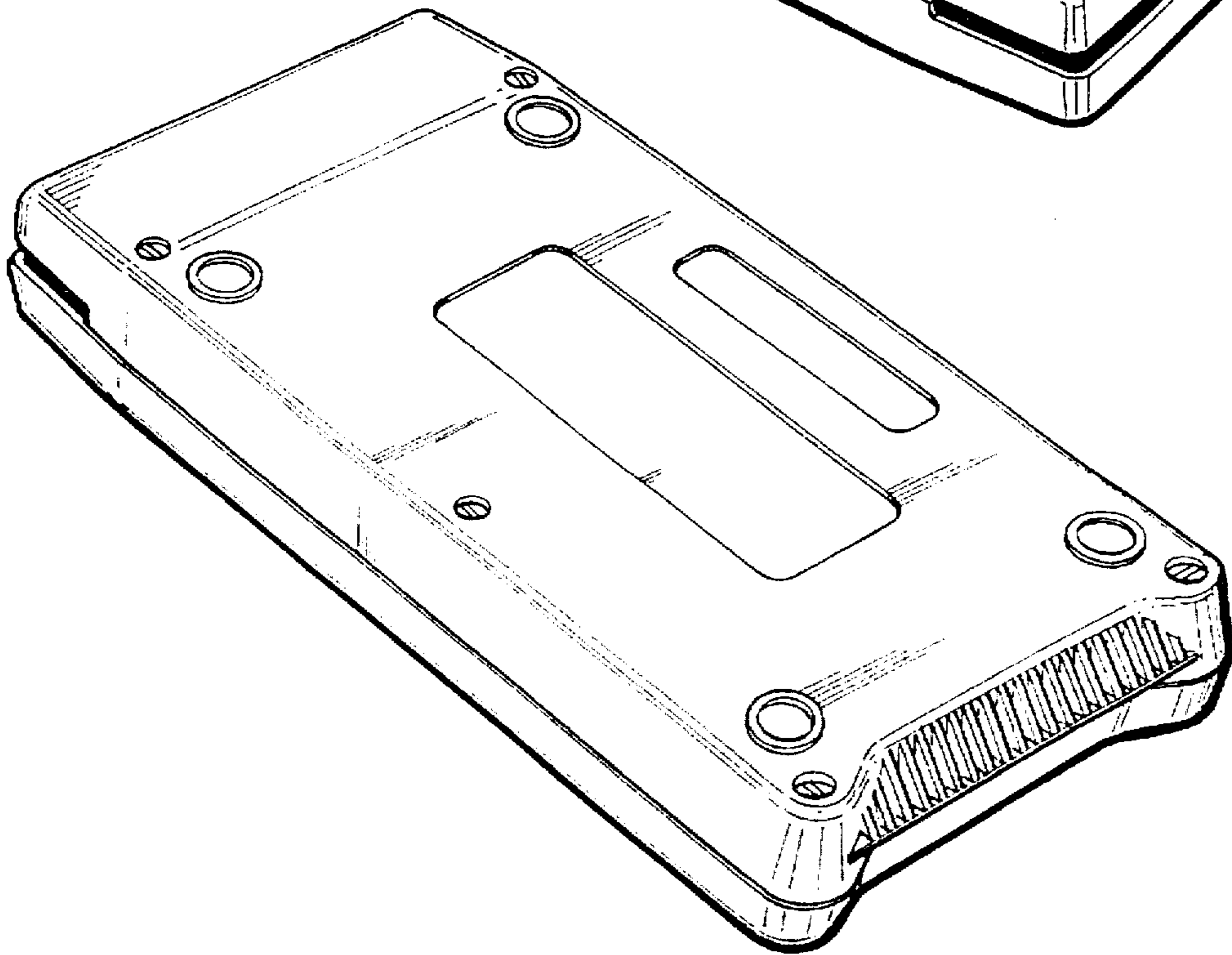
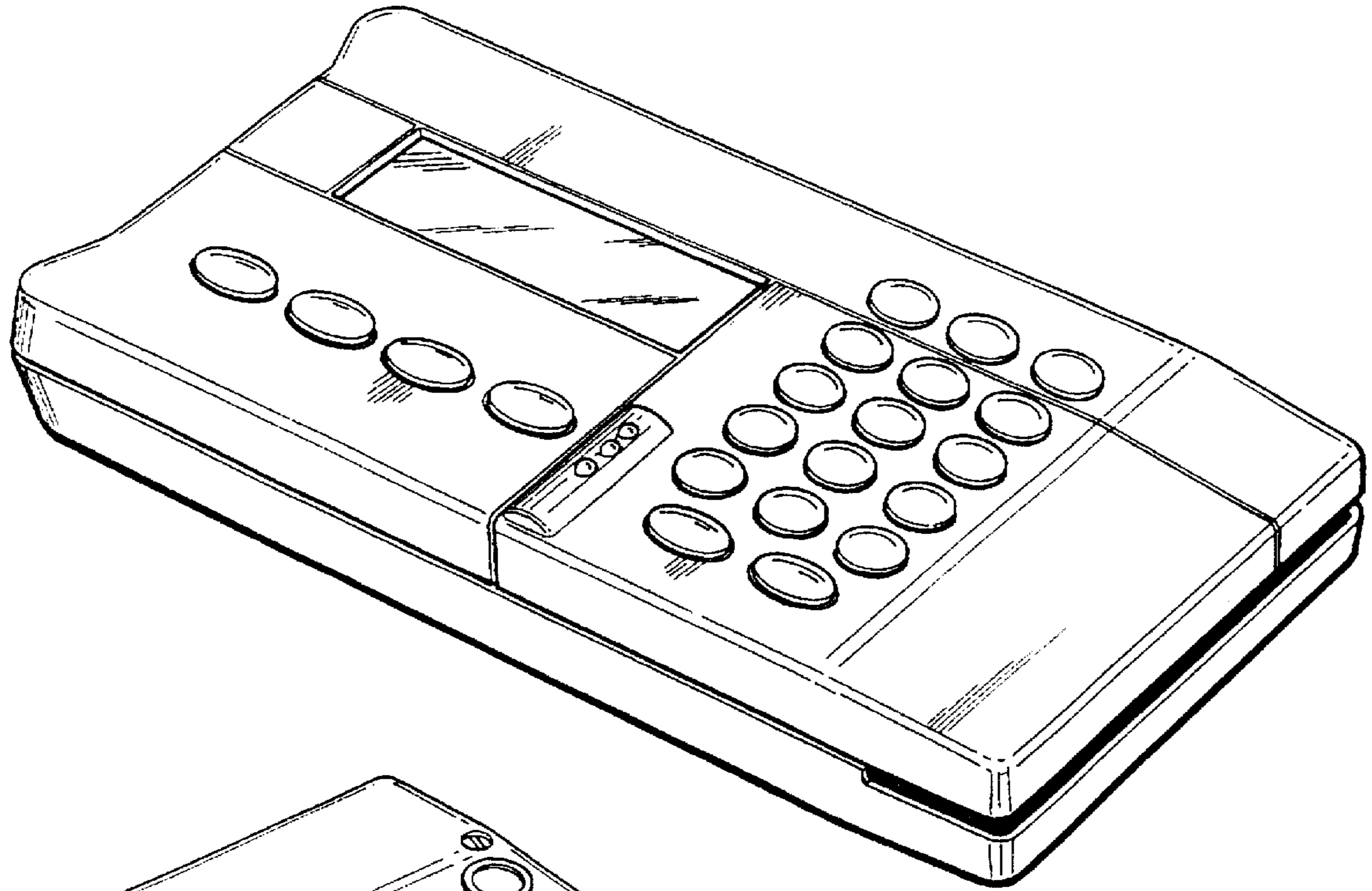

FIG.-2

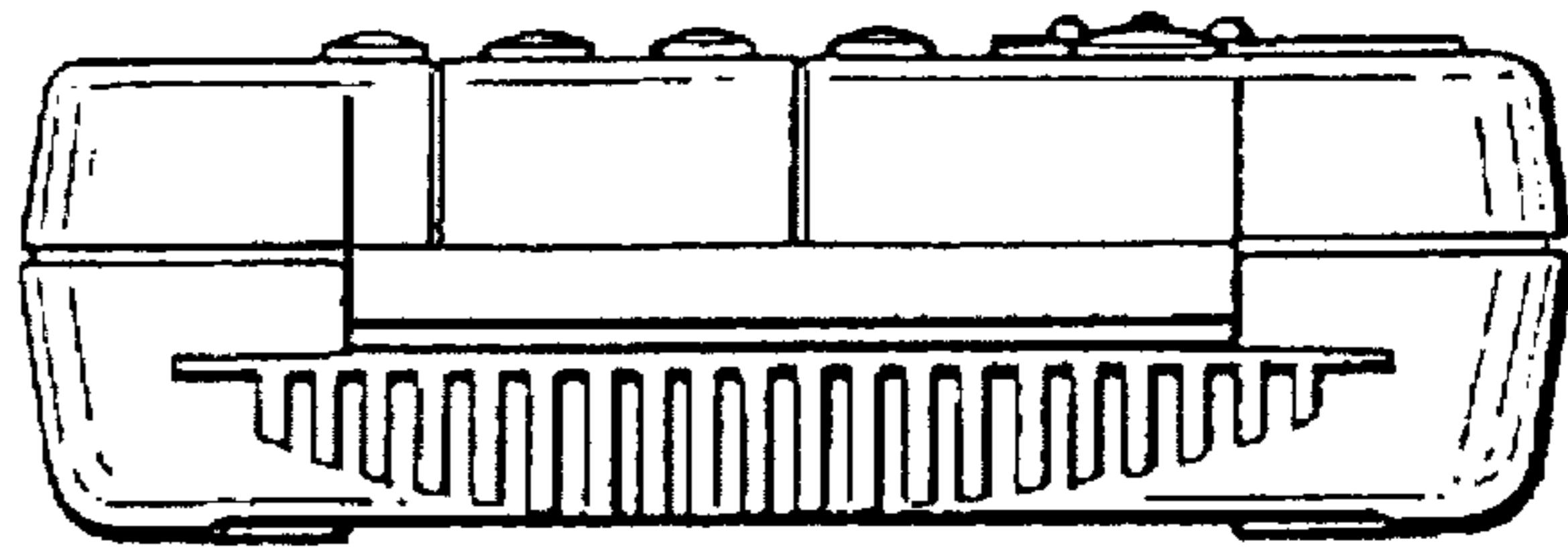

FIG.-3

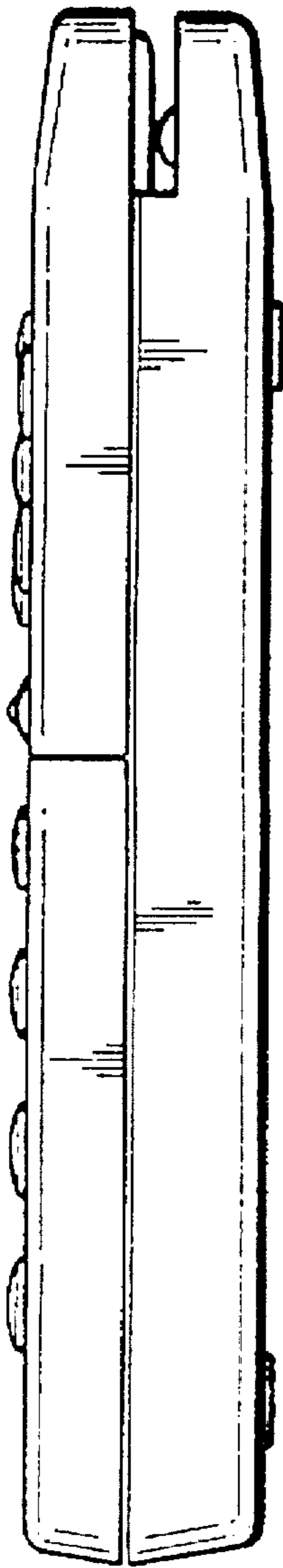

FIG.-4

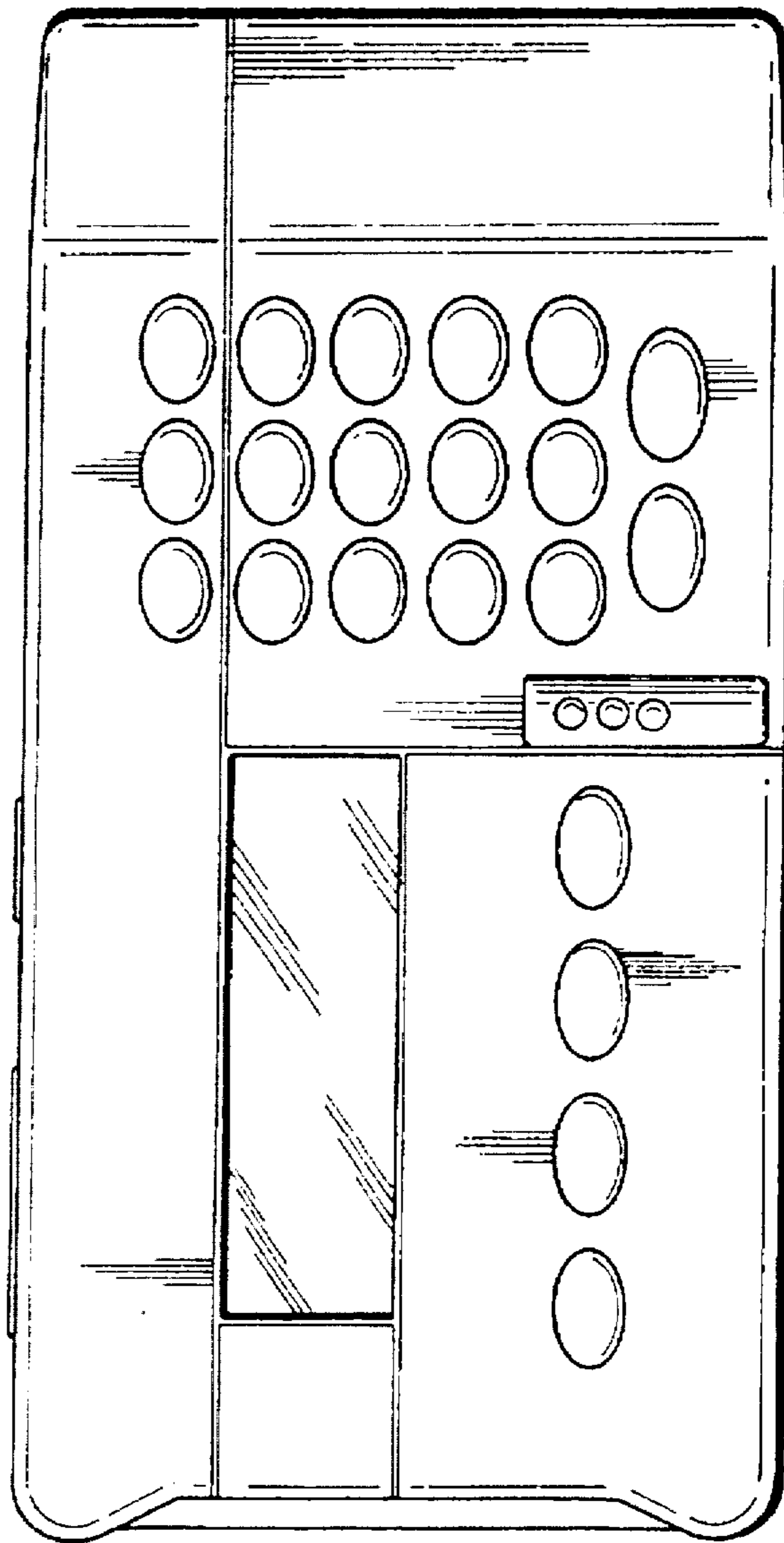

FIG.-5

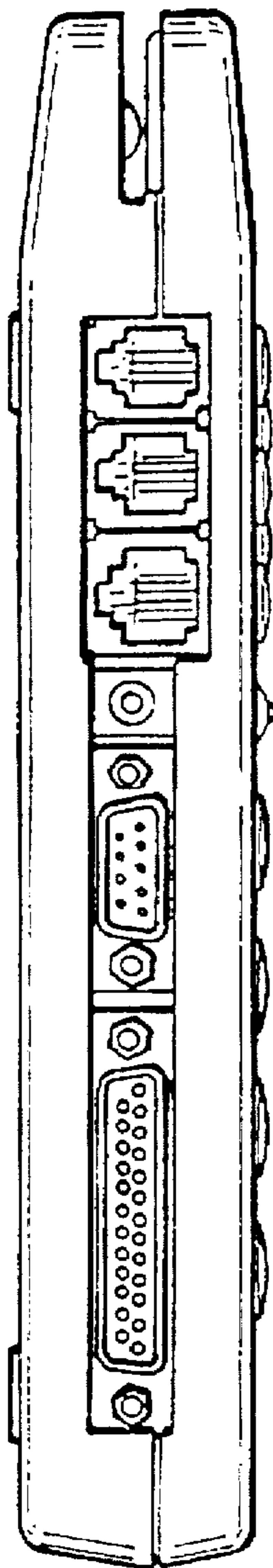

FIG.-6

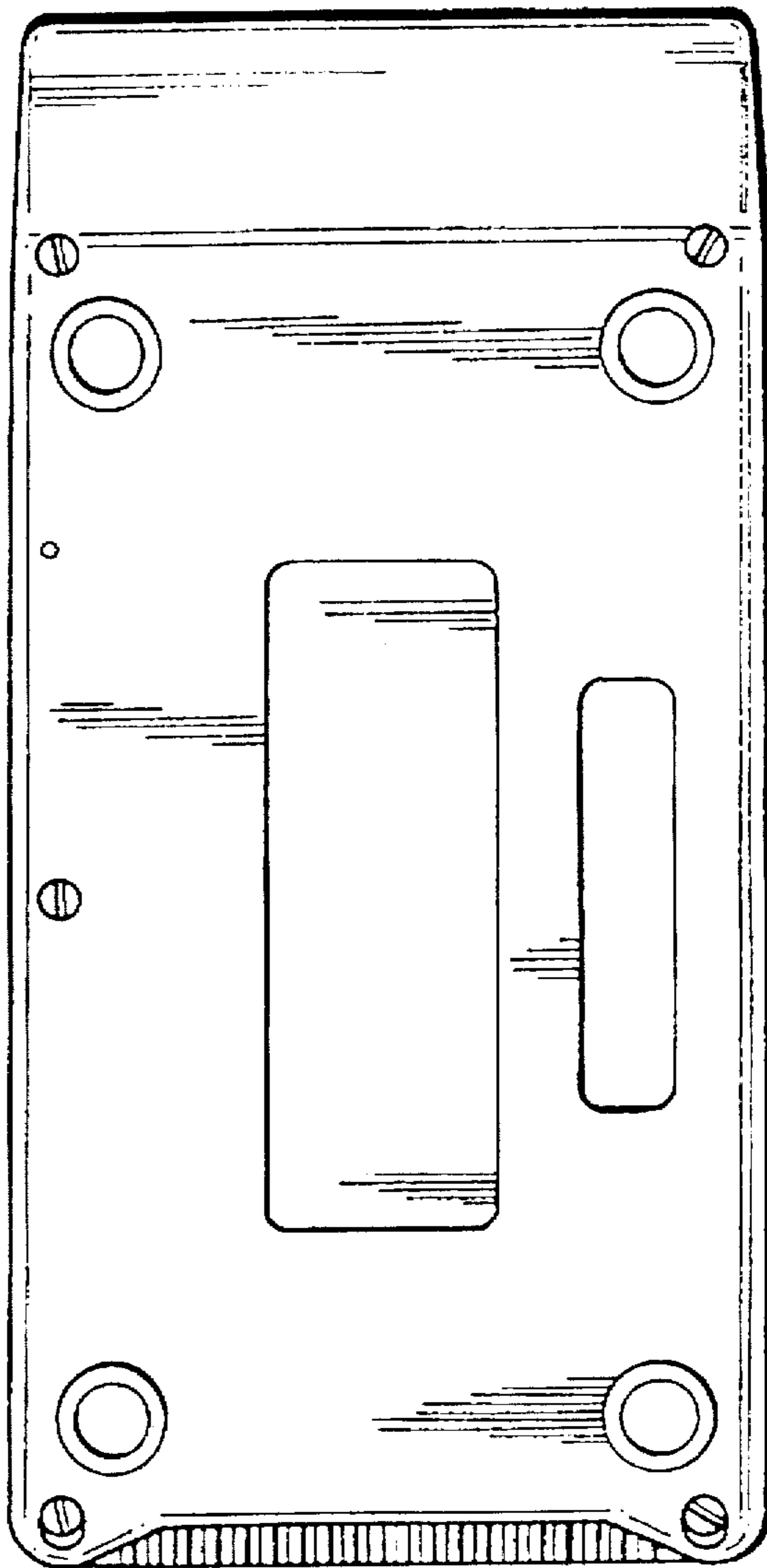

FIG.-7

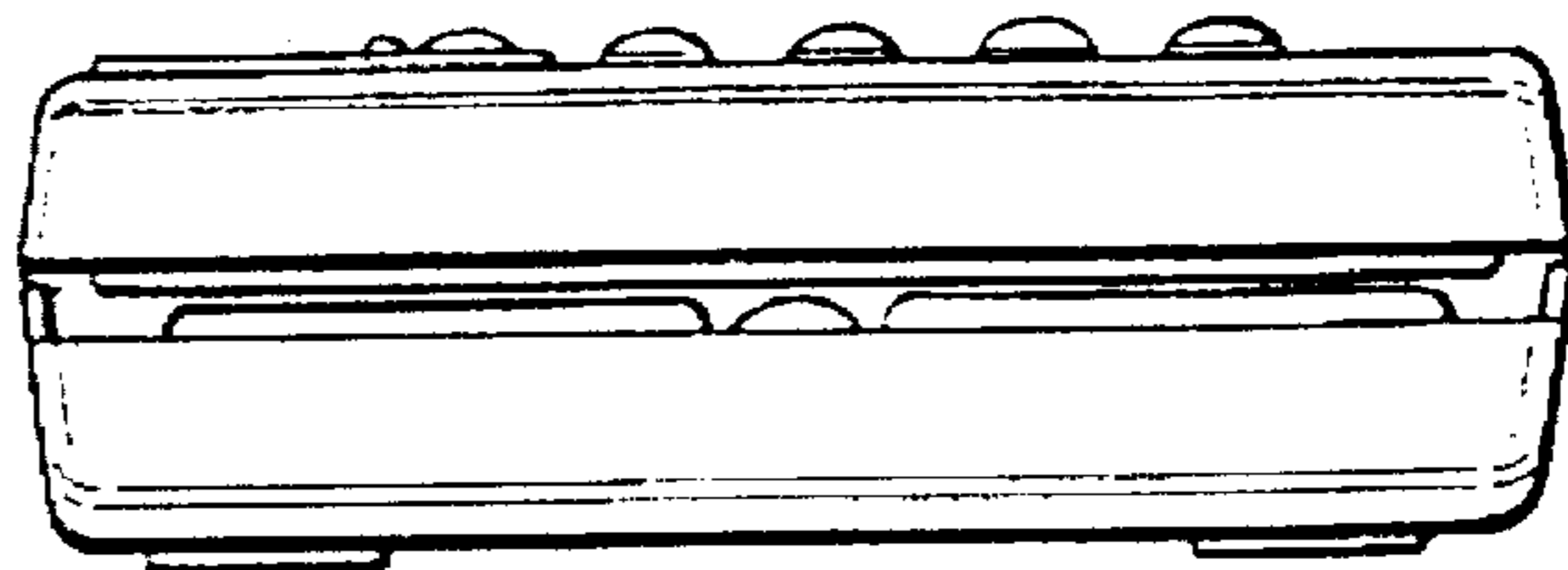

FIG.-8

UNITED STATES PATENT AND TRADEMARK OFFICE  
**CERTIFICATE OF CORRECTION**

PATENT NO. : D390,204

DATED : February 3, 1998

INVENTOR(S) : Javier Antonio de la Fuente Monge

It is certified that error appears in the above-identified patent and that said Letters Patent is hereby corrected as shown below:

On the title page, item [19] "Fuenie" should read -- Fuente --  
item [75] change

Javier Antonio de la Fuenie Monge to

--Javier Antonio de la Fuente Monge--.

Signed and Sealed this

Twenty-first Day of July, 1998



*Attest:*

BRUCE LEHMAN

*Attesting Officer*

*Commissioner of Patents and Trademarks*