



US00D390044S

United States Patent [19]

Brunner et al.

[11] Patent Number: Des. 390,044

[45] Date of Patent: **Feb. 3, 1998

[54] DRESSER

[75] Inventors: **Merlin A. Brunner**, Appleton; **Harvey J. Draheim**, Weyauwega, both of Wis.

[73] Assignee: **Simmons Juvenile Products Company, Inc.**, New London, Wis.

[**] Term: 14 Years

[21] Appl. No.: 58,789

[22] Filed: Aug. 22, 1996

[51] LOC (6) Cl. 06-04

[52] U.S. Cl. D6/439

[58] Field of Search D6/432, 436-439, D6/441, 442, 445-448; 312/108, 198, 204

[56] References Cited

U.S. PATENT DOCUMENTS

D. 126,985	5/1941	Miller	D6/441
D. 129,483	9/1941	Jiranek	D6/441
D. 146,375	2/1947	Obrig	D6/446
D. 168,840	2/1953	Herrman et al.	D6/441

Primary Examiner—Janice E. Seeger

Attorney, Agent, or Firm—Hoffmann & Baron, LLP

[57] CLAIM

The ornamental design for a dresser, as shown and described.

DESCRIPTION

FIG. 1 is a top perspective view of a dresser showing our new design;

FIG. 2 is a top plan view thereof;

FIG. 3 is a front elevation view thereof;

FIG. 4 is a side elevation view thereof, the opposite side being a mirror image thereof;

FIG. 5 is a rear elevation view thereof;

FIG. 6 is a bottom plan view thereof;

FIG. 7 is a top perspective view of a dresser showing an alternative embodiment of our new design;

FIG. 8 is a top plan view thereof;

FIG. 9 is a front elevation view thereof;

FIG. 10 is a side elevation view thereof, the opposite side being a mirror image thereof;

FIG. 11 is a rear elevation view thereof;

FIG. 12 is a bottom plan view thereof;

FIG. 13 is a sectional view taken along line 13—13 of FIG. 3 and FIG. 9;

FIG. 14 is an enlarged sectional view taken along line 14—14 of FIG. 3 and of FIG. 9; and,

FIG. 15 is an enlarged sectional view taken along line 15—15 of FIG. 3 and of FIG. 9.

1 Claim, 14 Drawing Sheets

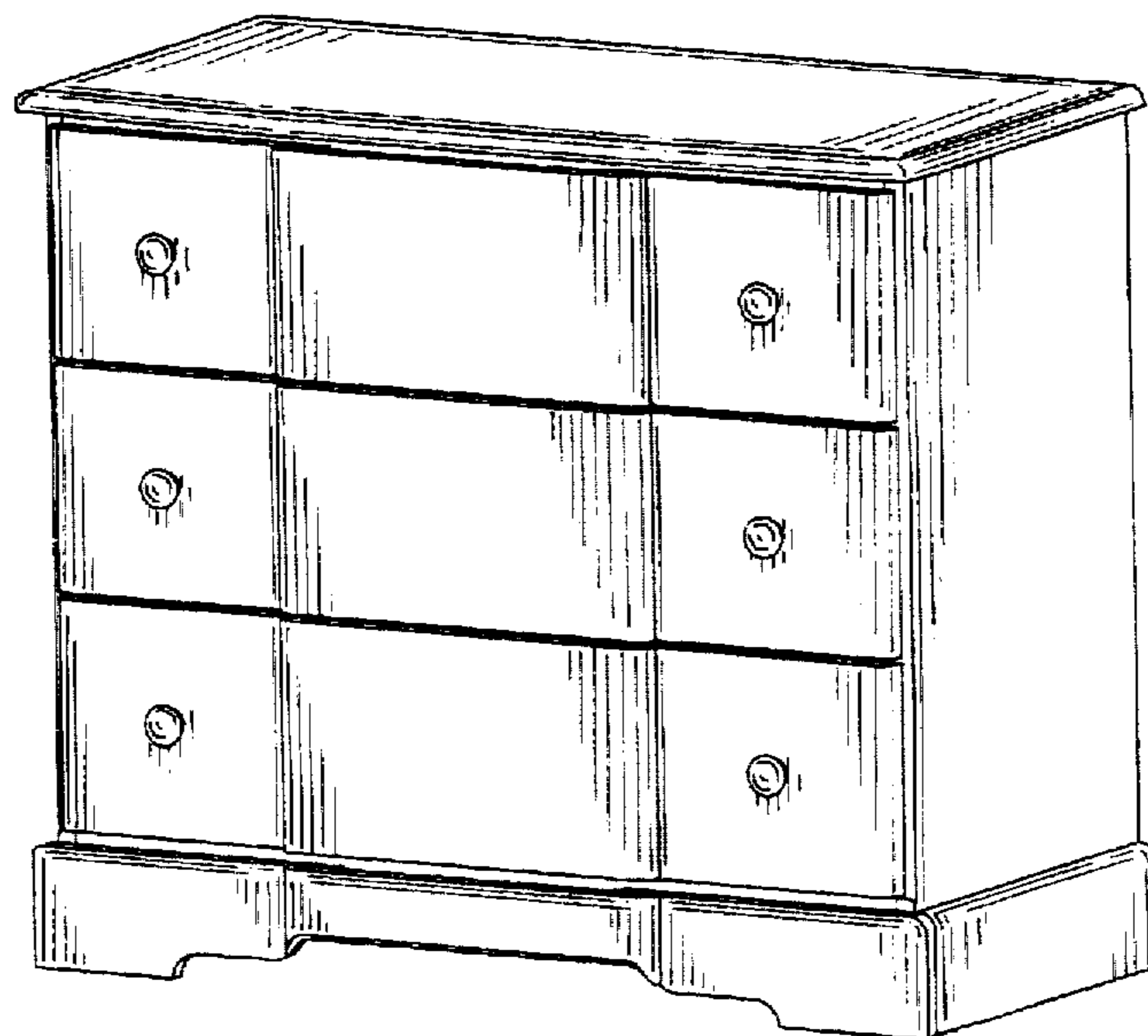

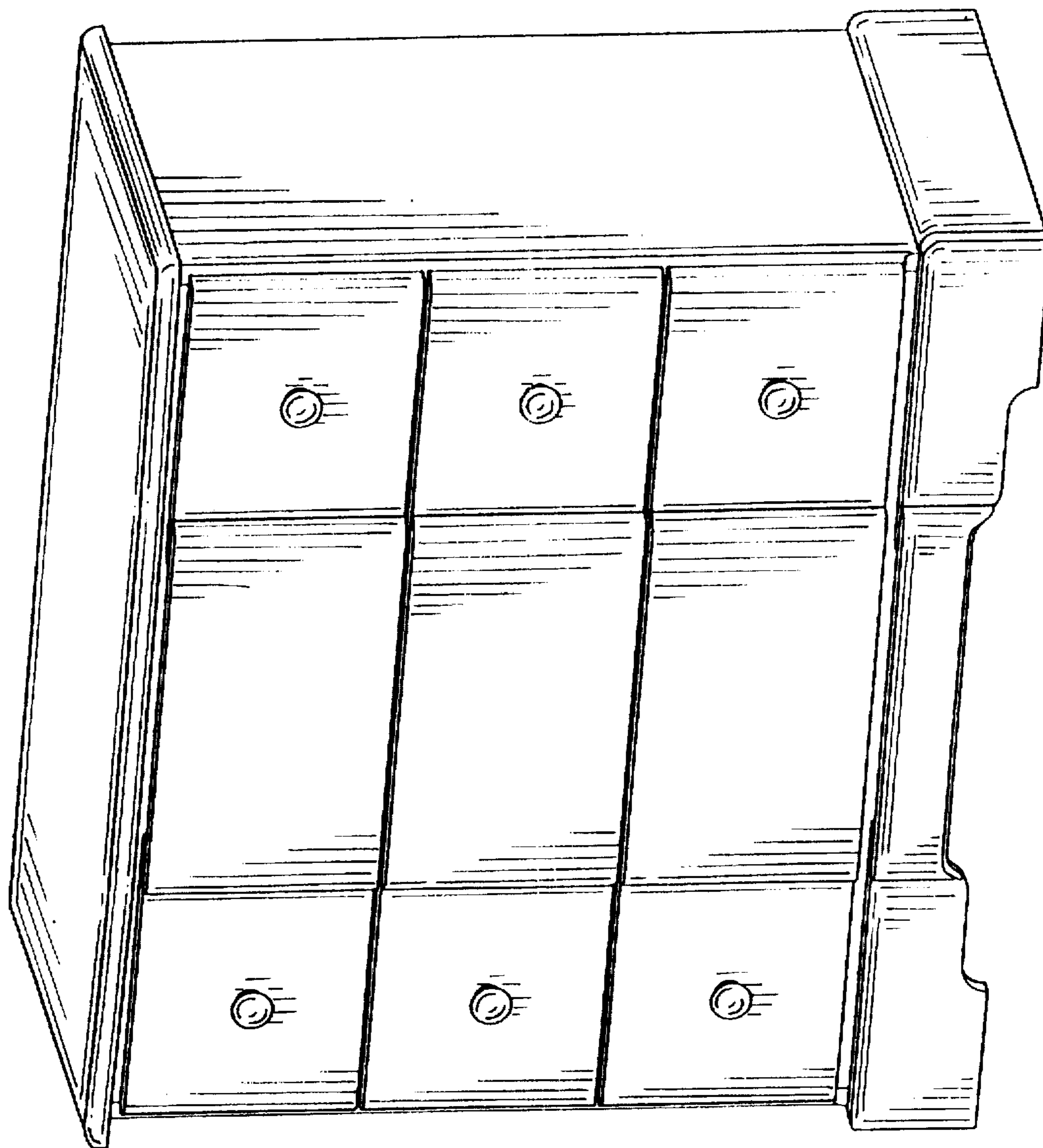

FIG - 1

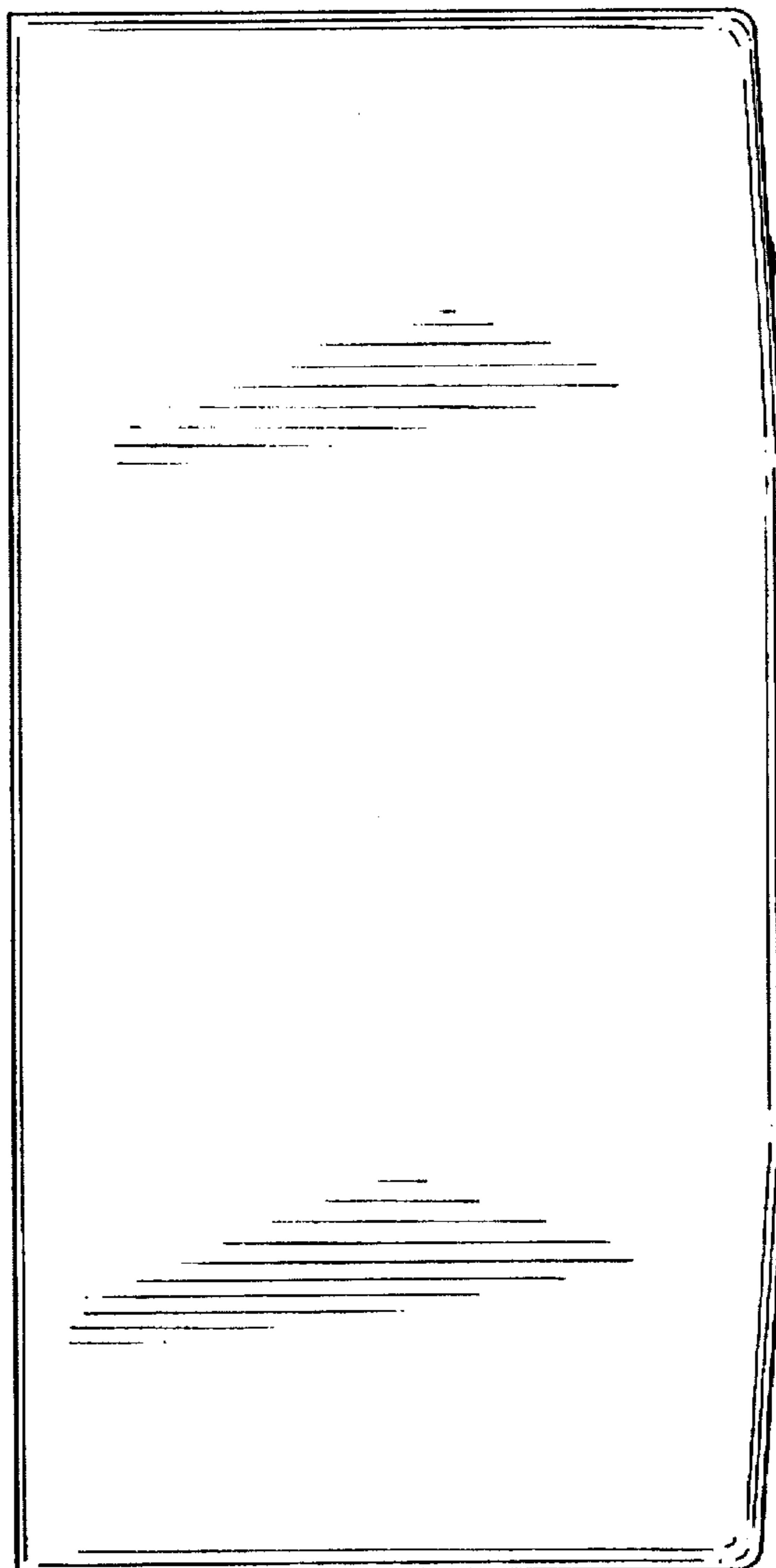

FIG - 2

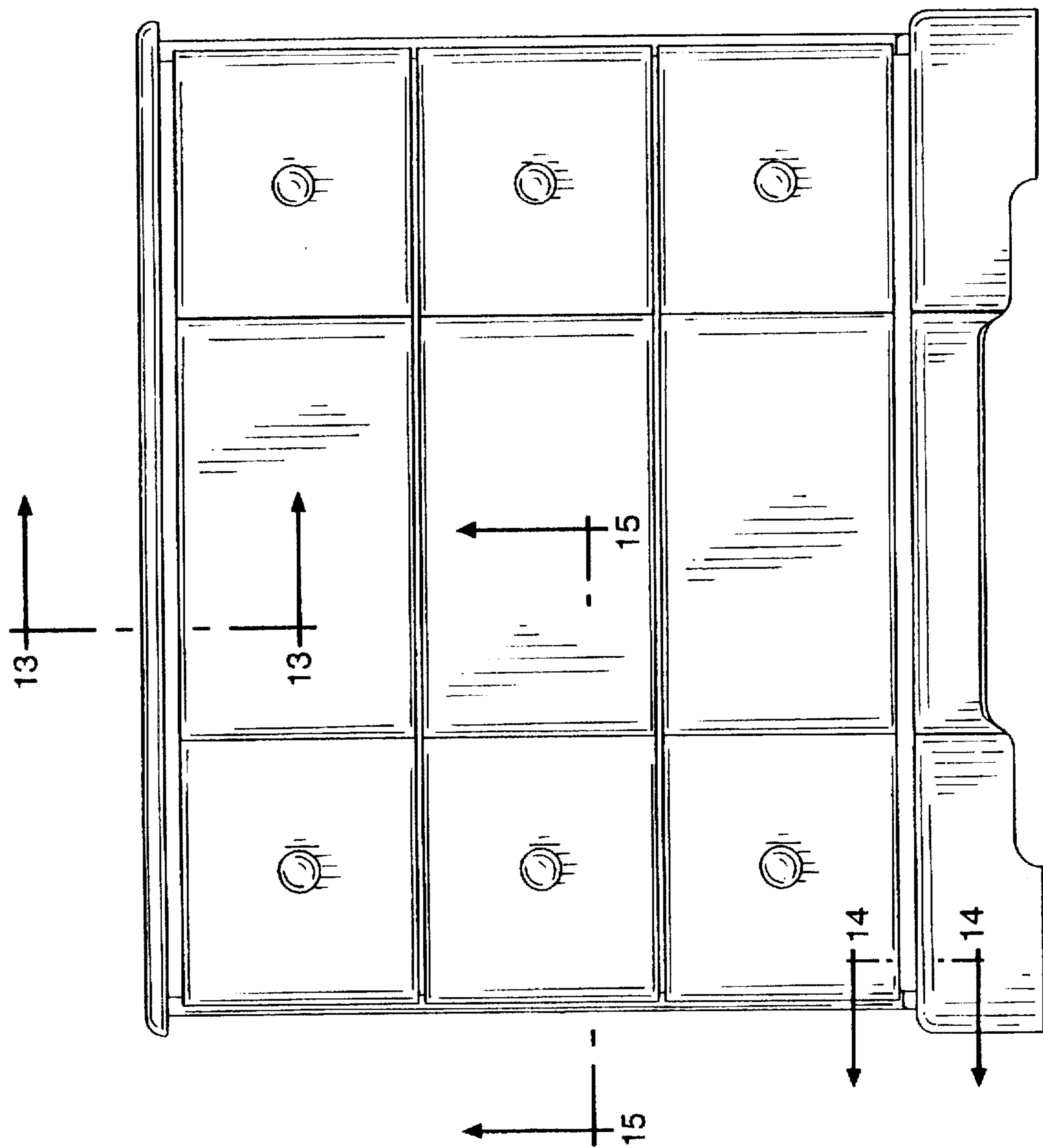
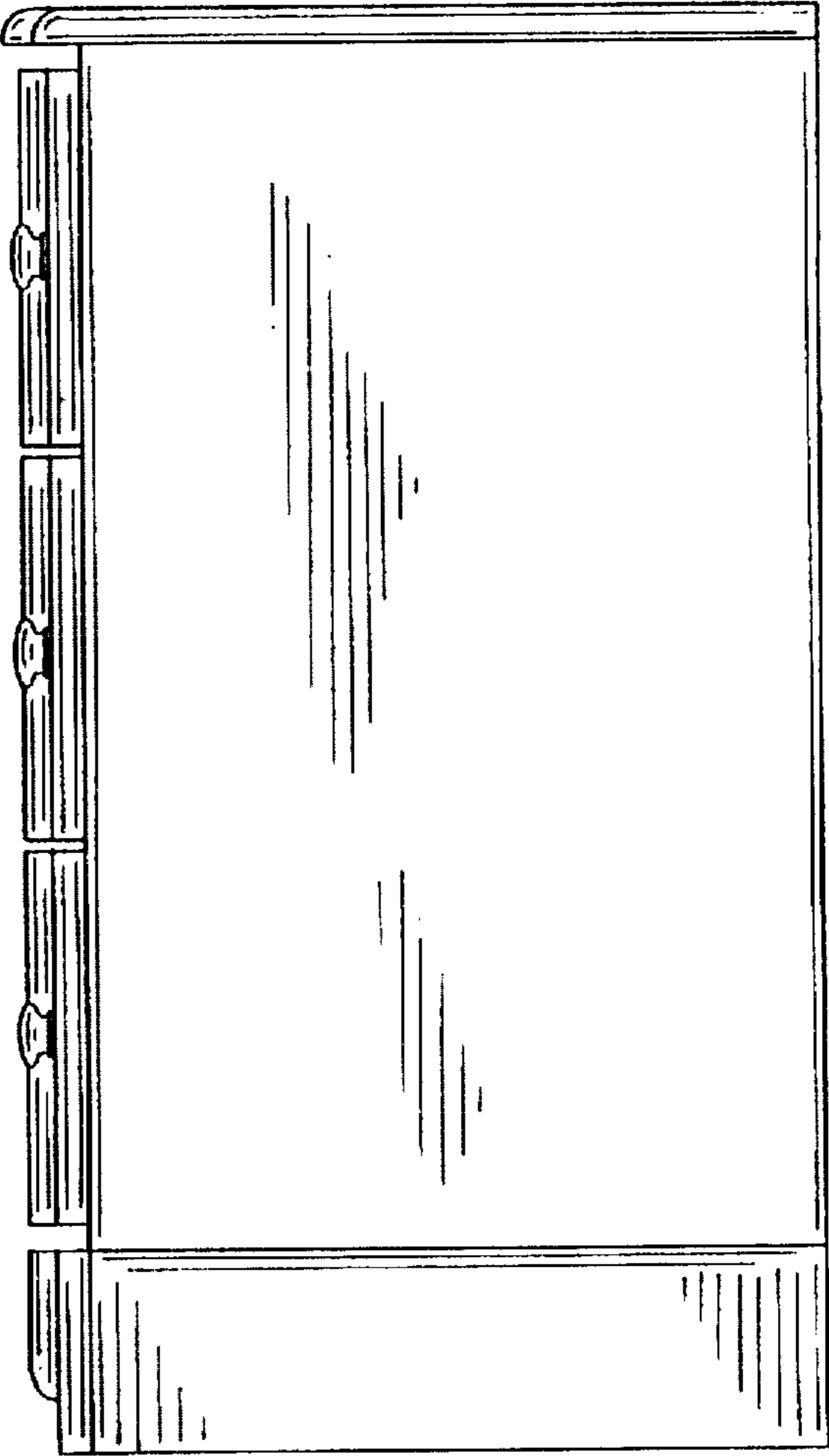

FIG - 3

FIG - 4



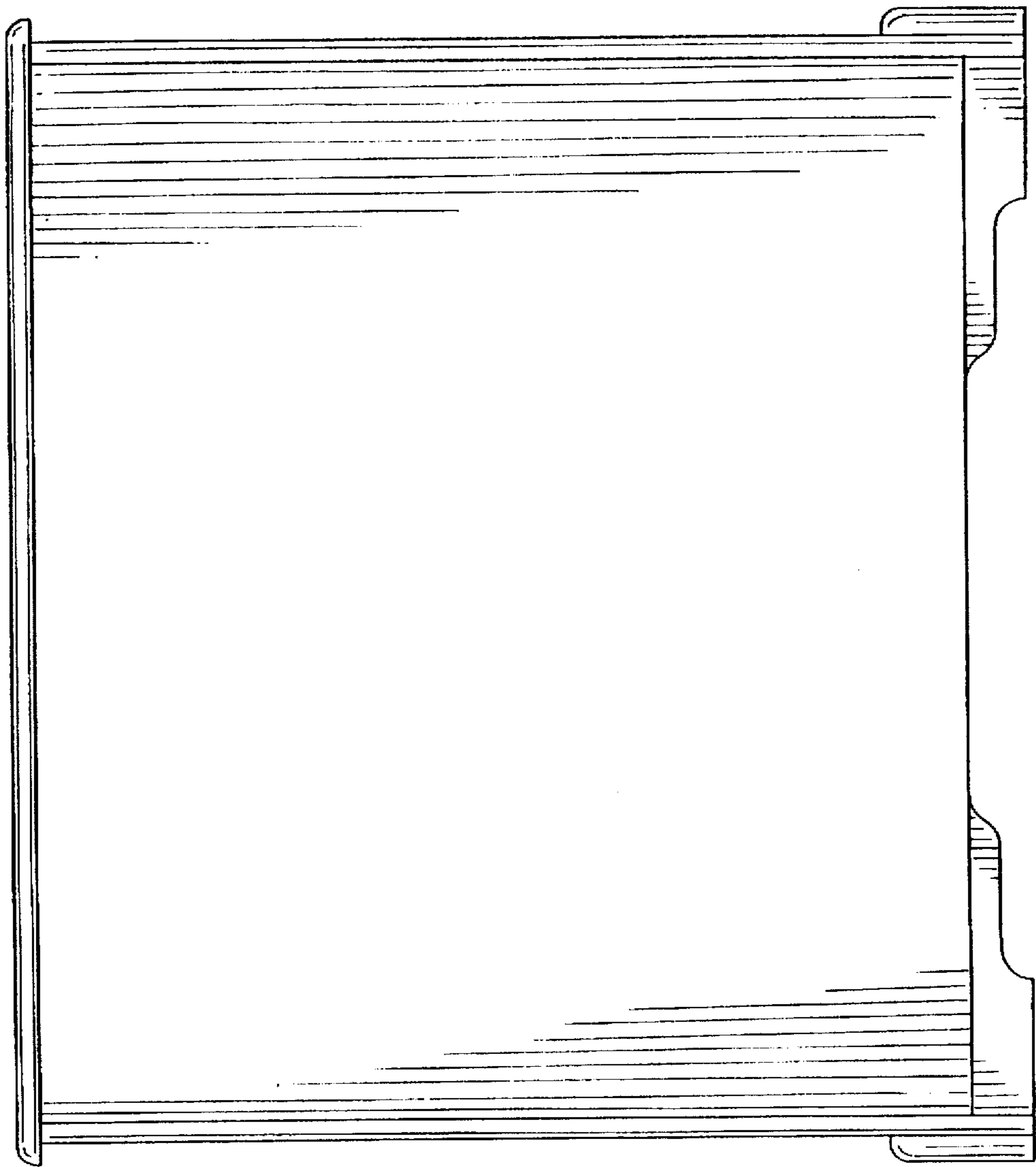

FIG - 5

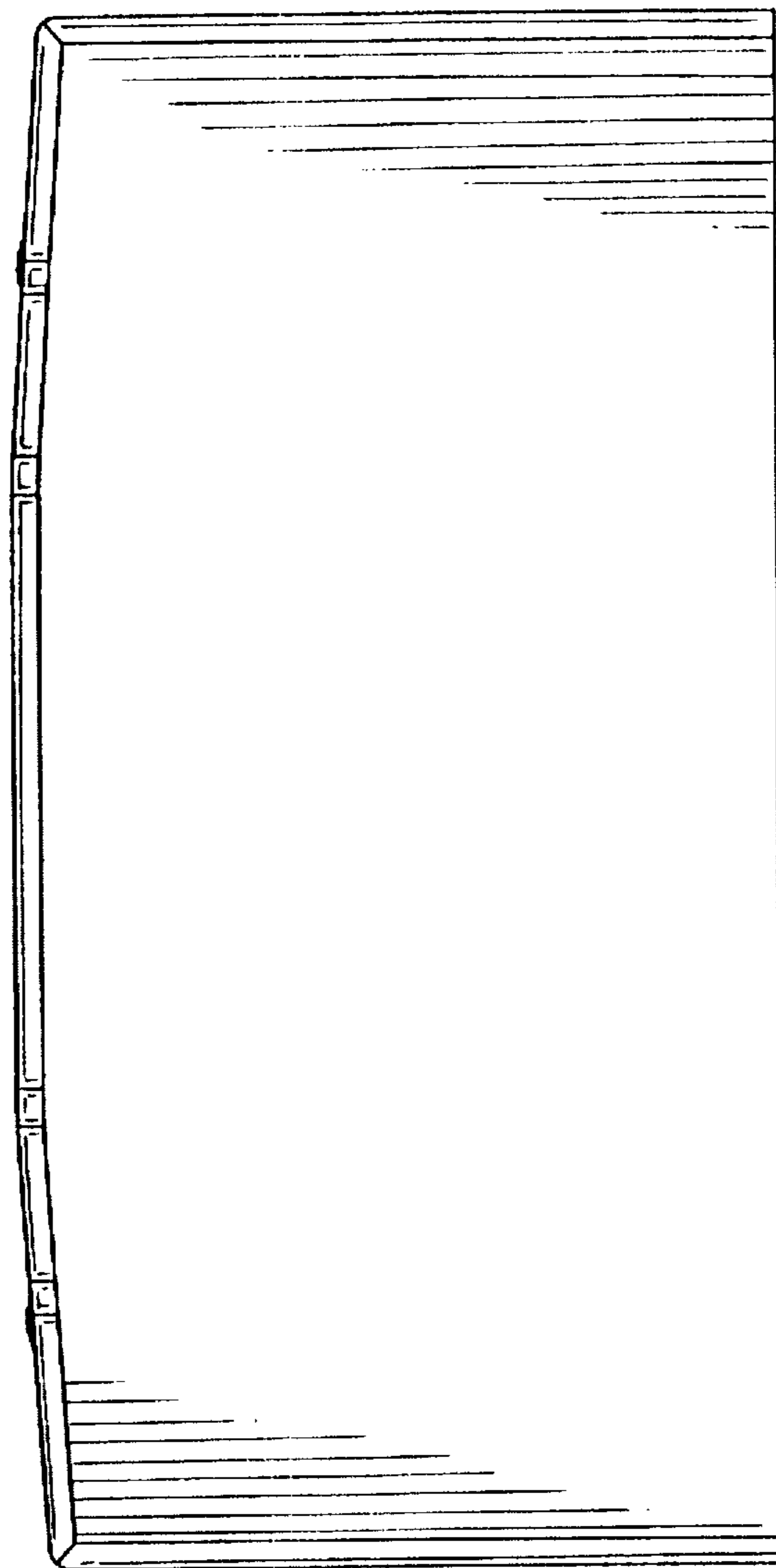
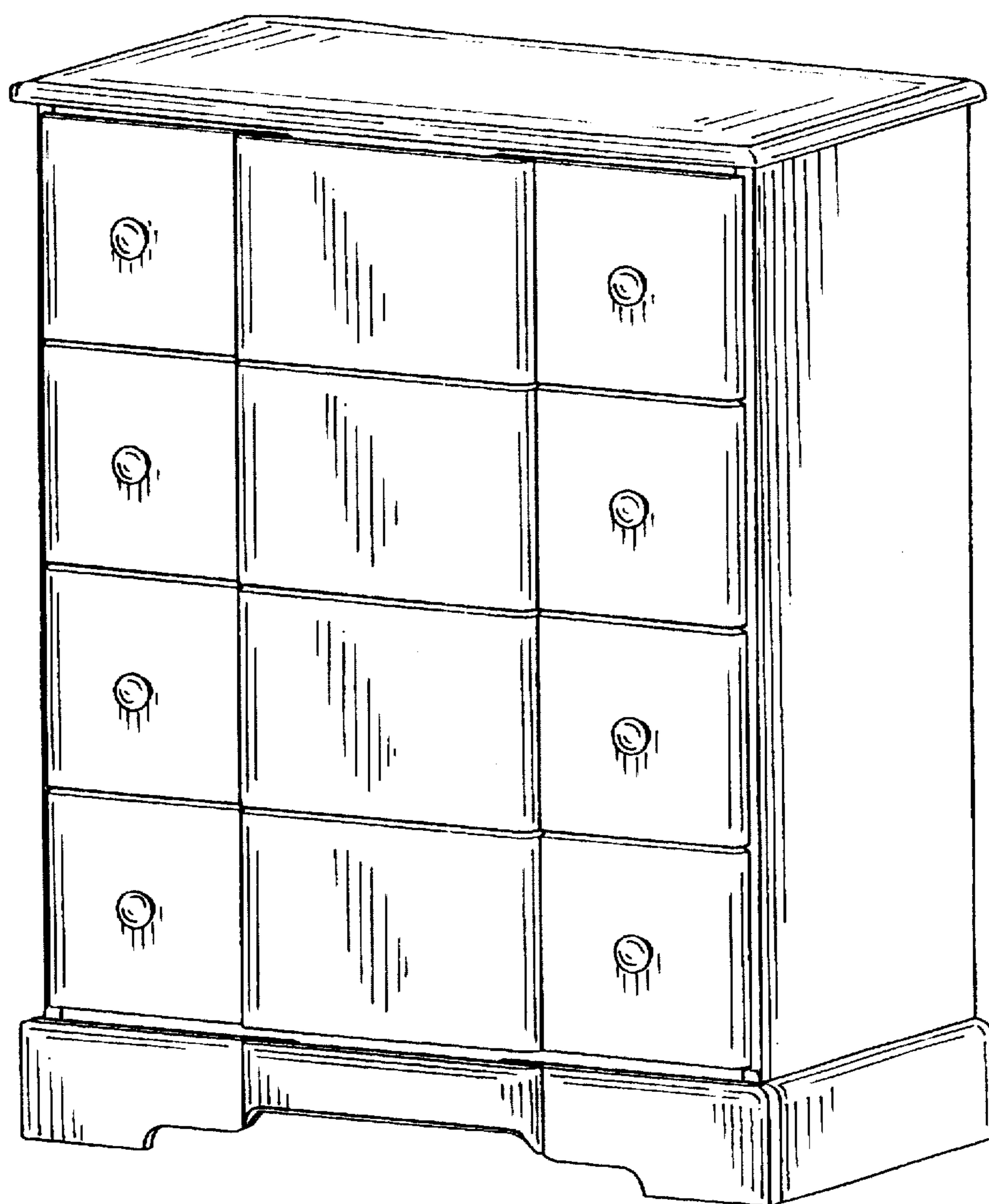

FIG - 6

FIG - 7



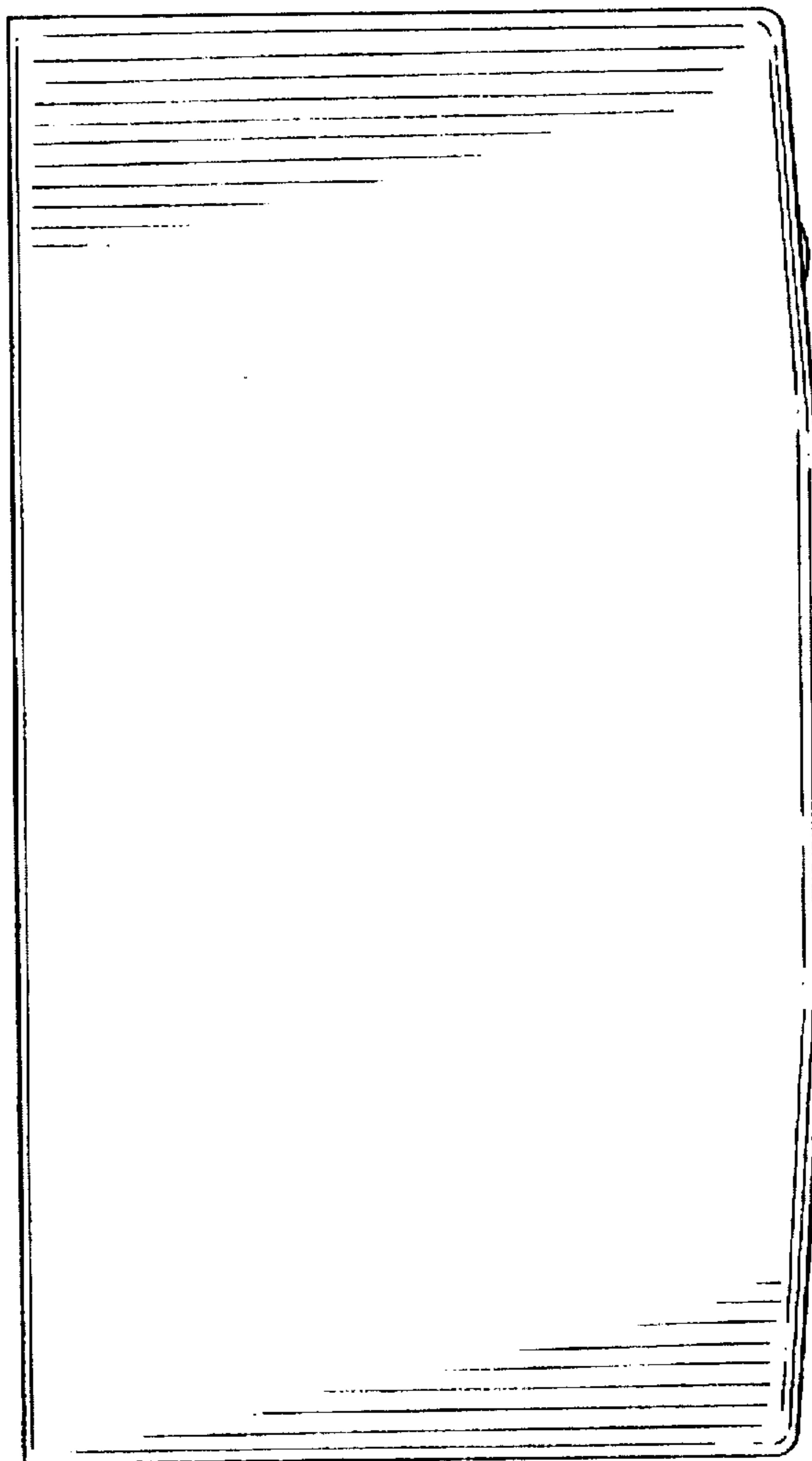

FIG - 8

FIG - 9

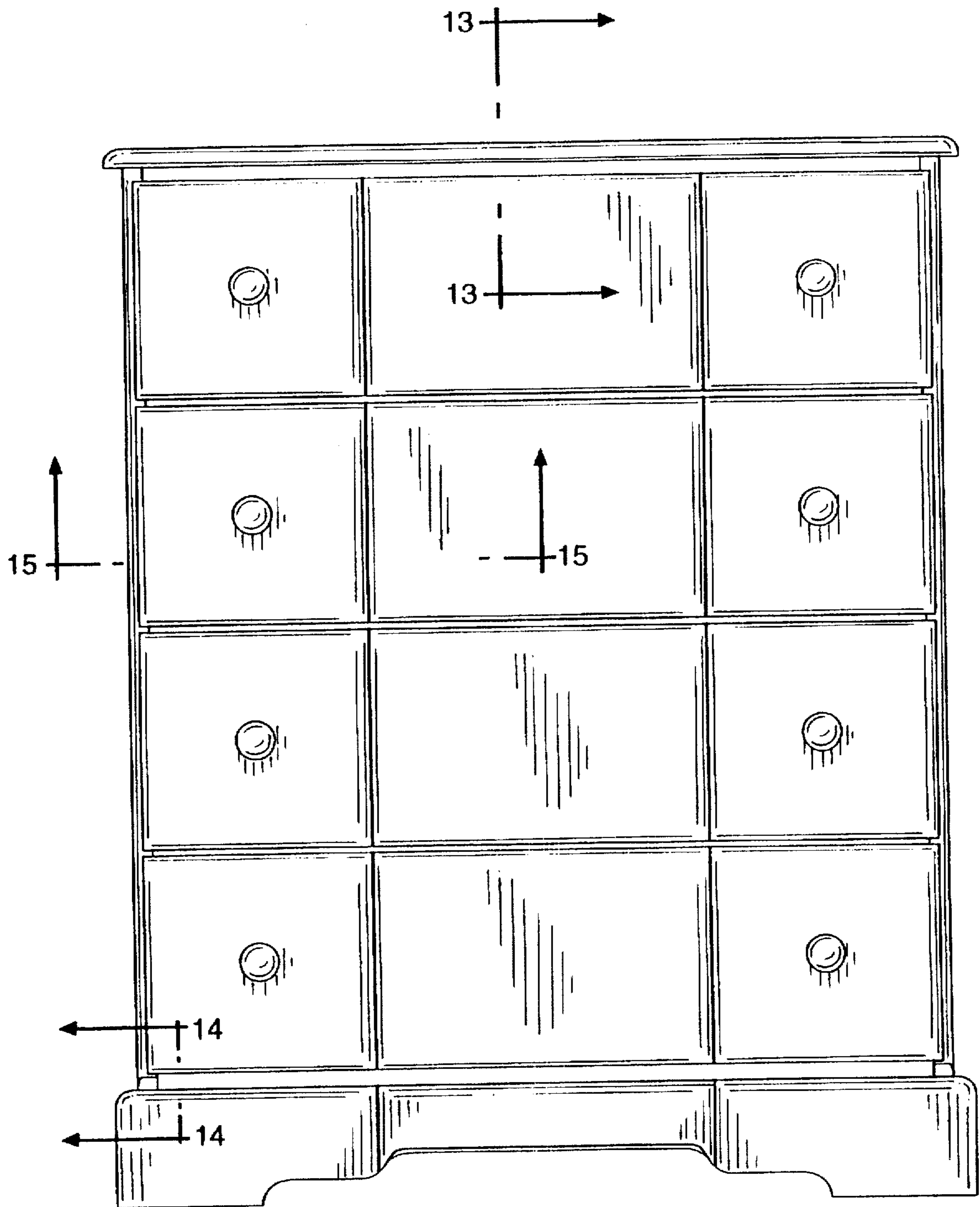

FIG - 10

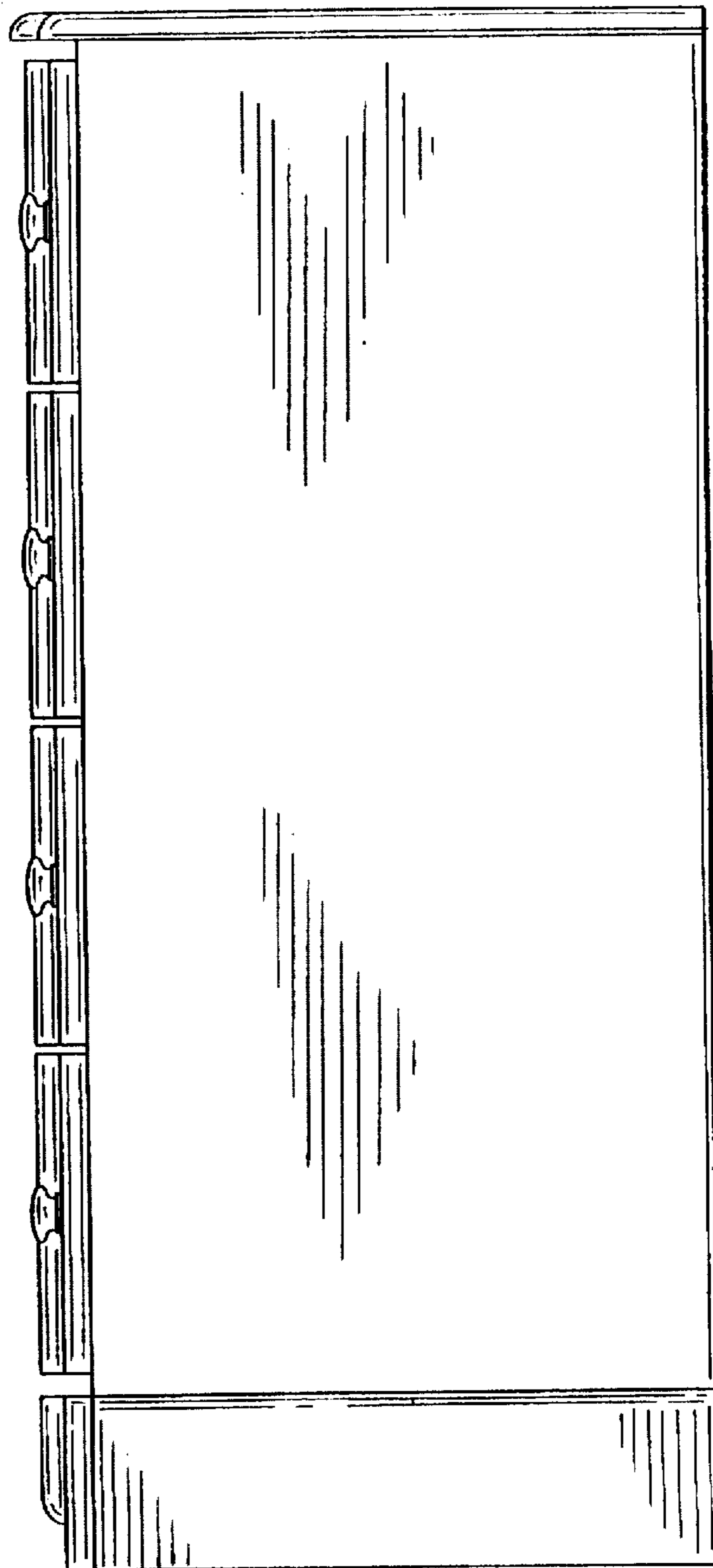
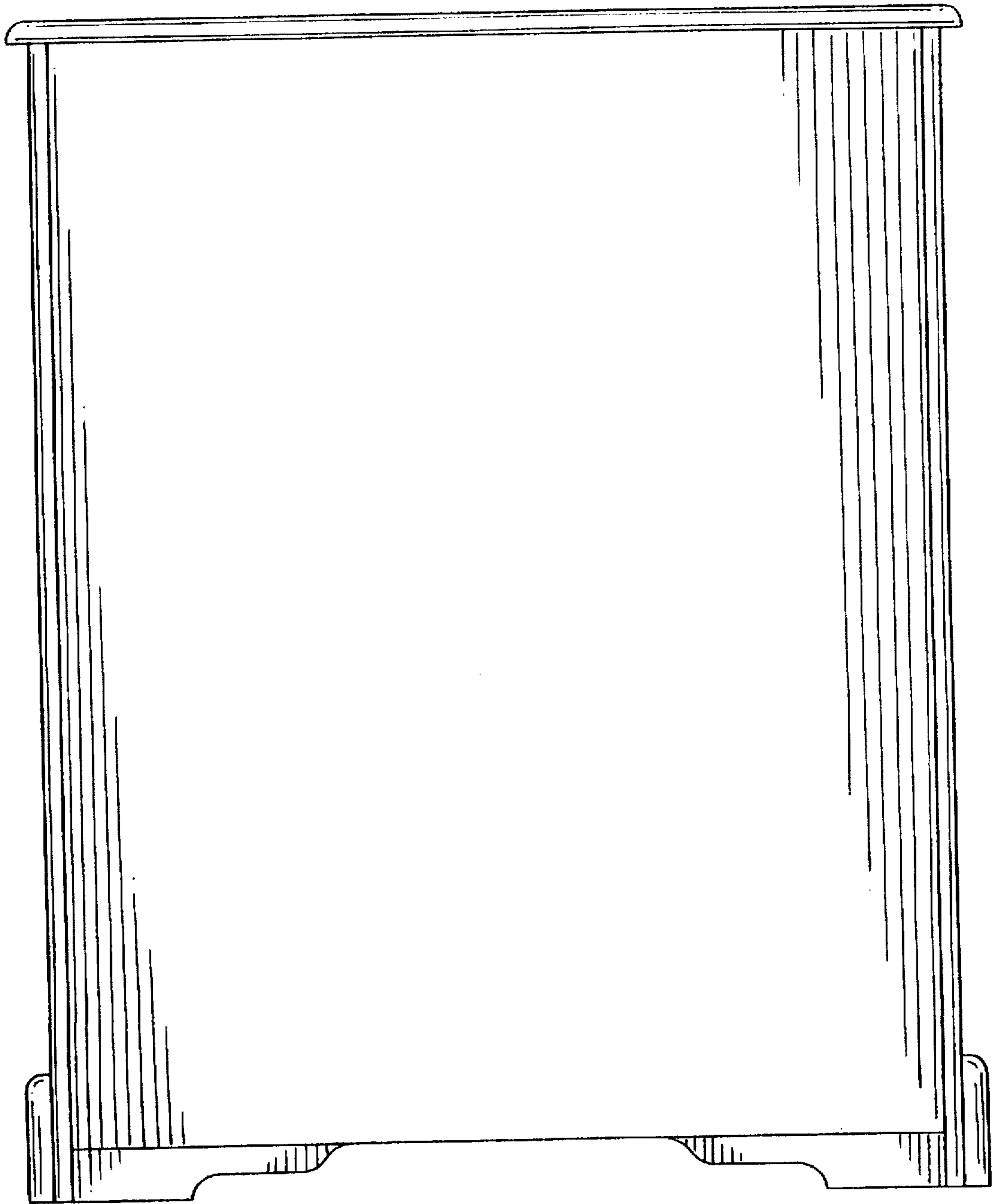

FIG - 11



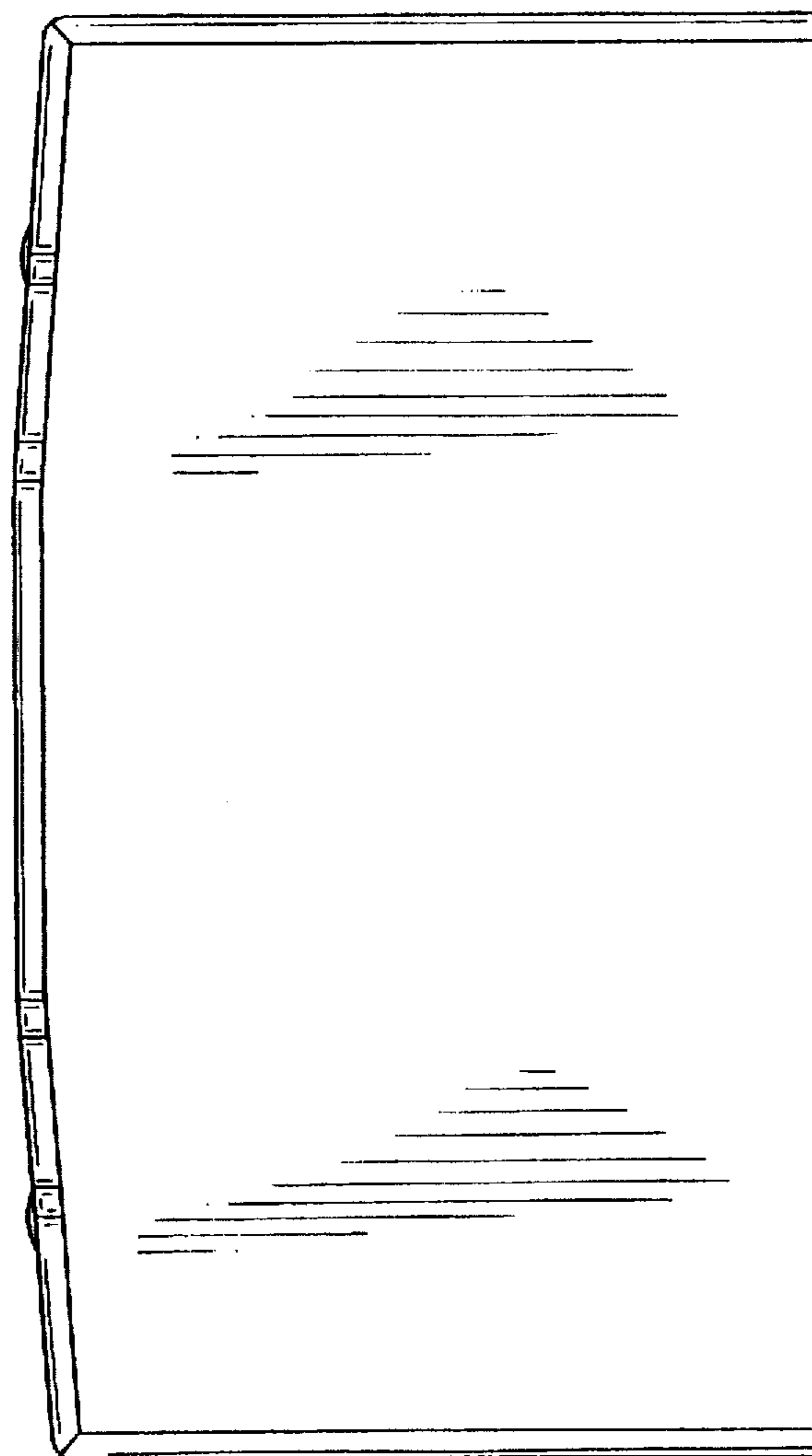

FIG - 12

FIG - 14

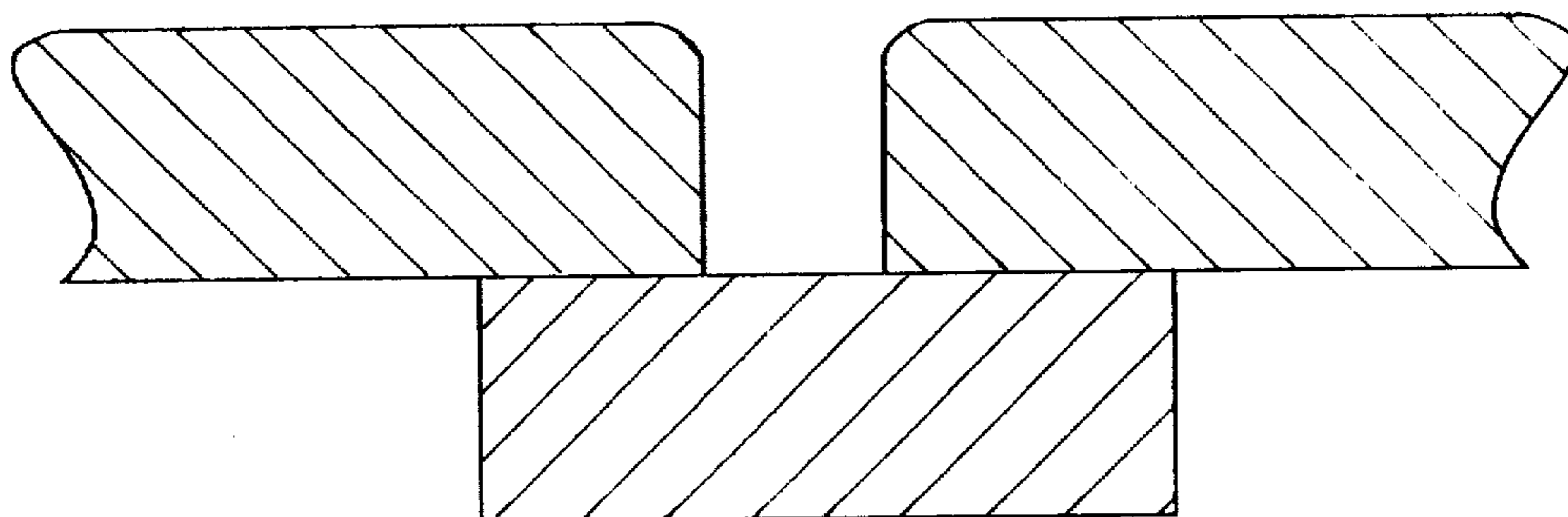

FIG - 13

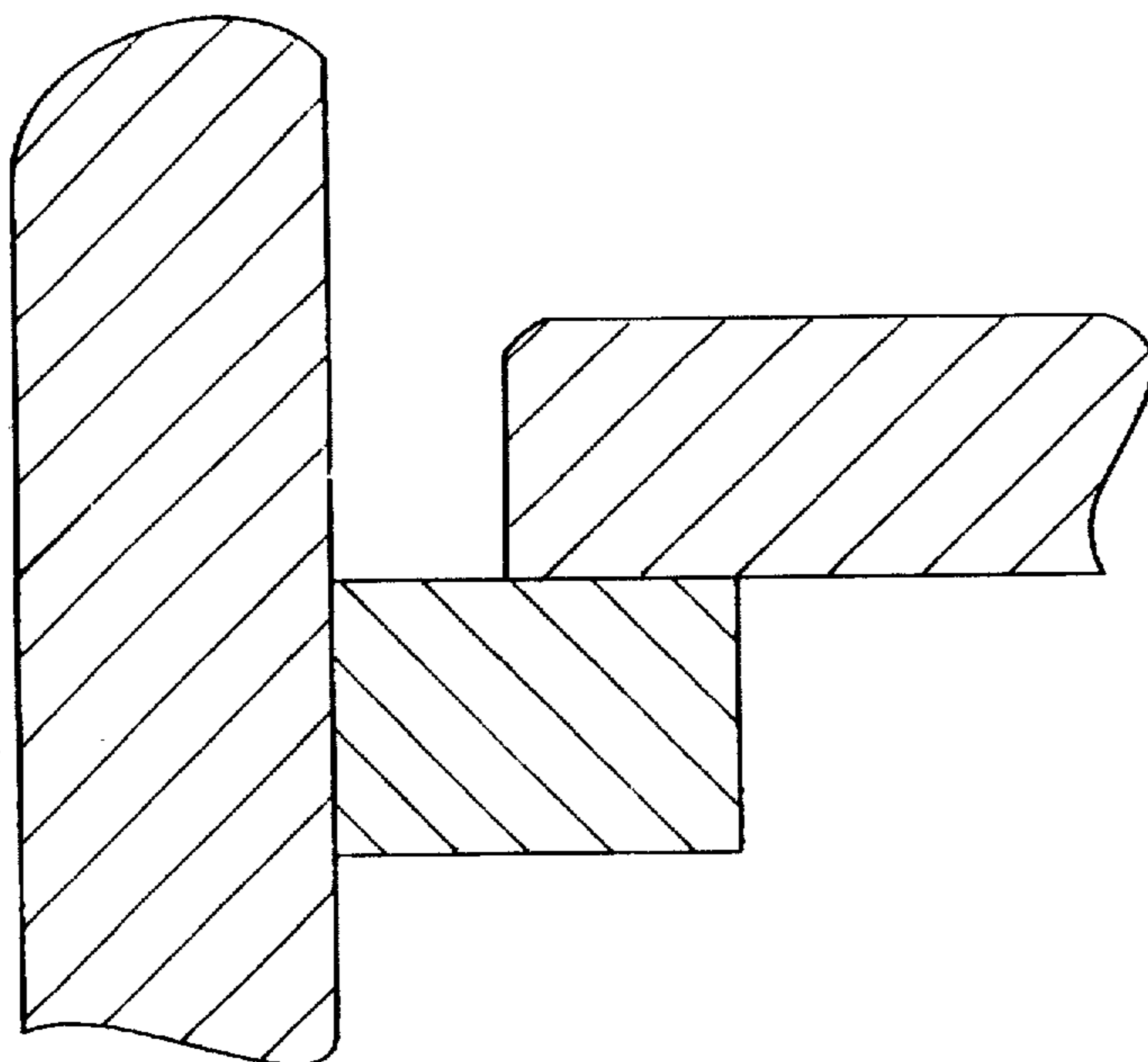

FIG - 15

