



US00D390033S

United States Patent [19]

Natuzzi et al.

[11] Patent Number: **Des. 390,033**

[45] Date of Patent: ****Feb. 3, 1998**

[54] SEAT

[75] Inventors: **Pasquale Natuzzi; Raffaella Lucarelli,**
both of Santeramo in Colle, Italy

[73] Assignee: **Industrie Natuzzi, Spa, Bari, Italy**

[**] Term: **14 Years**

[21] Appl. No.: **64,369**

[22] Filed: **Dec. 30, 1996**

[51] LOC (6) Cl. **06-01**

[52] U.S. Cl. **D6/381; D6/334**

[58] Field of Search **D6/334, 335, 364,**
D6/371, 373, 381, 500, 501, 502; 297/232,
445.1

[56] References Cited

U.S. PATENT DOCUMENTS

D. 298,192	10/1988	Owen	D6/381
D. 362,979	10/1995	Natuzzi et al.	D6/381
D. 364,975	12/1995	Natuzzi et al.	D6/381
D. 367,371	2/1996	Natuzzi et al.	D6/381

OTHER PUBLICATIONS

Natuzzi Model 484, Apr., 1989, at International Home Furnishings Market in High Point, North Carolina.
 Natuzzi Model 1043, Apr., 1993, at International Home Furnishings Market in High Point, North Carolina.
 Natuzzi Model 1059, Apr., 1993, at International Home Furnishings Market in High Point, North Carolina.
 Natuzzi Model 1068, Oct., 1993, at International Home Furnishings Market in High Point, North Carolina.
 Natuzzi Model 1074, Oct., 1993, at International Home Furnishings Market in High Point, North Carolina.
 Natuzzi Model 1077, Oct., 1993, at International Home Furnishings Market in High Point, North Carolina.
 Natuzzi Model 1083, Oct., 1993, at International Home Furnishings Market in High Point, North Carolina.
 Natuzzi Model 1087, Oct., 1993, at International Home Furnishings Market in High Point, North Carolina.
 Natuzzi Model 1094, Oct., 1993, at International Home Furnishings Market in High Point, North Carolina.

Natuzzi Model 1098, Oct., 1993, at International Home Furnishings Market in High Point, North Carolina.
 Natuzzi Model 1110, Oct., 1993, at International Home Furnishings Market in High Point, North Carolina.
 Natuzzi Model 1123, Jan., 1994, at International Home Furnishings Market in High Point, North Carolina.
 Natuzzi Model 1164, Apr., 1994, at International Home Furnishings Market in High Point, North Carolina.
 Natuzzi Model 1200, Oct., 1994, at International Home Furnishings Market in High Point, North Carolina.
 Natuzzi Model 1339, Sep., 1995, at International Home Furnishings Market in High Point, North Carolina.
 Natuzzi Model 1352, Sep., 1995, at International Home Furnishings Market in High Point, North Carolina.

Primary Examiner—Gary D. Watson
 Attorney, Agent, or Firm—Bell, Seltzer, Park & Gibson, P.A.

[57] CLAIM

The ornamental design for a seat, as shown and described.

DESCRIPTION

FIG. 1 is a front perspective view of a seat showing our new design in the form of a sofa;
 FIG. 2 is a front elevational view thereof;
 FIG. 3 is a top plan view thereof;
 FIG. 4 is a right side elevational view, the left side being a mirror image thereof;
 FIG. 5 is a rear perspective view thereof;
 FIG. 6 is a front elevational view of a seat showing our new design in the form of a loveseat; and,
 FIG. 7 is a front elevational view of a seat showing our new design in the form of a chair.
 The broken lines shown herein are for illustrative purposes only and form no part of the claimed design.
 The rear views of FIGS. 6 and 7 are like FIG. 5, the difference being a matter of length.
 The end views of FIGS. 6 and 7 are like that shown in FIG. 4.
 FIGS. 1 and 5 have been shown on an enlarged scale with respect to the other views.

1 Claim, 3 Drawing Sheets

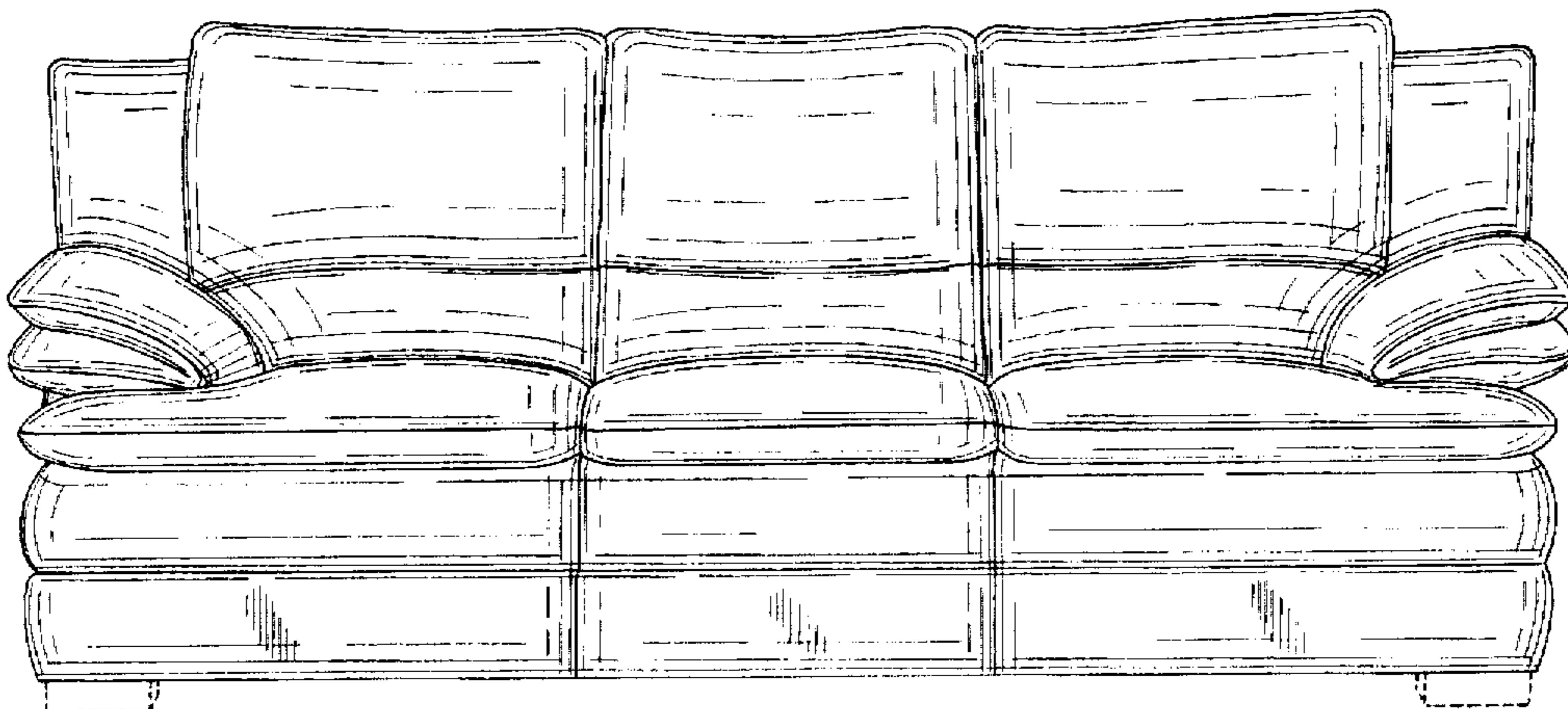

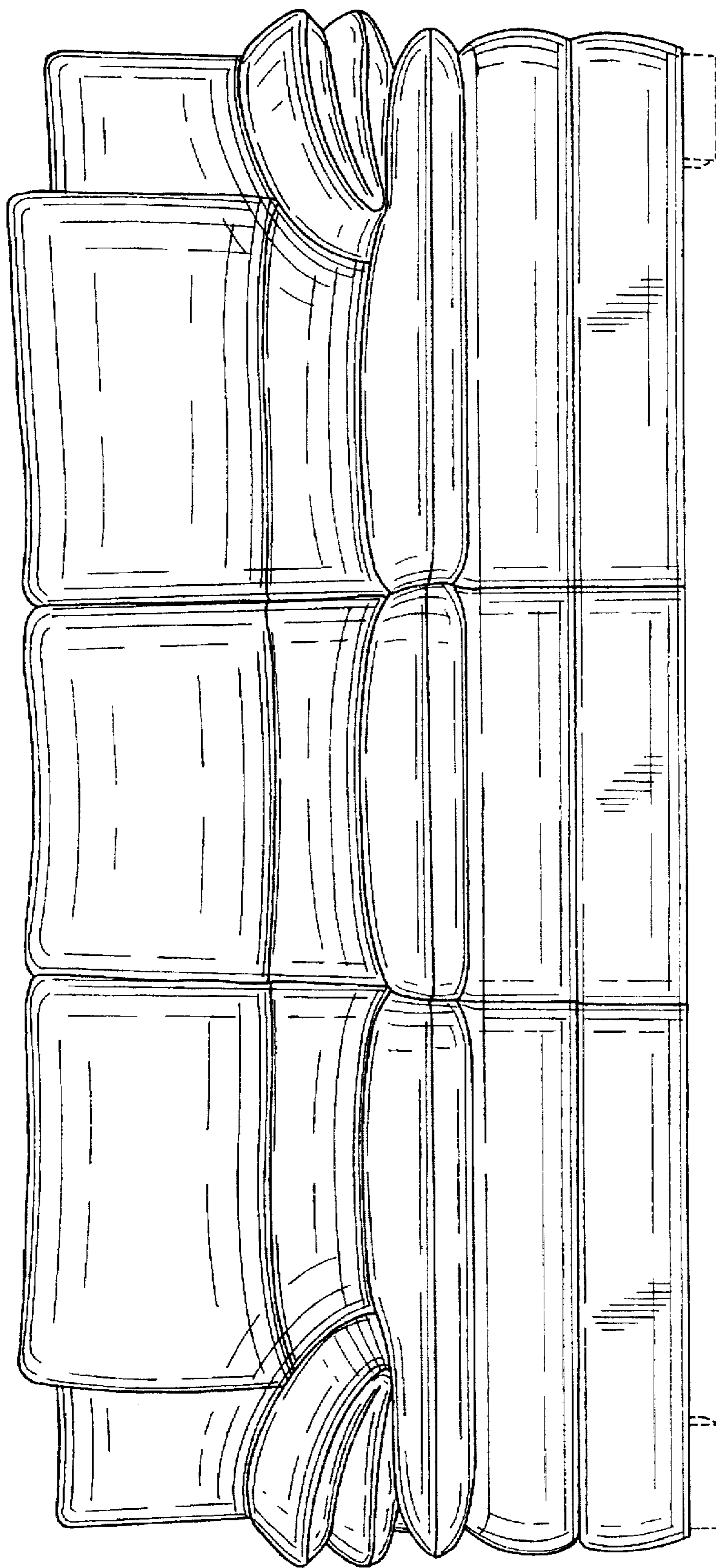

FIG. 1.

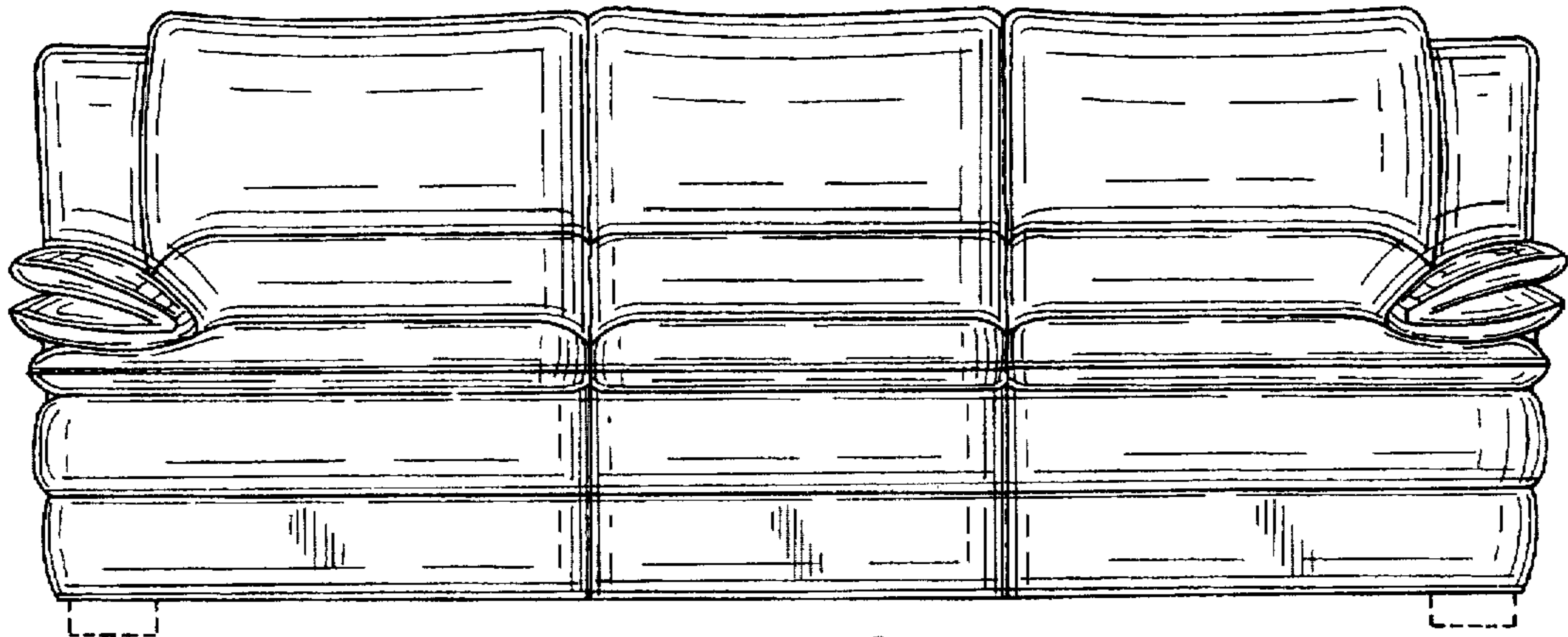

FIG. 2.

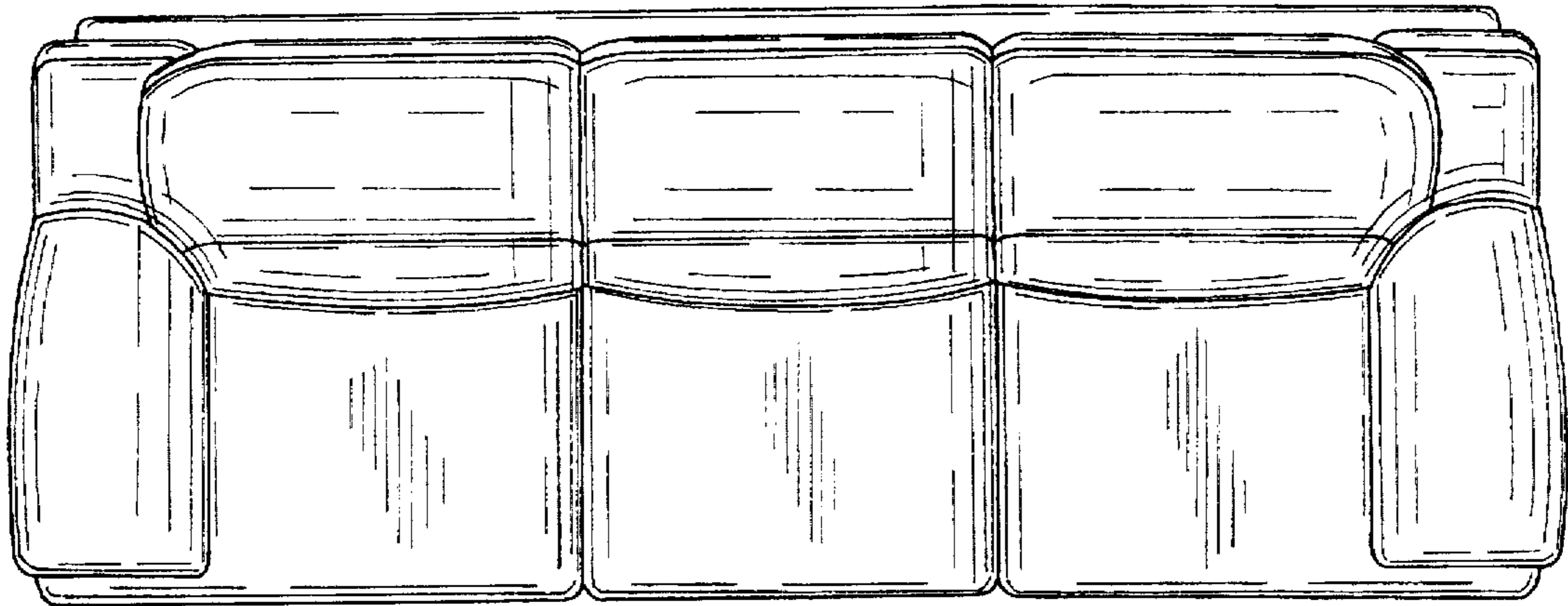

FIG. 3.

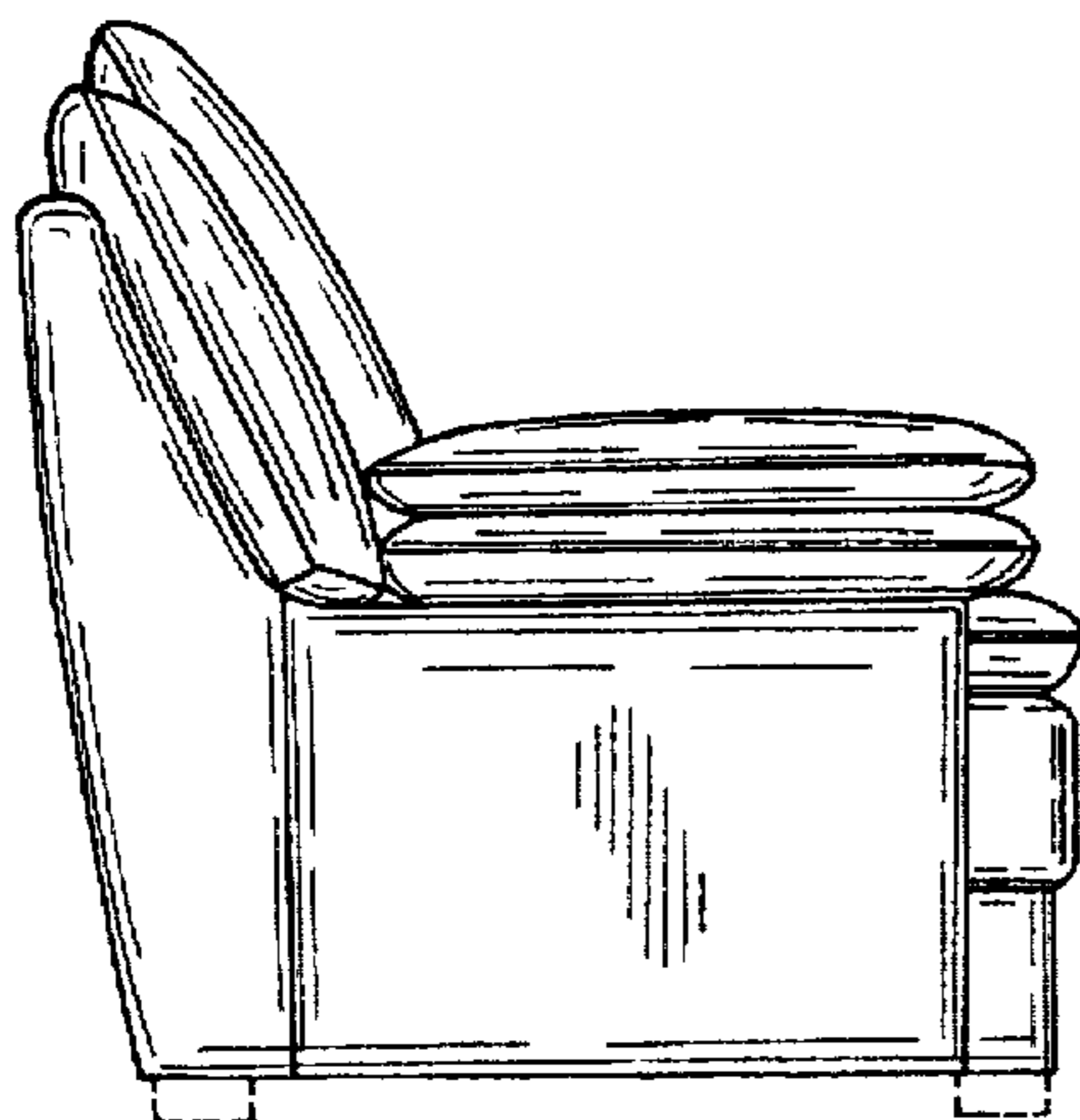

FIG. 4.

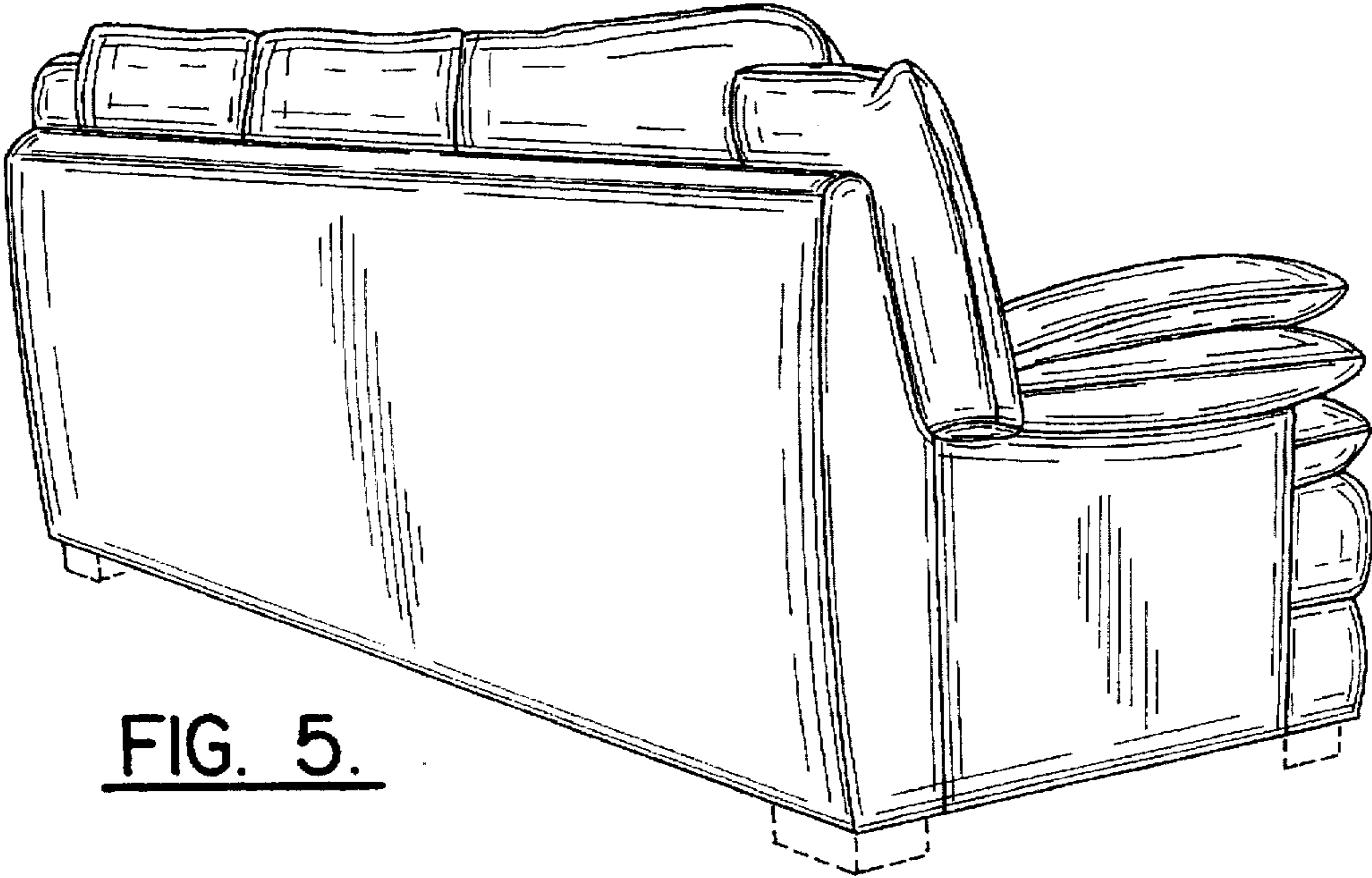

FIG. 5.

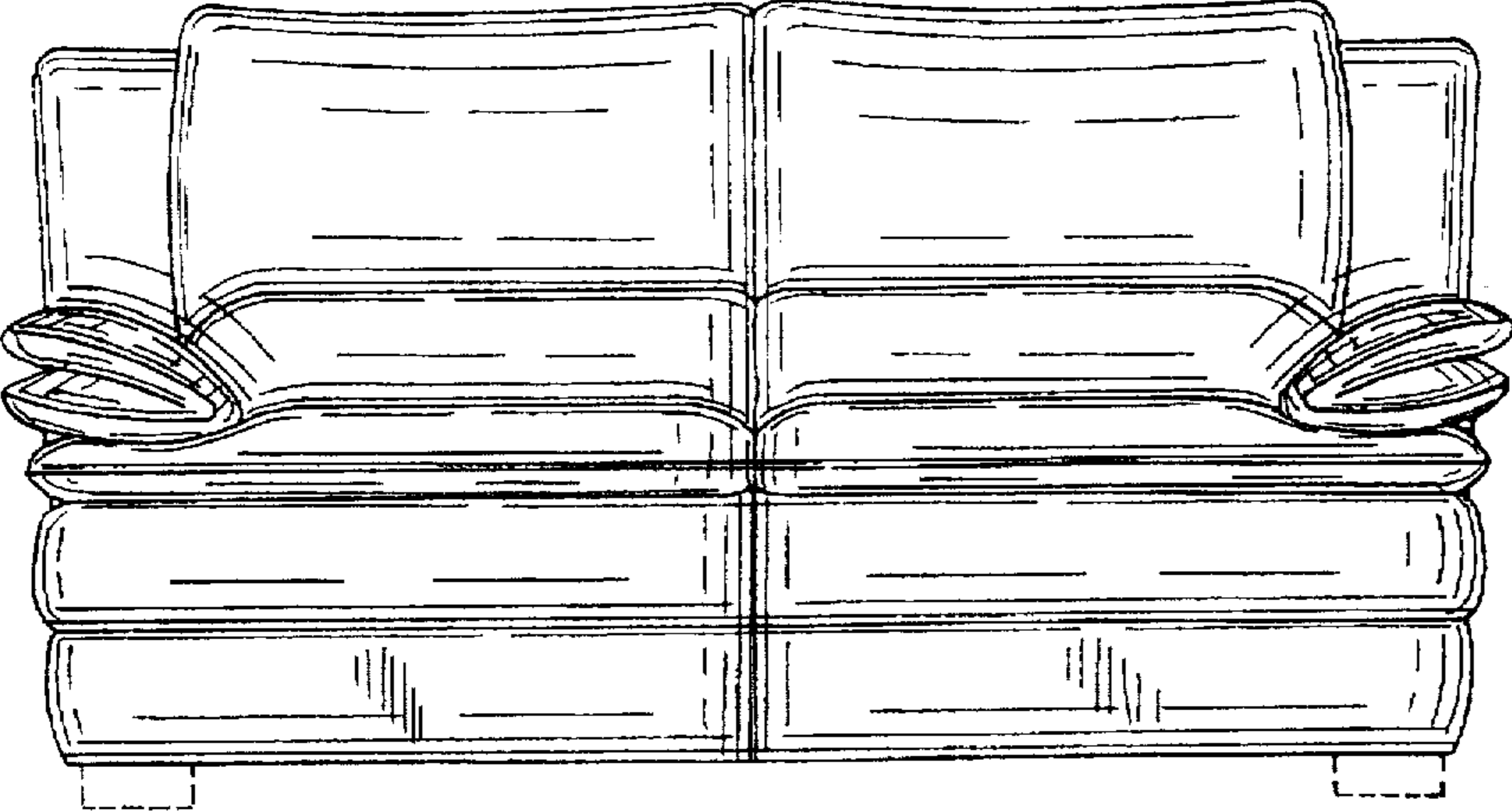

FIG. 6.

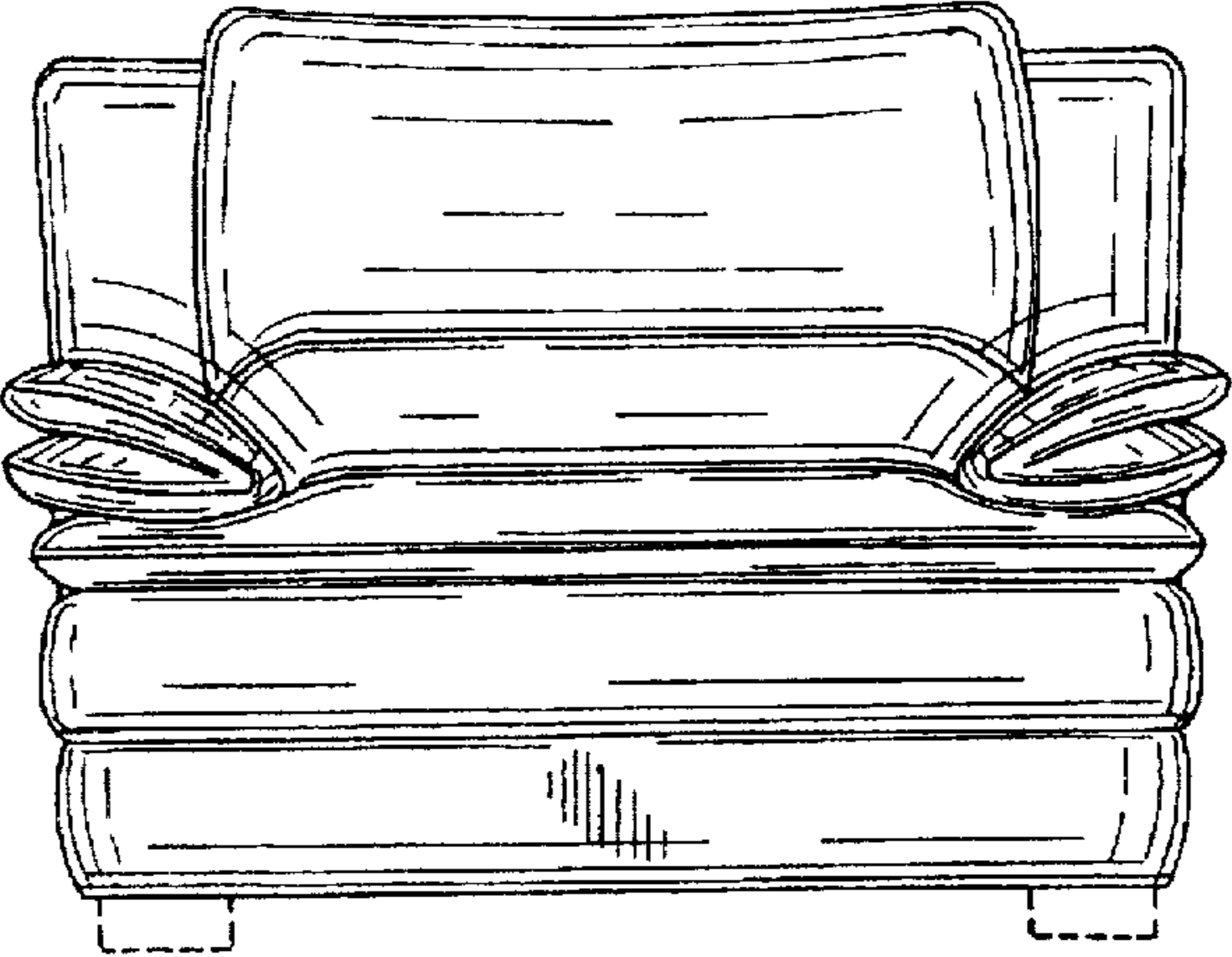

FIG. 7.