

US00D389916S

# United States Patent [19]

DiPerna et al.

[11] Patent Number: **Des. 389,916**

[45] Date of Patent: **\*\*Jan. 27, 1998**

[54] **BLOOD PROCESSING DEVICE**

5,401,237 3/1995 Tachibana et al. .... 604/4  
5,423,738 6/1995 Robinson et al. .... 604/4

[75] Inventors: **Paul M. DiPerna**, Long Grove;  
**Michael J. Scola**, Roselle; **Russell W. Wade**, Antioch; **Richard L. West**, Lake Villa; **Timothy J. Patno**, Mundelein; **William H. Cork**, Lake Bluff, all of Ill.; **Leif Huff**, Somerville, Mass.

*Primary Examiner*—Stella Reid  
*Attorney, Agent, or Firm*—Daniel D. Ryan; Denise M. Serewicz; Bradford R. L. Price

[73] Assignee: **Baxter International Inc.**, Deerfield, Ill.

[57] **CLAIM**

The ornamental design for a blood processing device, as shown.

[\*\*] Term: **14 Years**

**DESCRIPTION**

[21] Appl. No.: **49,263**

FIG. 1 is a perspective view showing the front and right side of the blood processing device, with the front drawer closed; FIG. 2 is a perspective view showing the front and right side of the blood processing device, with the front drawer opened;

[22] Filed: **Jan. 22, 1996**

[51] LOC (6) Cl. .... **24-01**

FIG. 3 is a right side elevational view of the blood processing device shown in FIG. 1;

[52] U.S. Cl. .... **D24/169**

FIG. 4 is a left side elevational view of the blood processing device shown in FIG. 1;

[58] Field of Search ..... D24/169; 604/4, 604/6, 28, 48, 49; 422/41, 48; 210/198.1, 782

FIG. 5 is a front elevational view of the blood processing device shown in FIG. 1;

[56] **References Cited**

**U.S. PATENT DOCUMENTS**

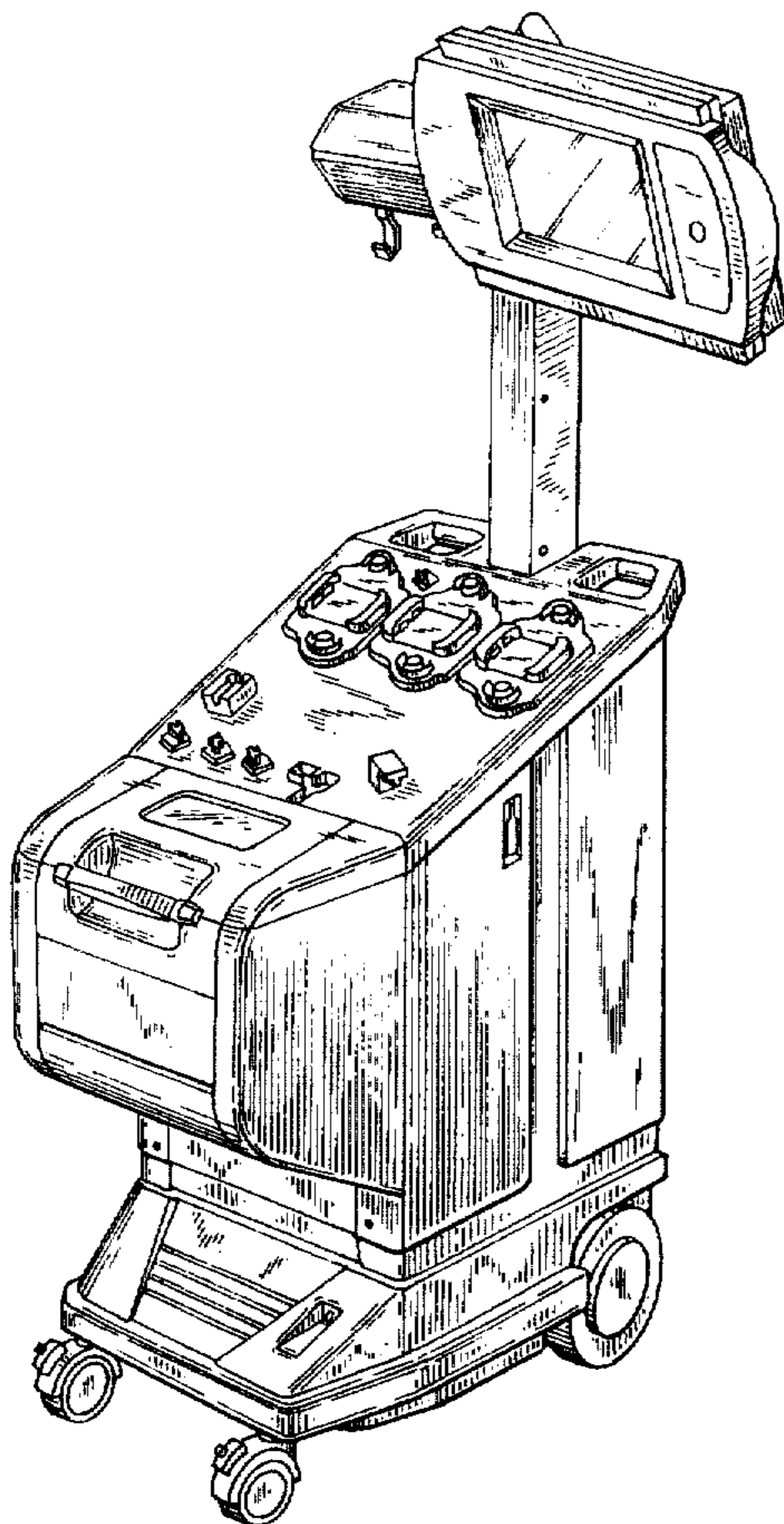
- D. 248,488 7/1978 Ashcraft et al. .... D24/169
- D. 258,909 4/1981 Bergo et al. .... D24/169
- D. 367,534 2/1996 DiPerna et al. .... D24/169
- 5,391,142 2/1995 Sites et al. .... 604/4

FIG. 6 is a rear elevational view of the blood processing device shown in FIG. 1; and,

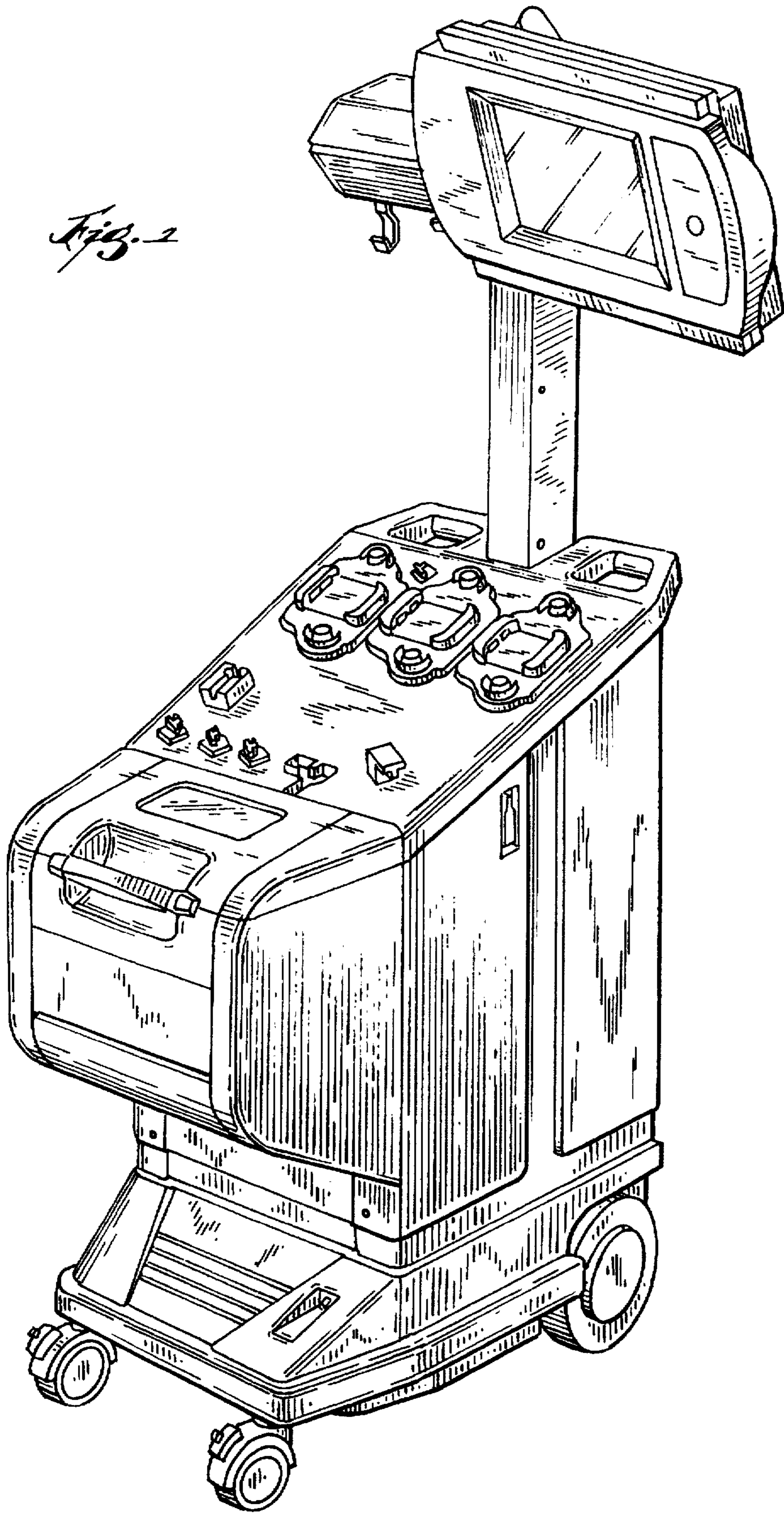
FIG. 7 is a top plan view of the blood processing device shown in FIG. 1.

The bottom of the article is plain and unornamented.

**1 Claim, 7 Drawing Sheets**

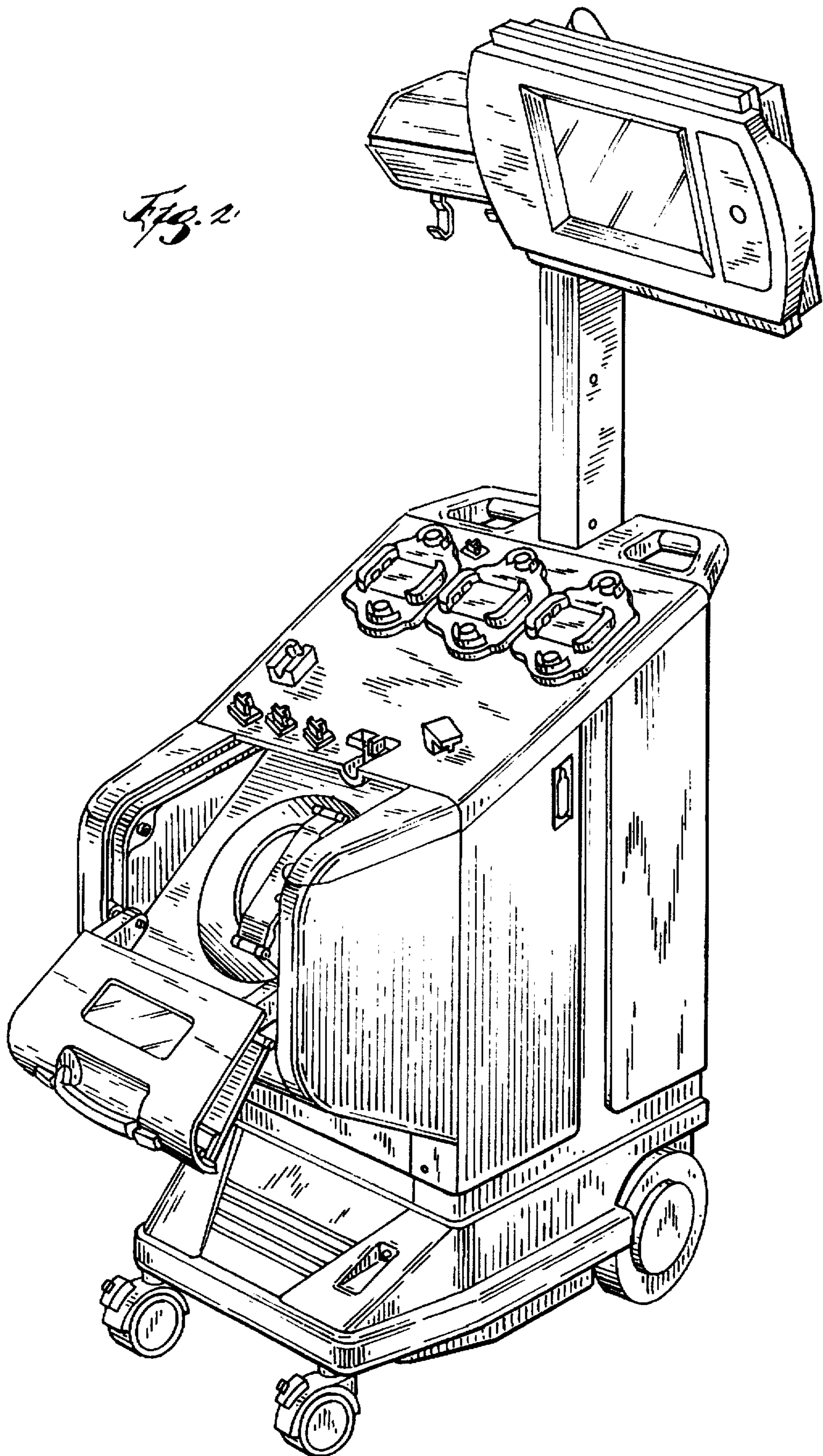


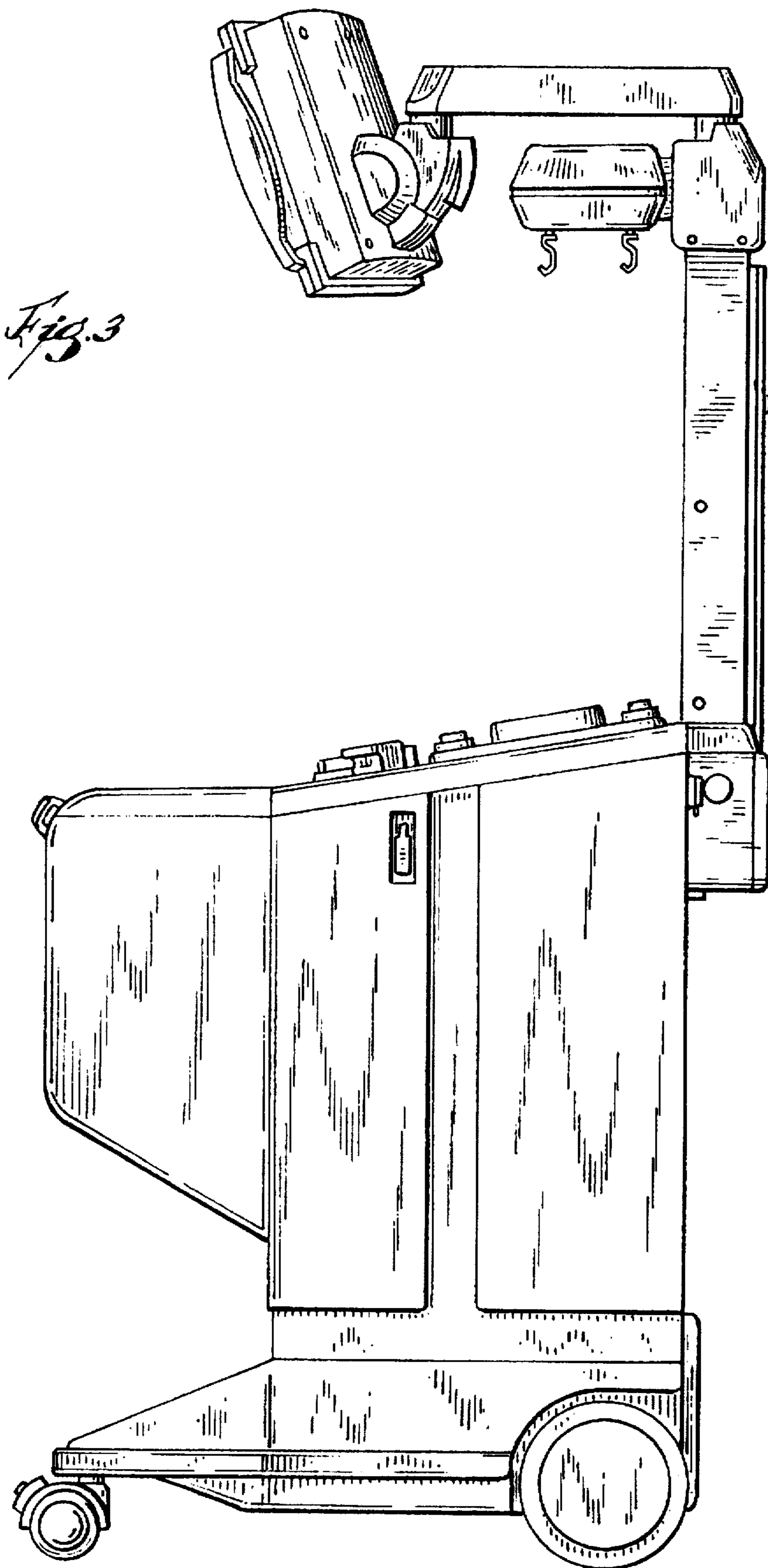
*Fig. 1*



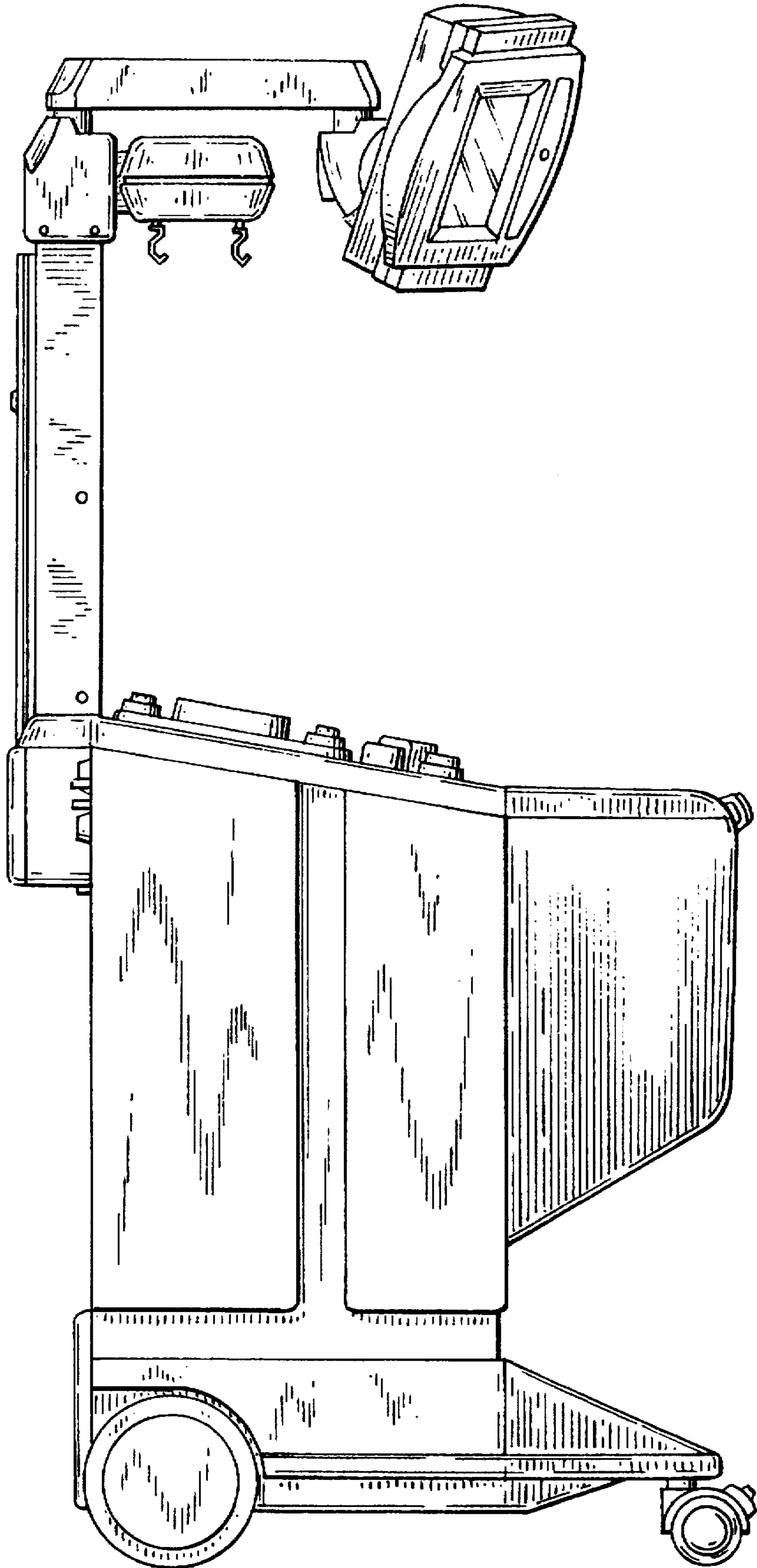


*Fig. 2*

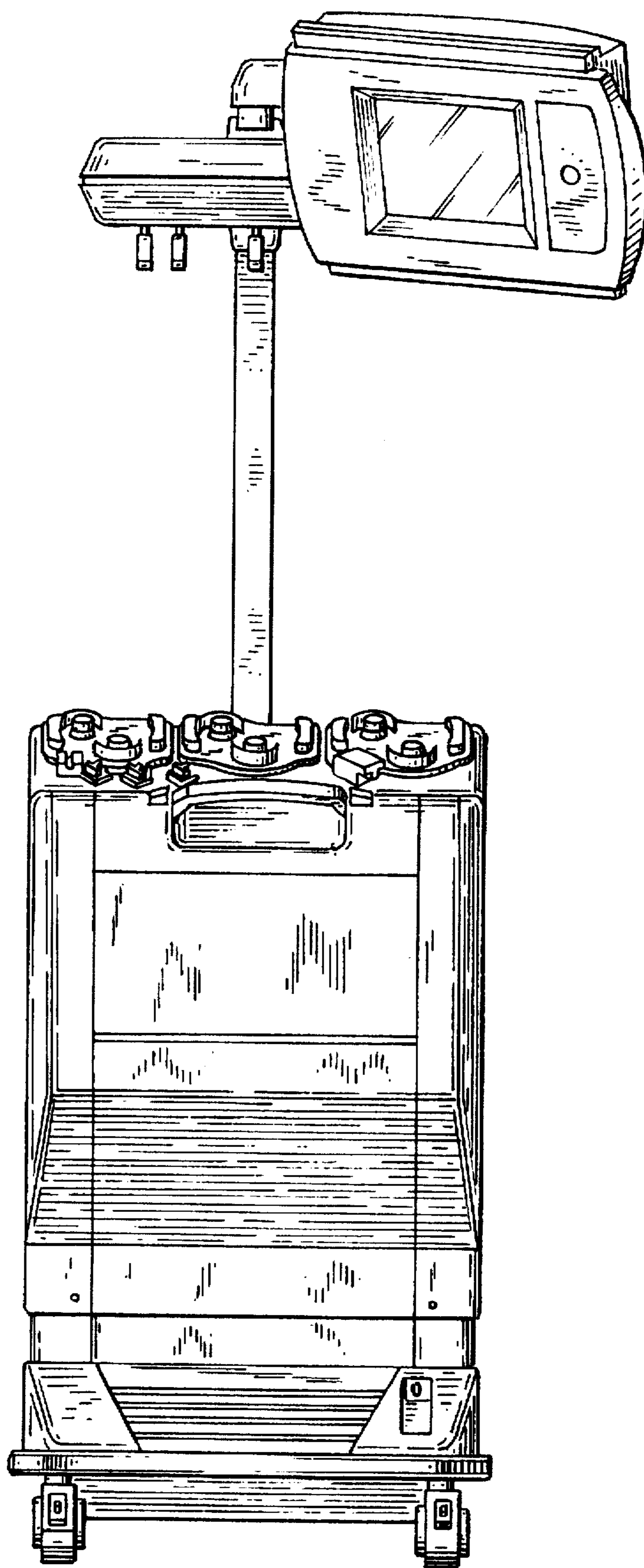




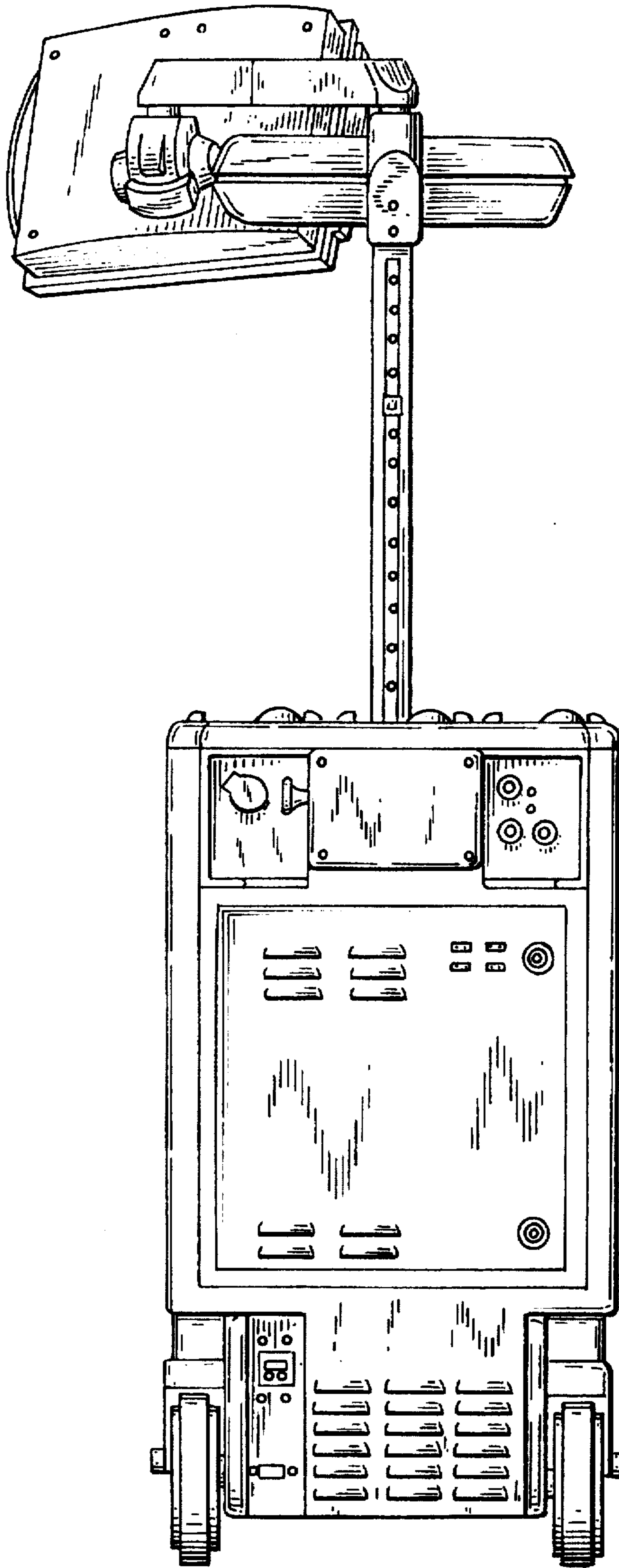
*Fig. 4*



*Fig. 5*







*Fig. 6*

*Fig. 1*

