



US00D389659S

United States Patent [19]
Hummel

[11] **Patent Number:** **Des. 389,659**
[45] **Date of Patent:** ****Jan. 27, 1998**

[54] **CHAIR**

[76] **Inventor:** **Robert D. Hummel**, 10203 Aqua Azul Ct., Austin, Tex. 78733

[**] **Term:** **14 Years**

[21] **Appl. No.:** **62,389**

[22] **Filed:** **Nov. 4, 1996**

[51] **LOC (6) Cl.** **06-01**

[52] **U.S. Cl.** **D6/349; D6/482; D6/484**

[58] **Field of Search** **D6/349, 334, 355, D6/480-489; 297/461, 462; 108/150, 153**

[56] **References Cited**

U.S. PATENT DOCUMENTS

D. 178,425 7/1956 Pollard D6/486 X
D. 341,507 11/1993 Harvey et al. D6/482

OTHER PUBLICATIONS

DIA, #403 tables.
DIA, table at left, #179-3.
Carsons, table set in rear at right.

Primary Examiner—Janice E. Seeger

Attorney, Agent, or Firm—Shaffer & Culbertson; J. Nevin Shaffer, Jr.

[57] **CLAIM**

The ornamental design for a chair, as shown and described.

DESCRIPTION

FIG. 1 is a perspective view of the chair showing my new design;

FIG. 2 is a top elevational view of the chair design of FIG. 1;

FIG. 3 is a bottom elevational view of the chair design of FIG. 1;

FIG. 4 is a front elevational view of the chair design of FIG. 1;

FIG. 5 is one side elevational view of the chair design of FIG. 1;

FIG. 6 is a back elevational view of the chair design of FIG. 1;

FIG. 7 is the other side elevational view of the chair design of FIG. 1; and,

FIG. 8 is a perspective view of four chairs of my design grouped together, the broken lines are for environmental purposes only and form no part of the claimed design.

1 Claim, 3 Drawing Sheets

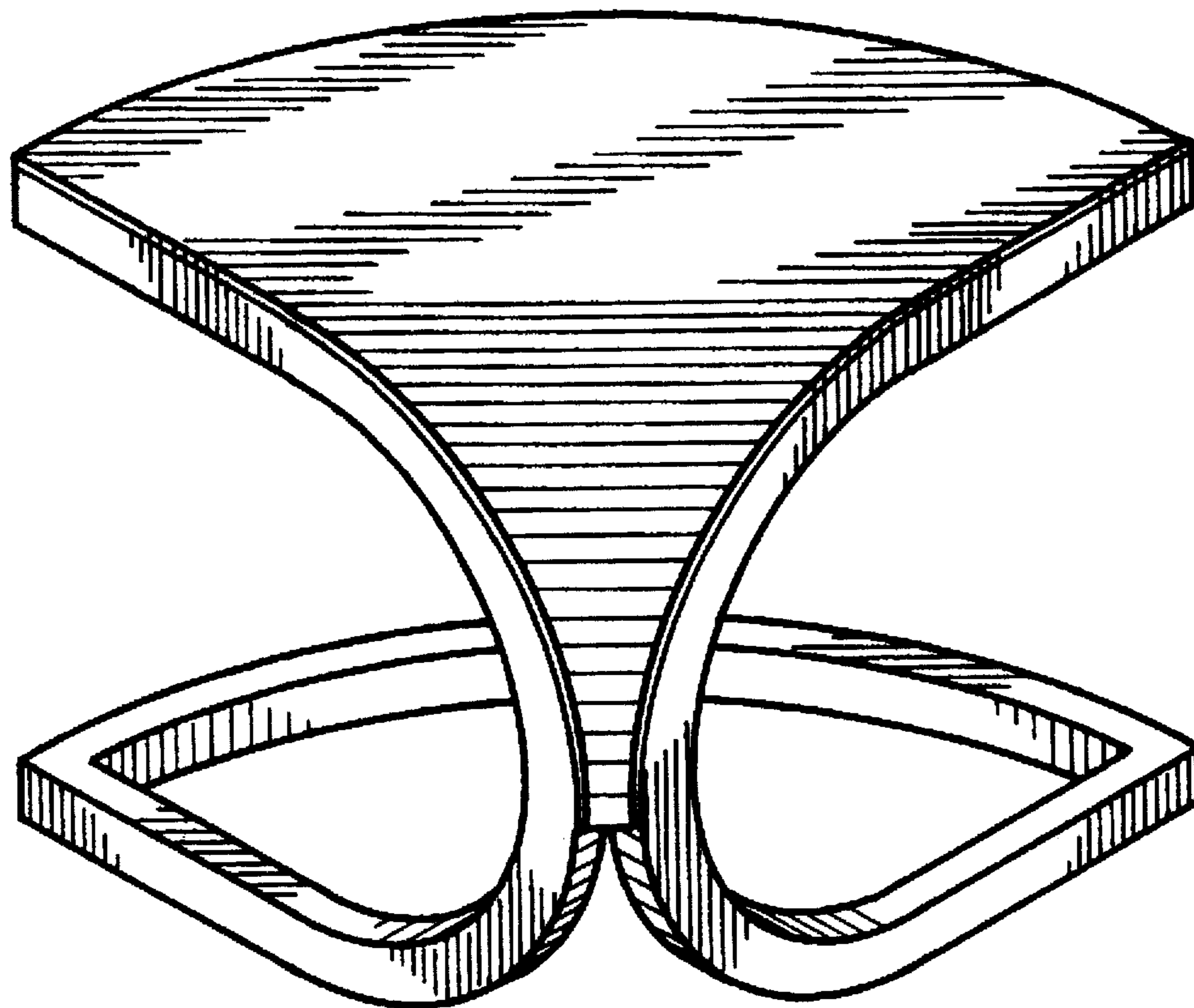

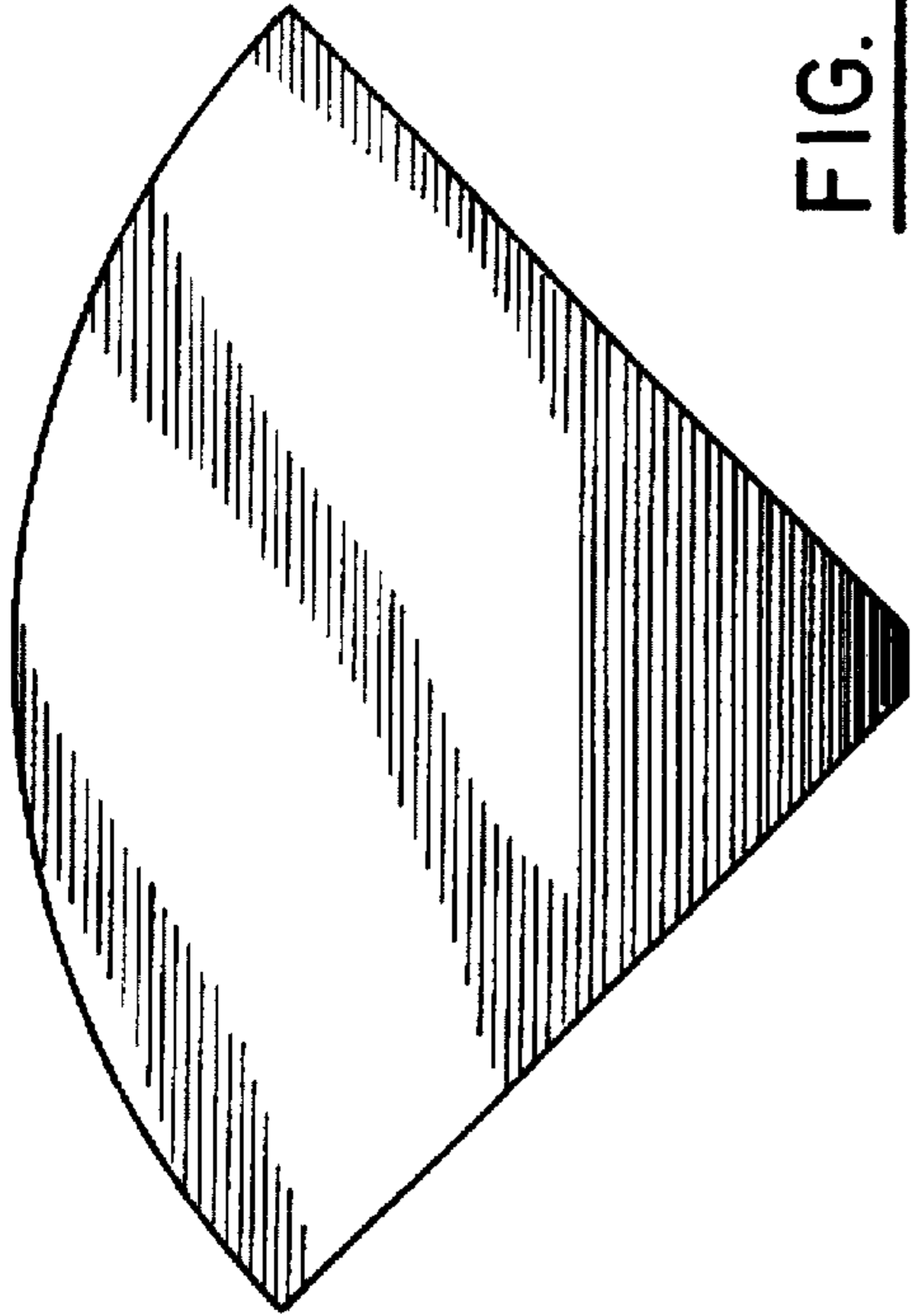

FIG. 2

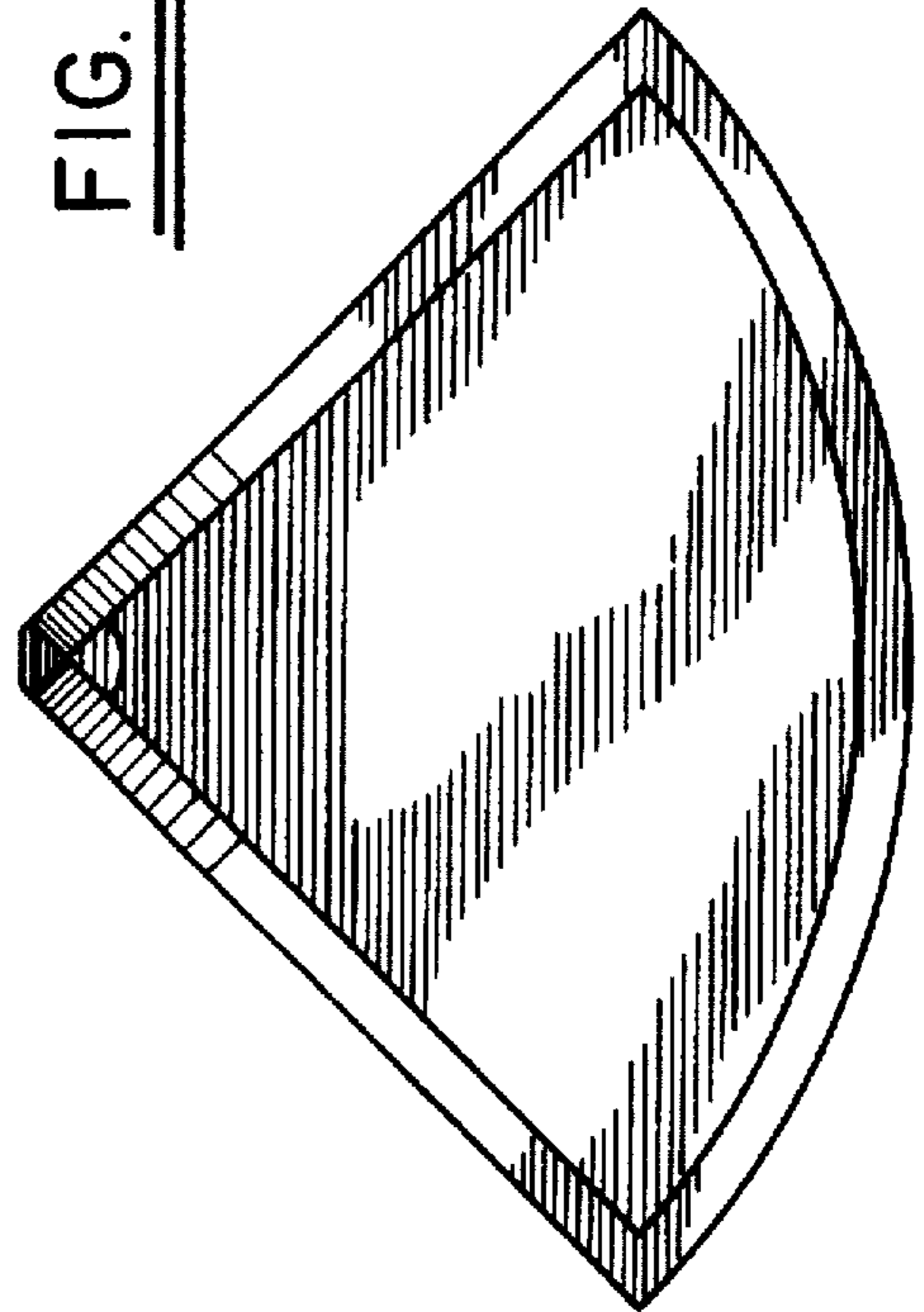

FIG. 3

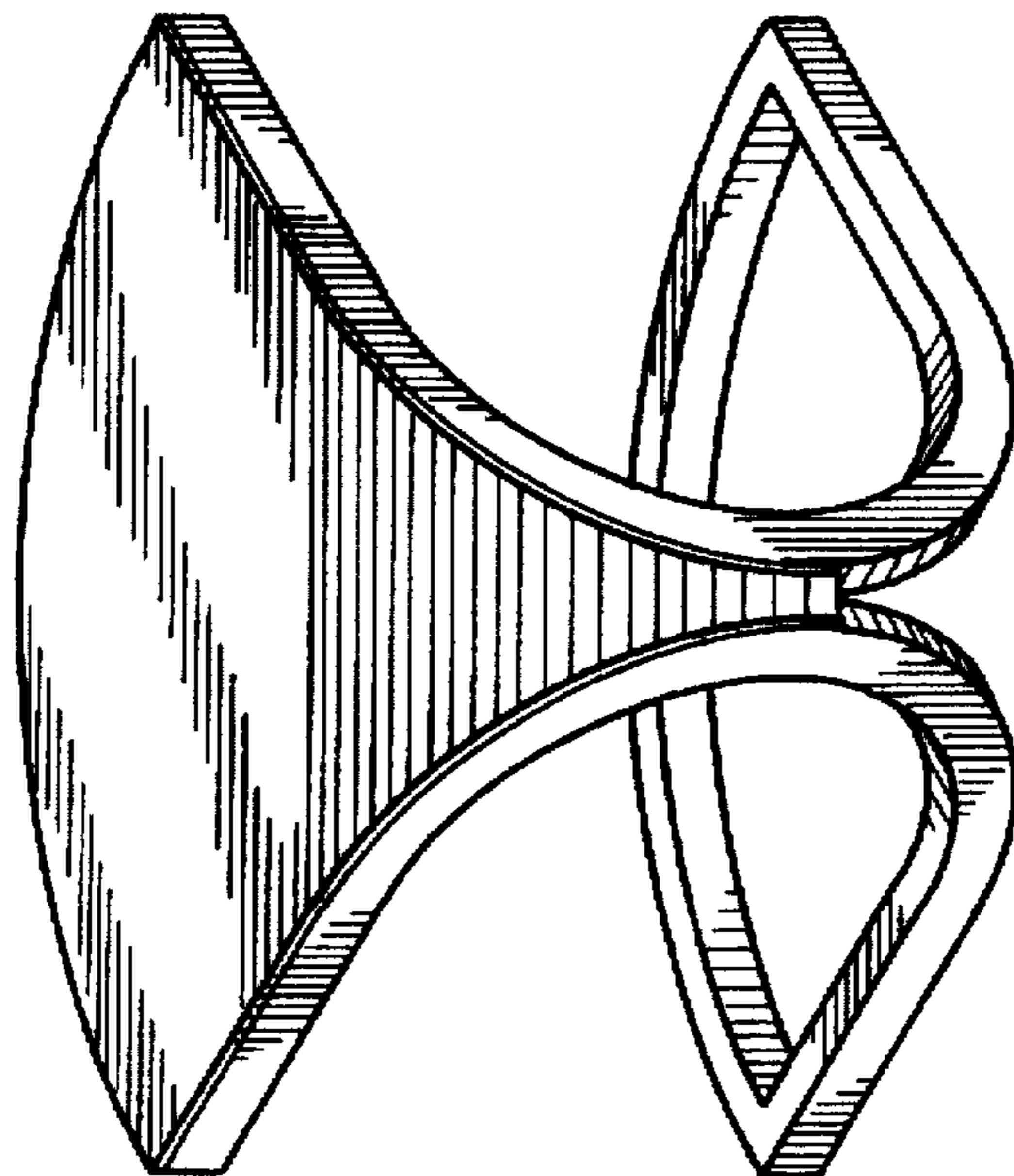

FIG. 1

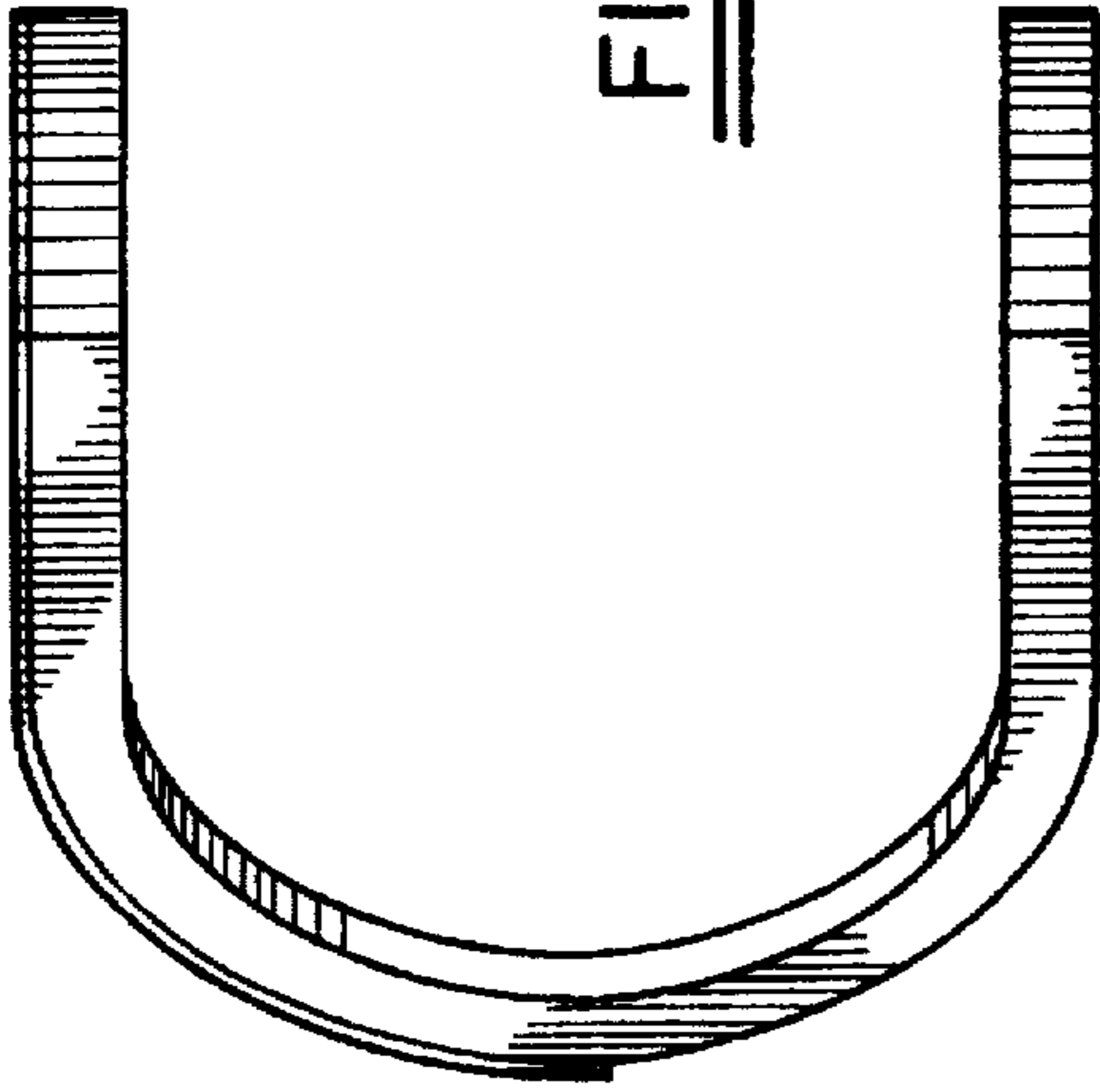

FIG. 5

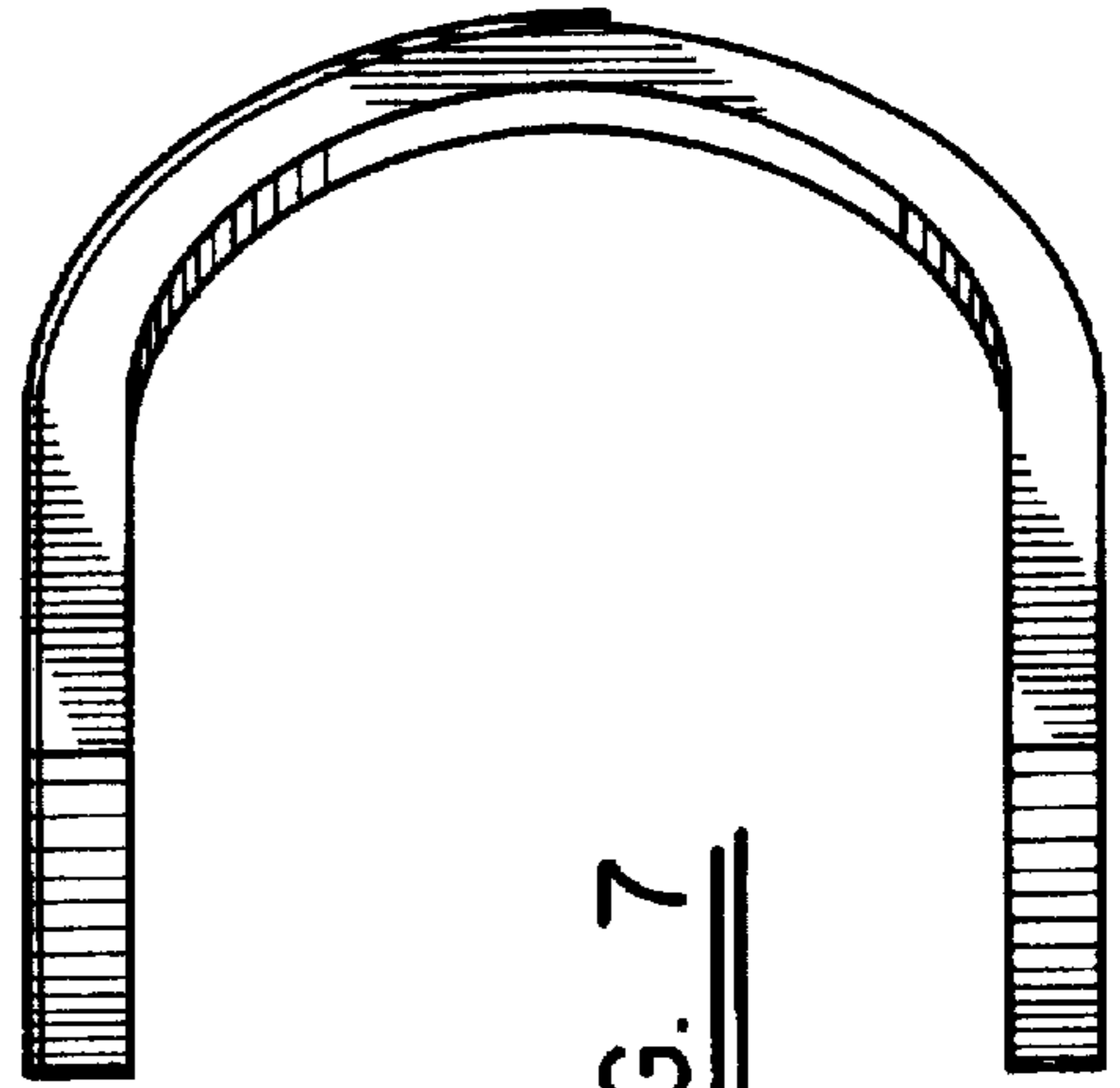

FIG. 7

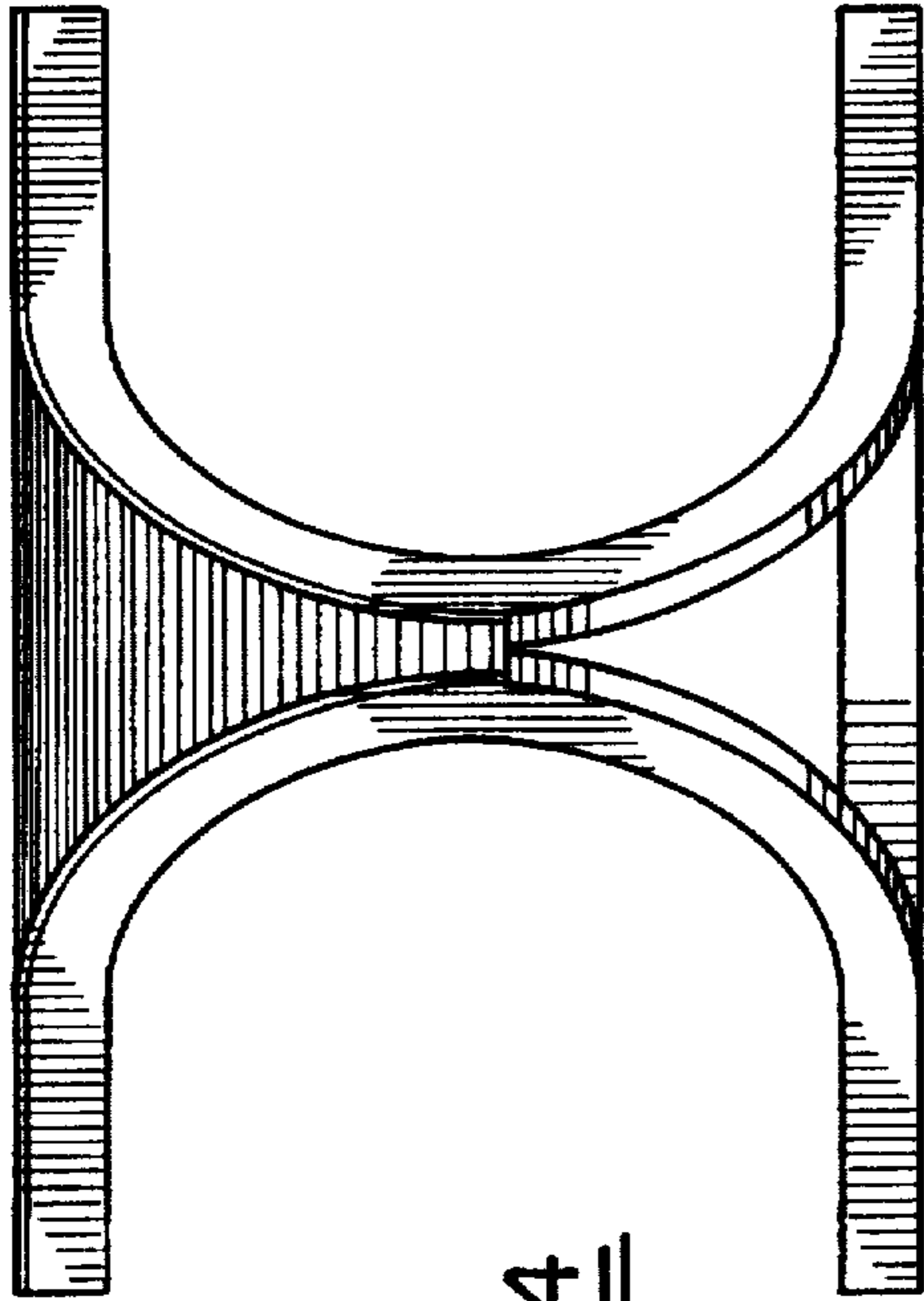

FIG. 4

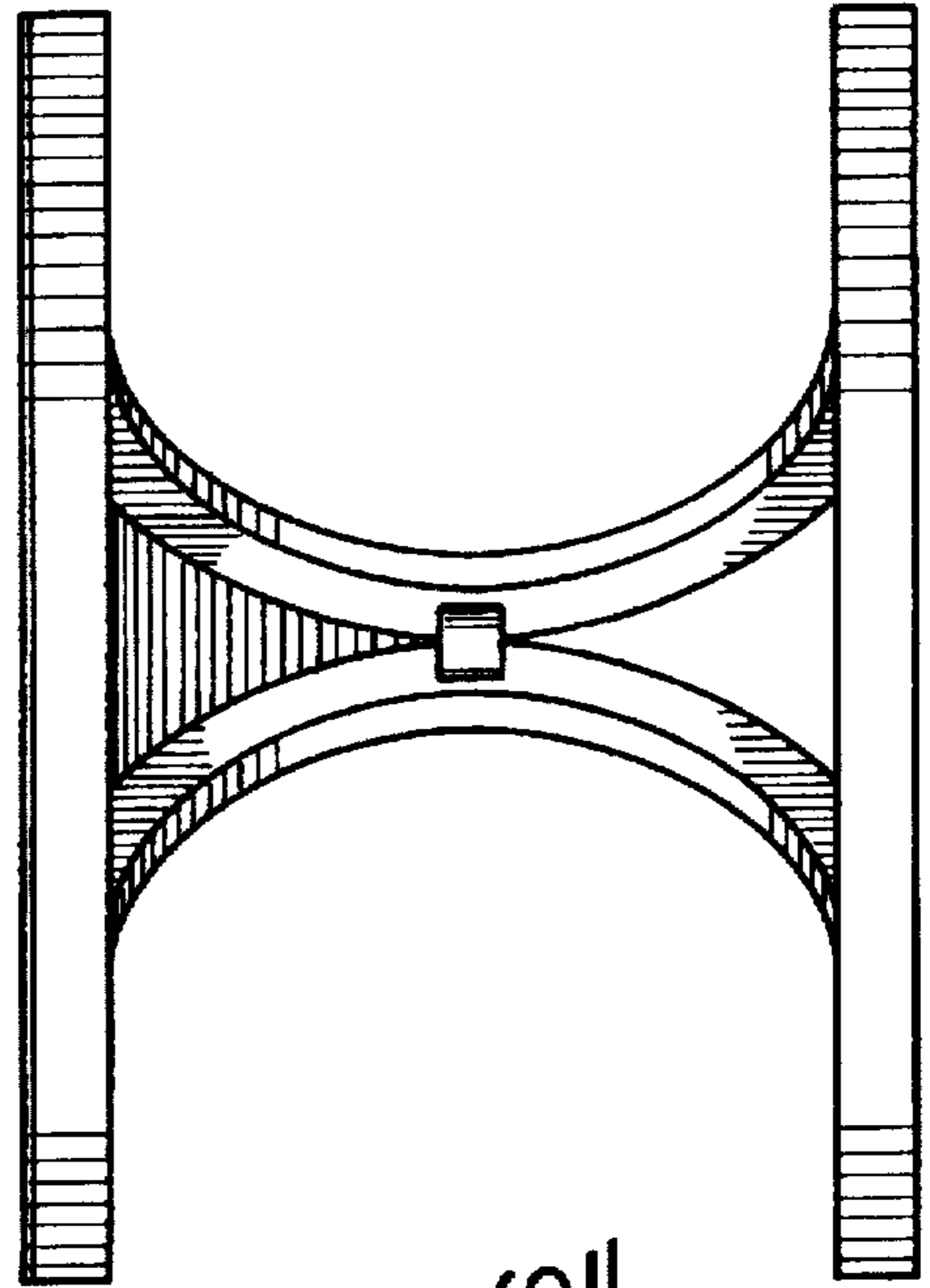

FIG. 6

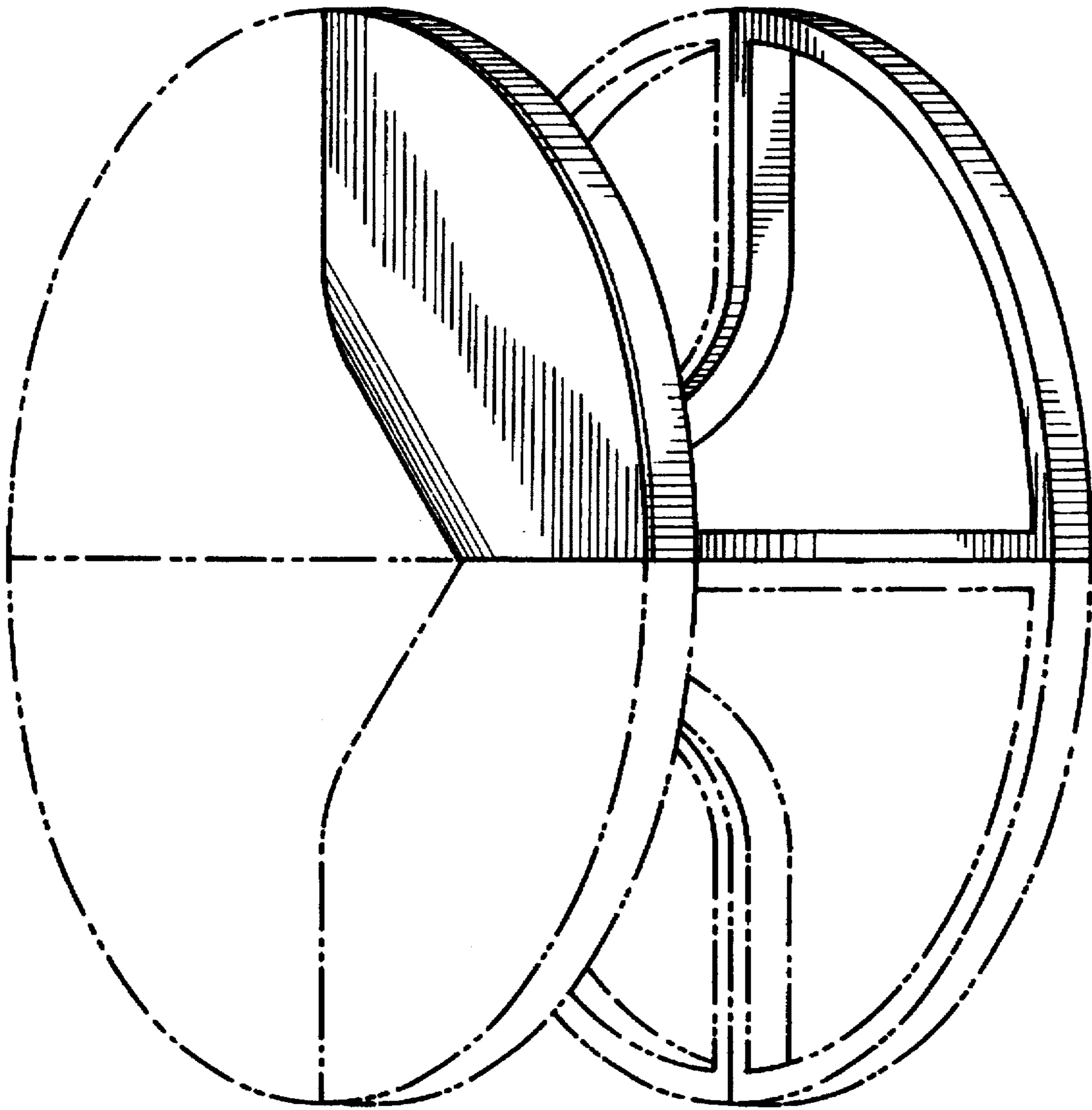

FIG. 8