

US00D389591S

United States Patent [19]

[11] Patent Number: **Des. 389,591**

Blackman et al.

[45] Date of Patent: ****Jan. 20, 1998**

[54] **FLUORESCENT NIGHT LIGHT**

5,420,764 5/1995 Hussain et al. 362/226 X

[76] Inventors: **Stephen Blackman**, 40 Raven Dr.,
Mooris Township, N.J. 07960; **Syed M. Afzal Hussain**, 2625 Blaze Trail,
Diamond Bar, Calif. 91765

Primary Examiner—Susan J. Lucas
Attorney, Agent, or Firm—Morton J. Rosenberg; David I. Klein

[**] Term: **14 Years**

[57] **CLAIM**

The ornamental design for a fluorescent night light, as shown and described.

[21] Appl. No.: **66,362**

DESCRIPTION

[22] Filed: **Feb. 7, 1997**

[51] LOC (6) Cl. **26-05**

FIG. 1 is a perspective view of a fluorescent night light, showing our new design;

[52] U.S. Cl. **D26/26**

FIG. 2 is a front elevational view thereof;

[58] Field of Search **D26/26, 75, 76;**

FIG. 3 is a rear elevational view thereof;

362/147, 432, 226, 222, 223

FIG. 4 is a bottom plan view thereof;

FIG. 5 is a top plan view thereof; and,

FIG. 6 is a side view thereof, the opposite side being a mirror image.

[56] **References Cited**

U.S. PATENT DOCUMENTS

- D. 301,750 6/1989 Fenne D26/26
- D. 347,703 6/1994 Ham D26/26

1 Claim, 3 Drawing Sheets

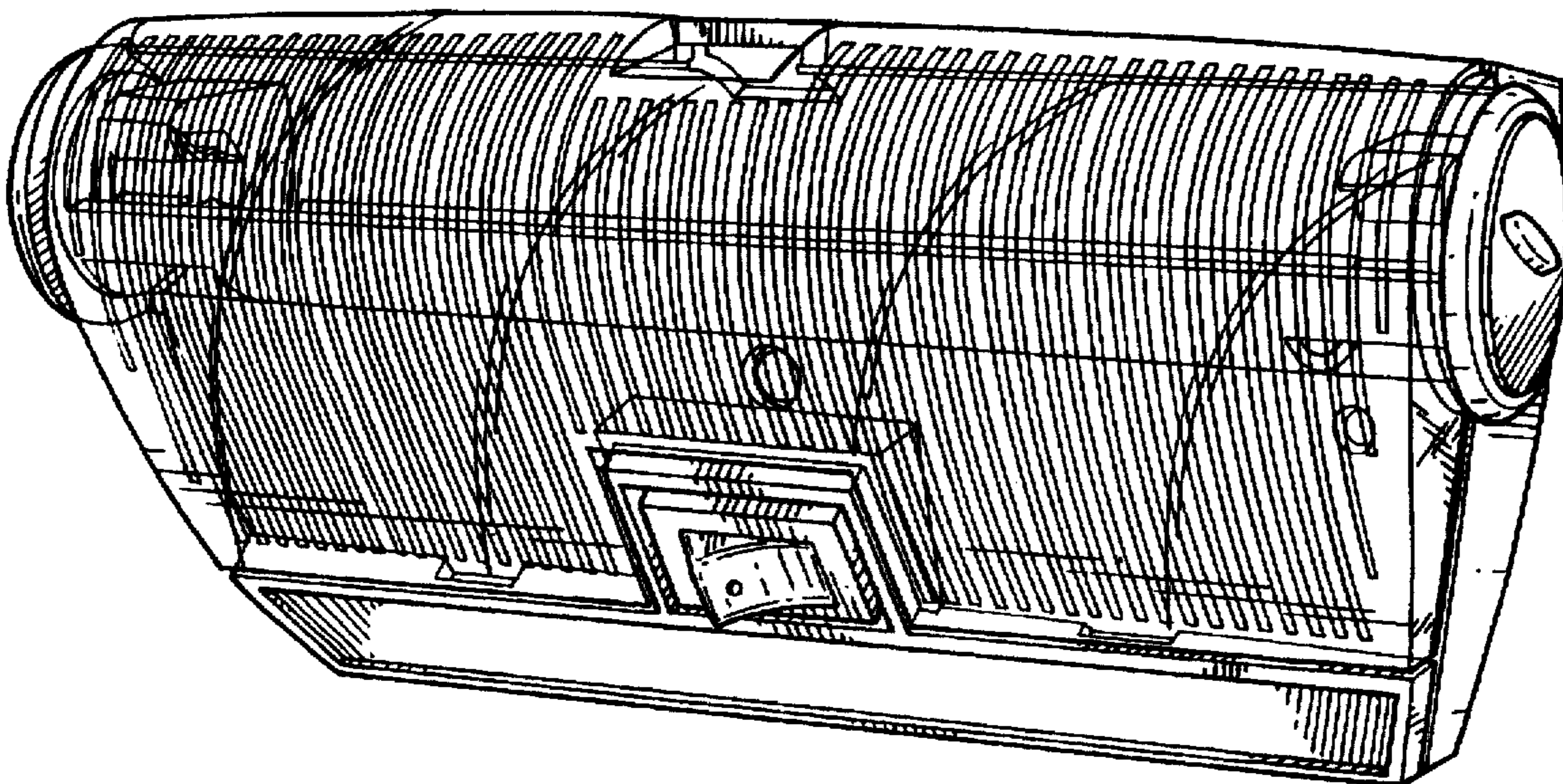

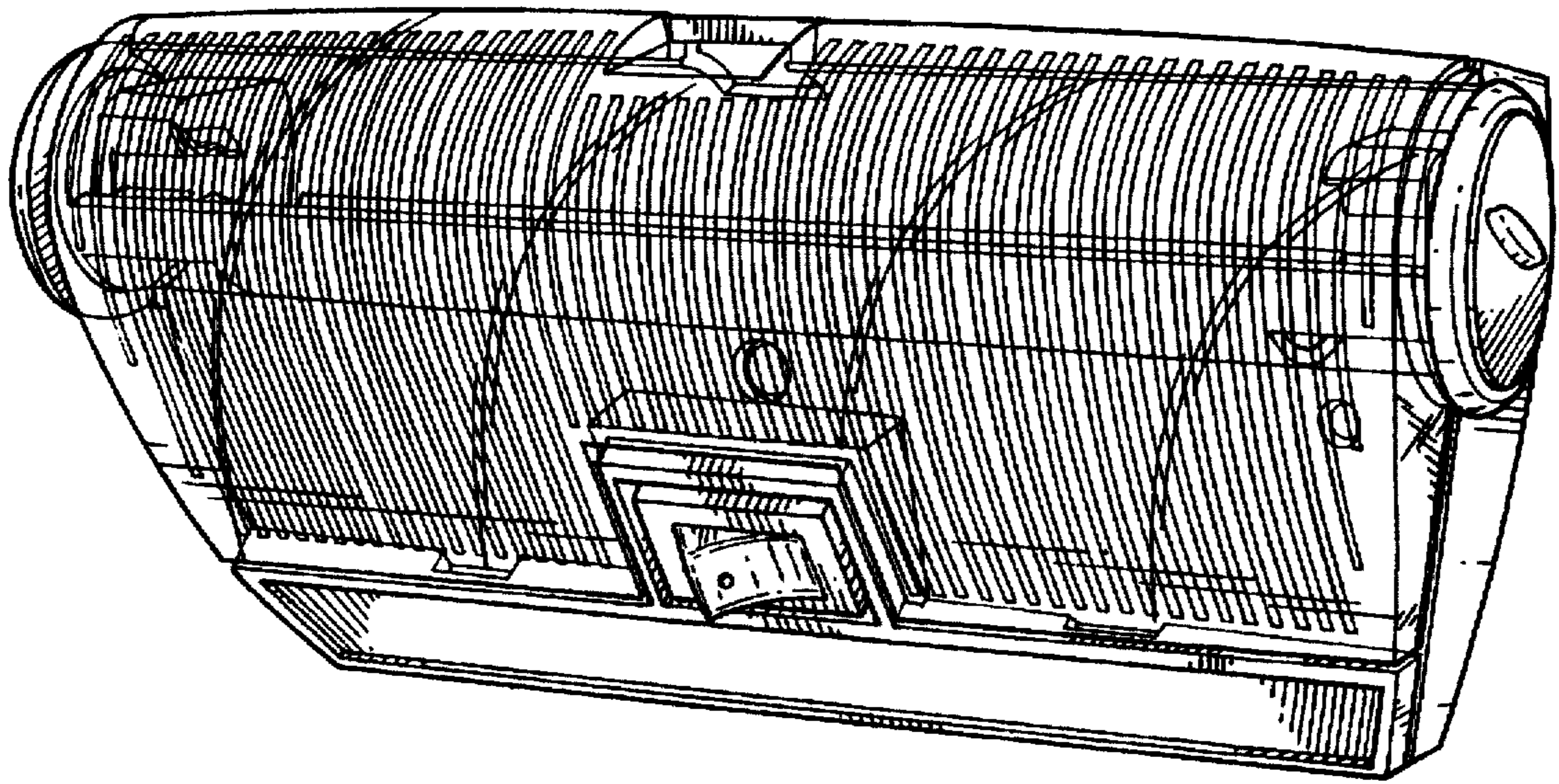

FIG. 1

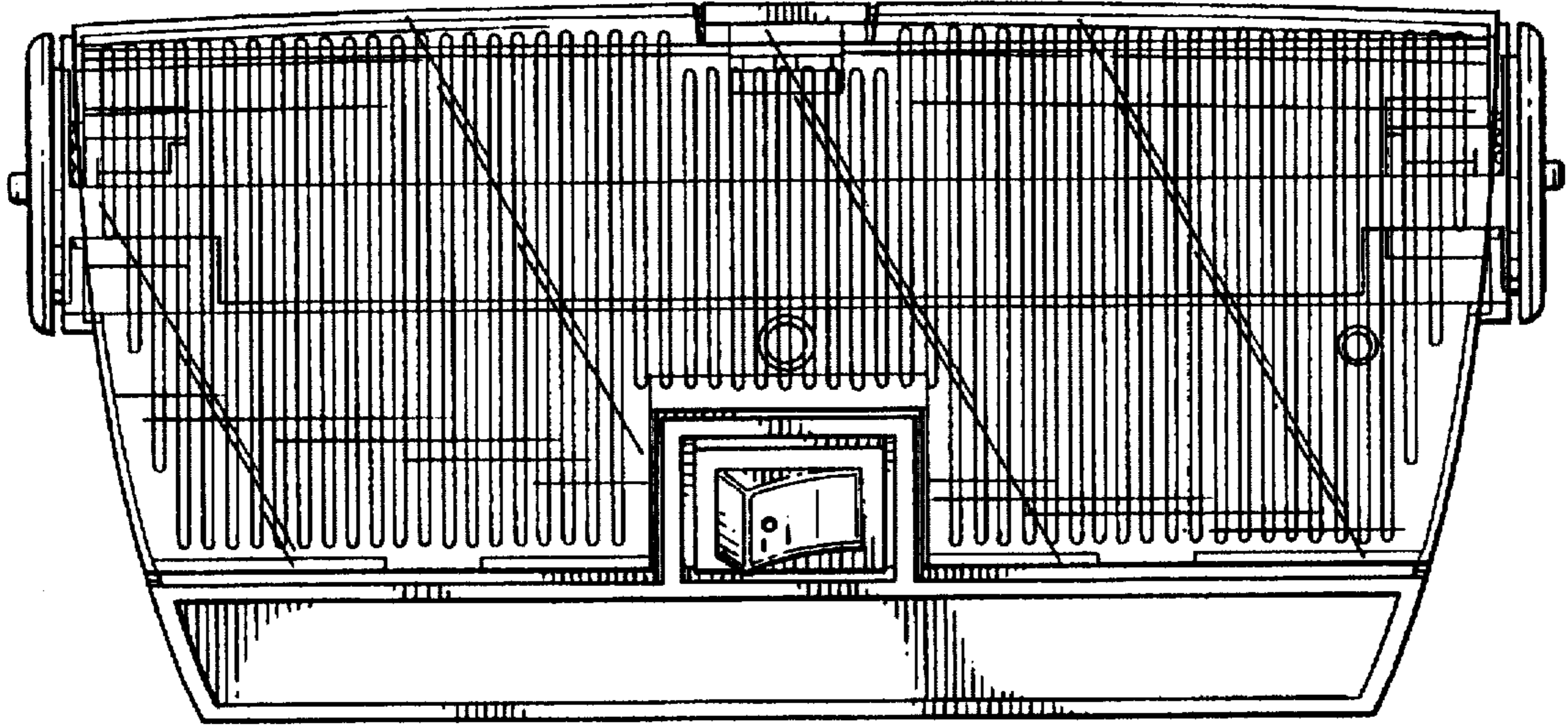

FIG. 2

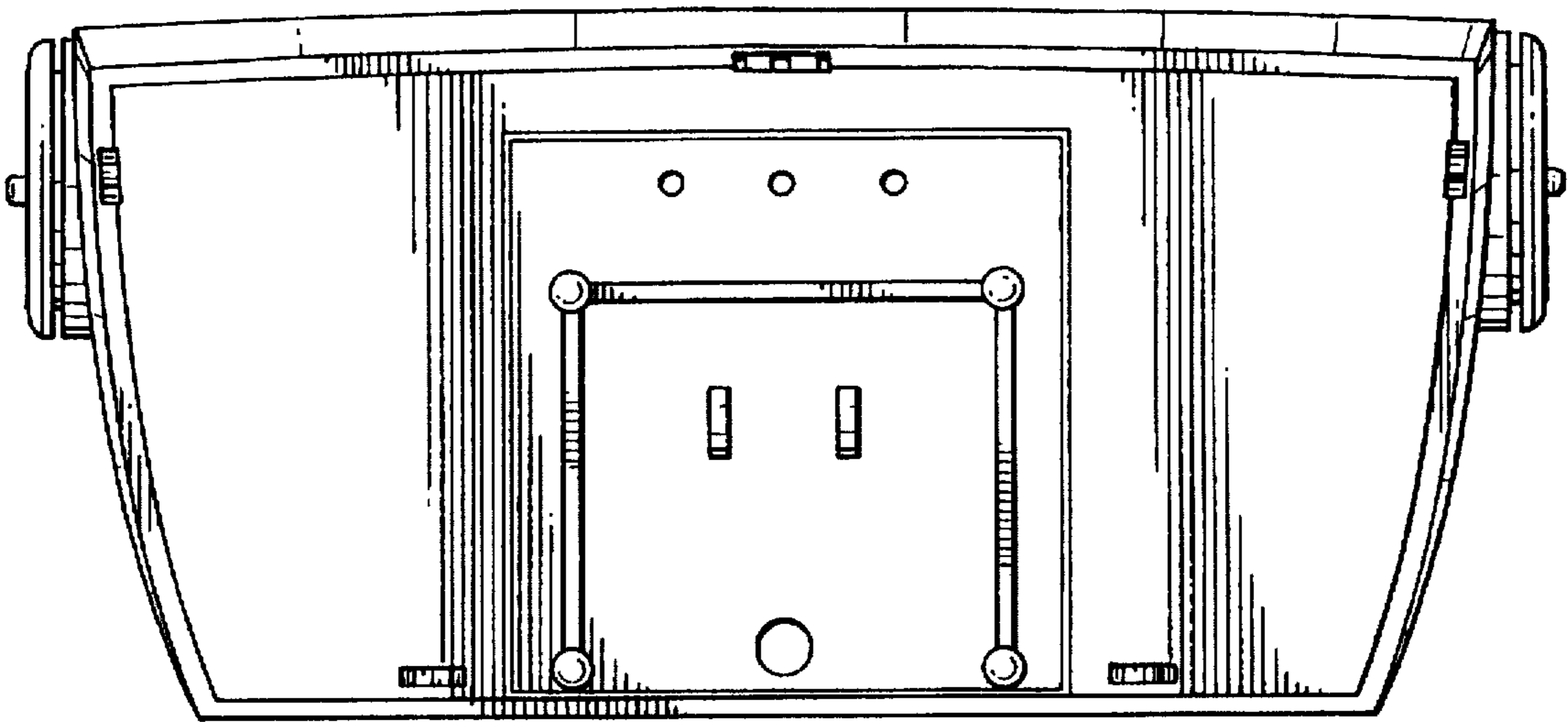

FIG. 3

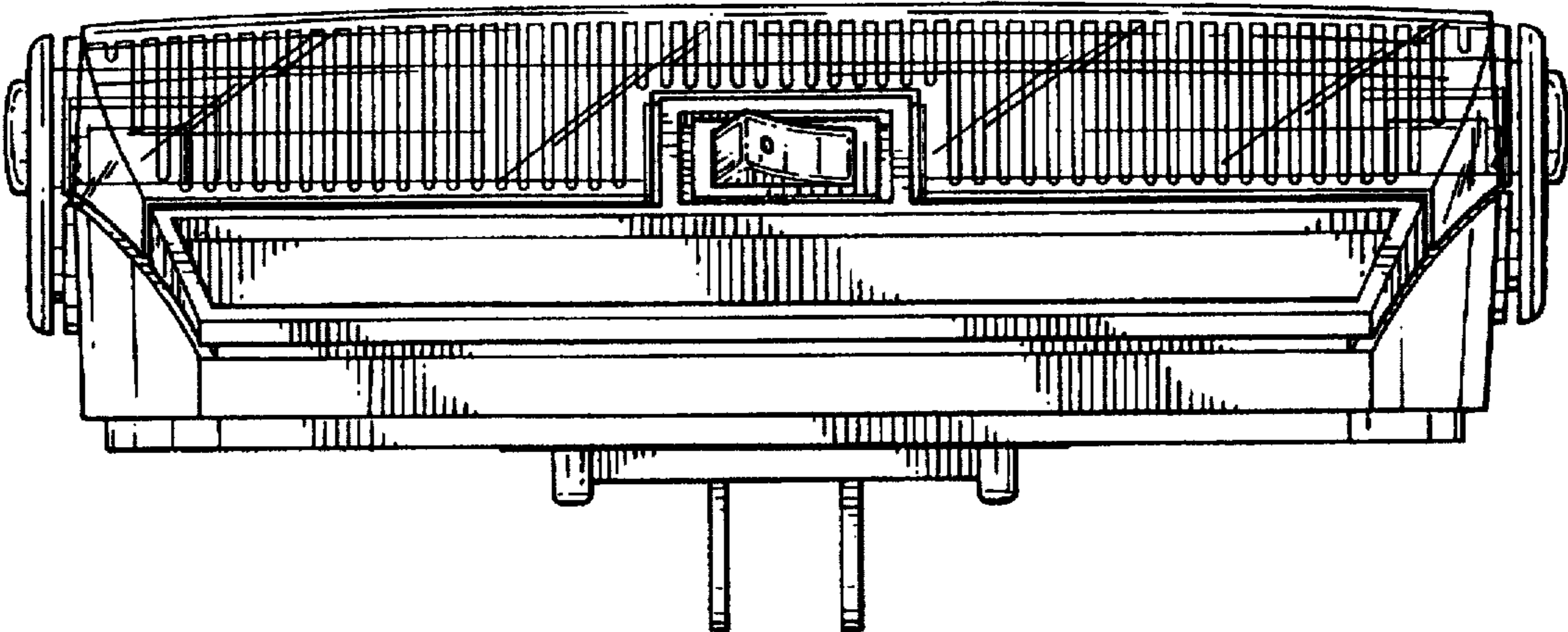

FIG. 4

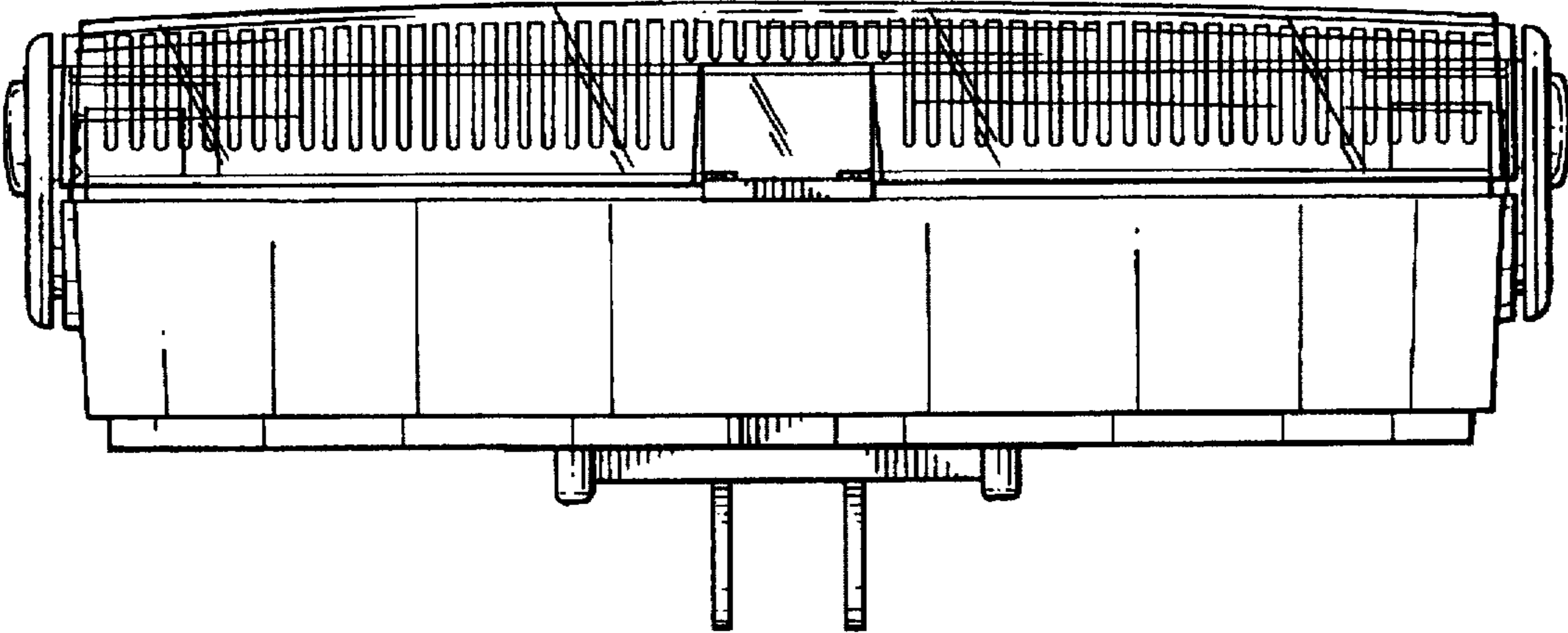

FIG. 5

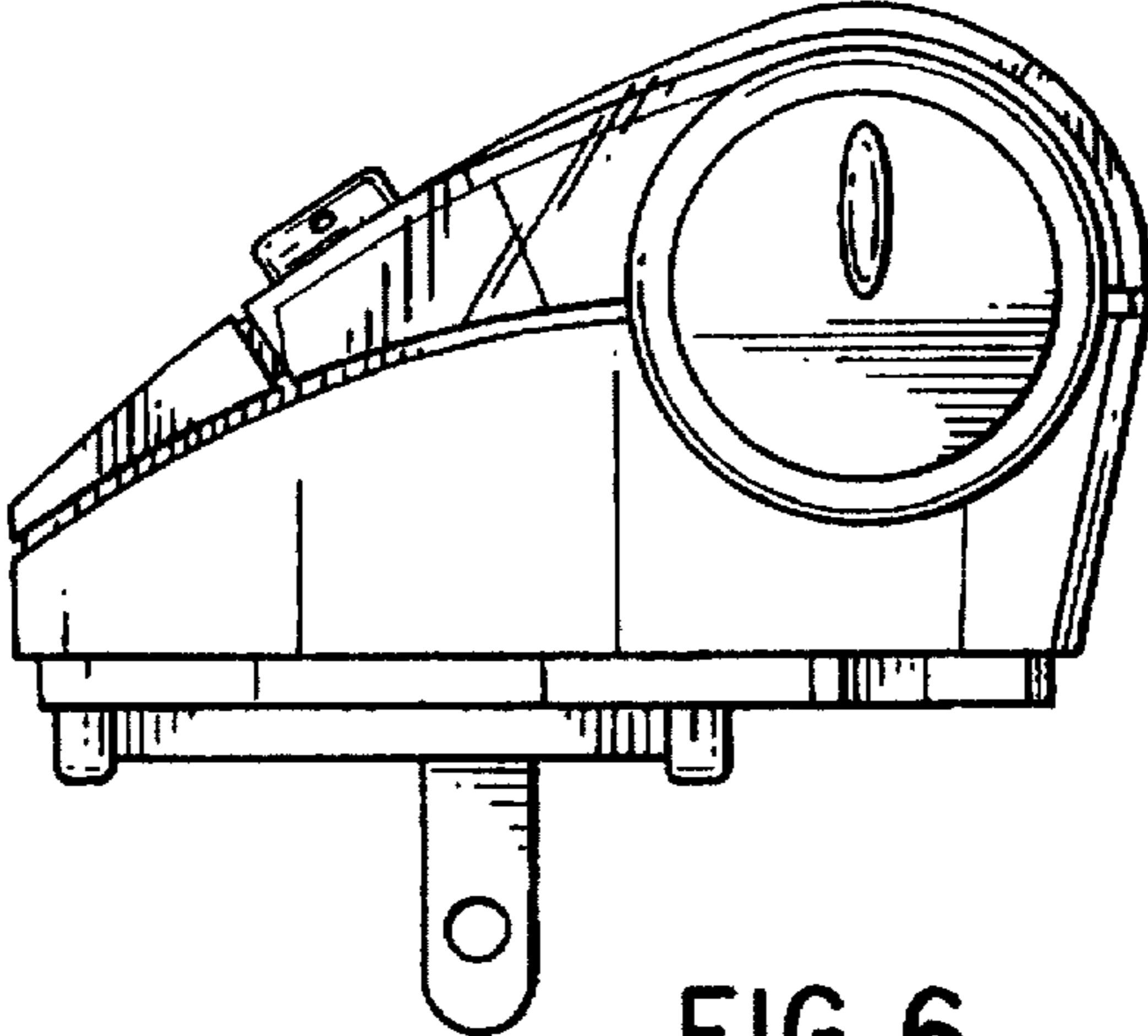

FIG. 6