



US00D389575S

United States Patent [19]
Grasfield et al.

[11] **Patent Number: Des. 389,575**
[45] **Date of Patent: **Jan. 20, 1998**

[54] **CHESTPIECE OF A STETHOSCOPE**

4,903,794 2/1990 Klippert et al. 181/131
5,514,840 5/1996 Selinger 181/131

[76] Inventors: **James A. Grasfield**, 235 Moose Hill Pkwy., Sharon, Mass. 02067; **David E. Winston**, 7 Wainwright Rd. #15, Winchester, Mass. 01890; **Peter R. H. Stark**; **Daniela Steinhubel**, both of 41 Bonad Rd., Stoneham, Mass. 02180

FOREIGN PATENT DOCUMENTS

0 454 931 11/1991 European Pat. Off. A61B 7/04

[**] Term: **14 Years**

Primary Examiner—Louis S. Zarfaz
Assistant Examiner—Frank Martinez
Attorney, Agent, or Firm—Wolf, Greenfield & Sacks, P.C.; James H. Morris

[21] Appl. No.: **61,328**

[57] **CLAIM**

[22] Filed: **Oct. 22, 1996**

The ornamental design for a chestpiece of a stethoscope, as shown and described.

[51] **LOC (6) Cl.** **24-02**

DESCRIPTION

[52] **U.S. Cl.** **D24/134**

[58] **Field of Search** D24/134; 181/126, 181/131, 133; 381/67

FIG. 1 is top view, at a reduced scale, showing our new design for a chestpiece of a stethoscope;
FIG. 2 is a front plan view thereof;
FIG. 3 is an right side view thereof, the opposite side being a mirror image thereto;
FIG. 4 is a rear view thereof;
FIG. 5 is a top plan view thereof; and,
FIG. 6 is a bottom plan view thereof.

[56] **References Cited**

U.S. PATENT DOCUMENTS

D. 214,002 4/1969 Machlup et al. D24/134
D. 277,890 3/1985 Loughridge et al. D24/134
D. 346,973 5/1994 Moore et al. D24/134 X
3,182,129 5/1965 Clark et al. 179/1
3,224,526 12/1965 Weber D24/134 X
4,254,302 3/1981 Walshe 173/1 ST
4,534,058 8/1985 Hower 381/67

The broken line showing of a stethoscope is for illustrative purposes only and forms no part of the claimed design.

1 Claim, 1 Drawing Sheet

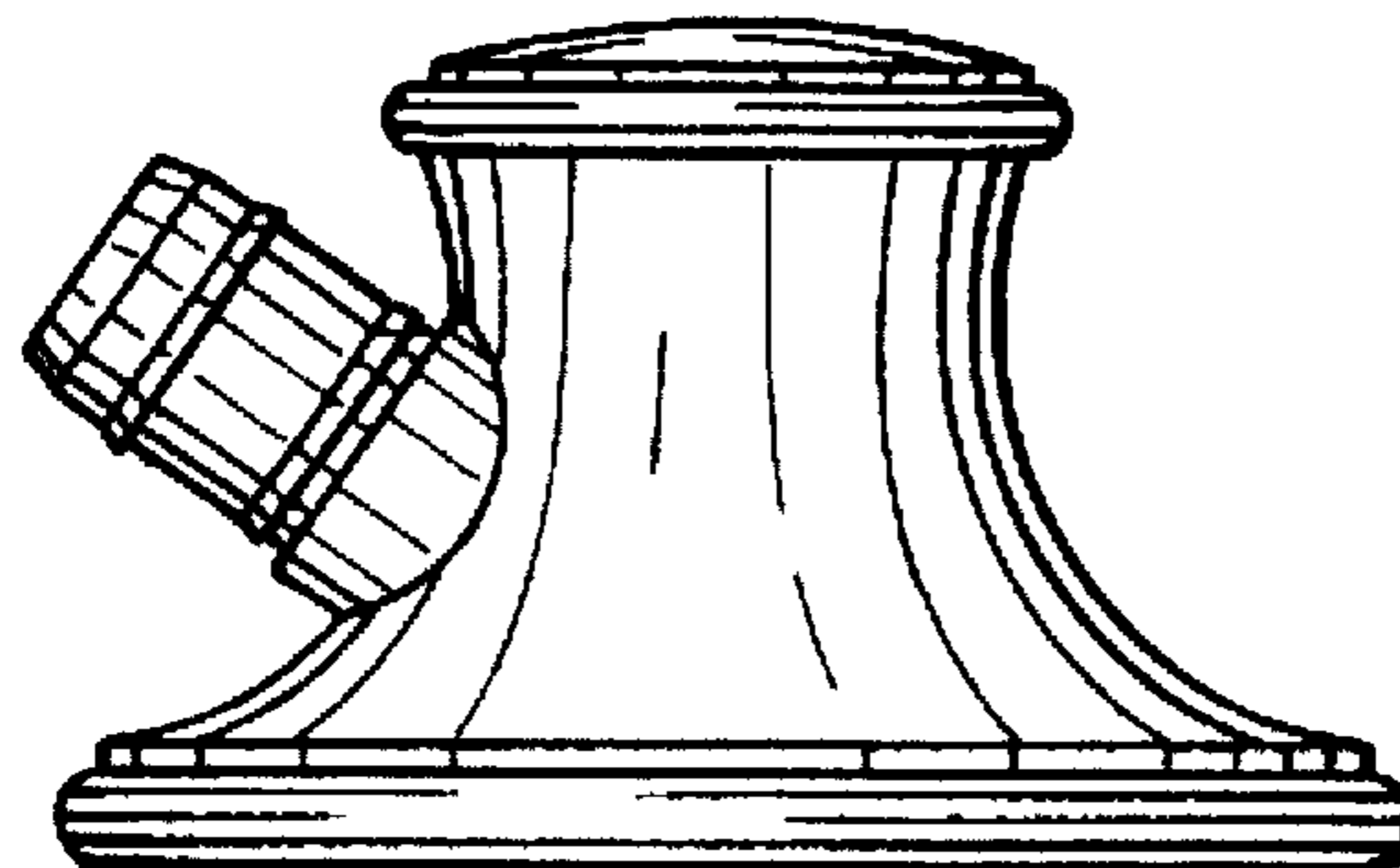

Fig. 1

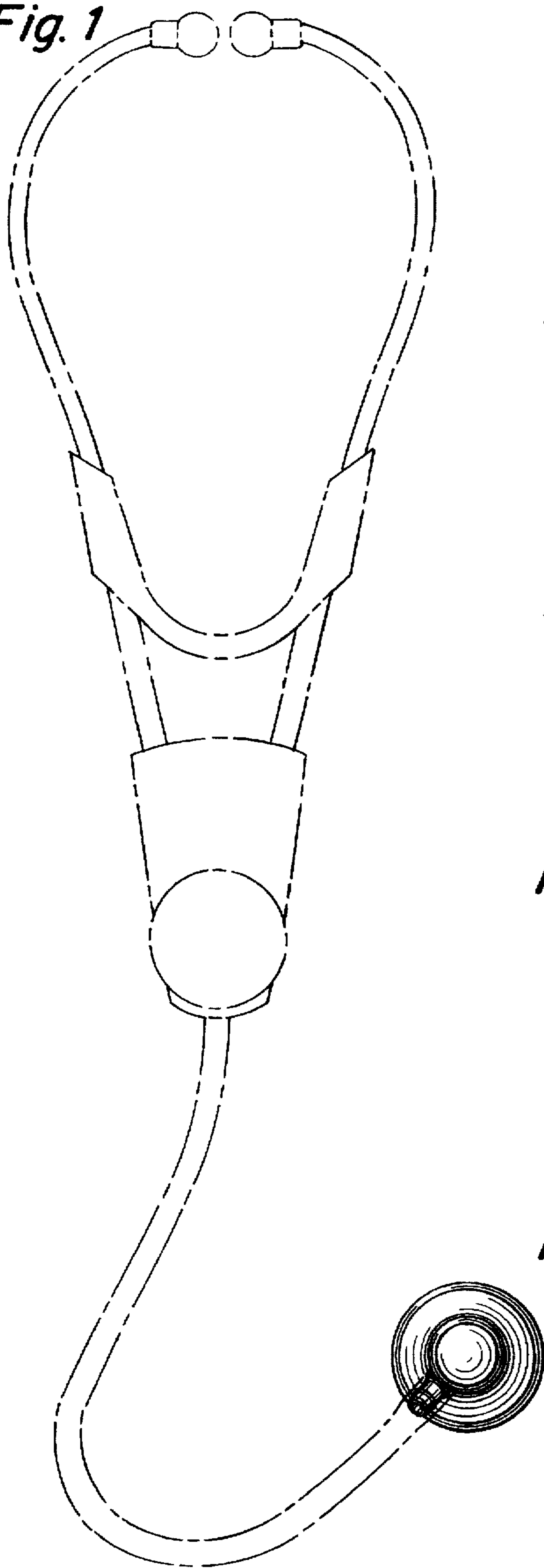

Fig. 2

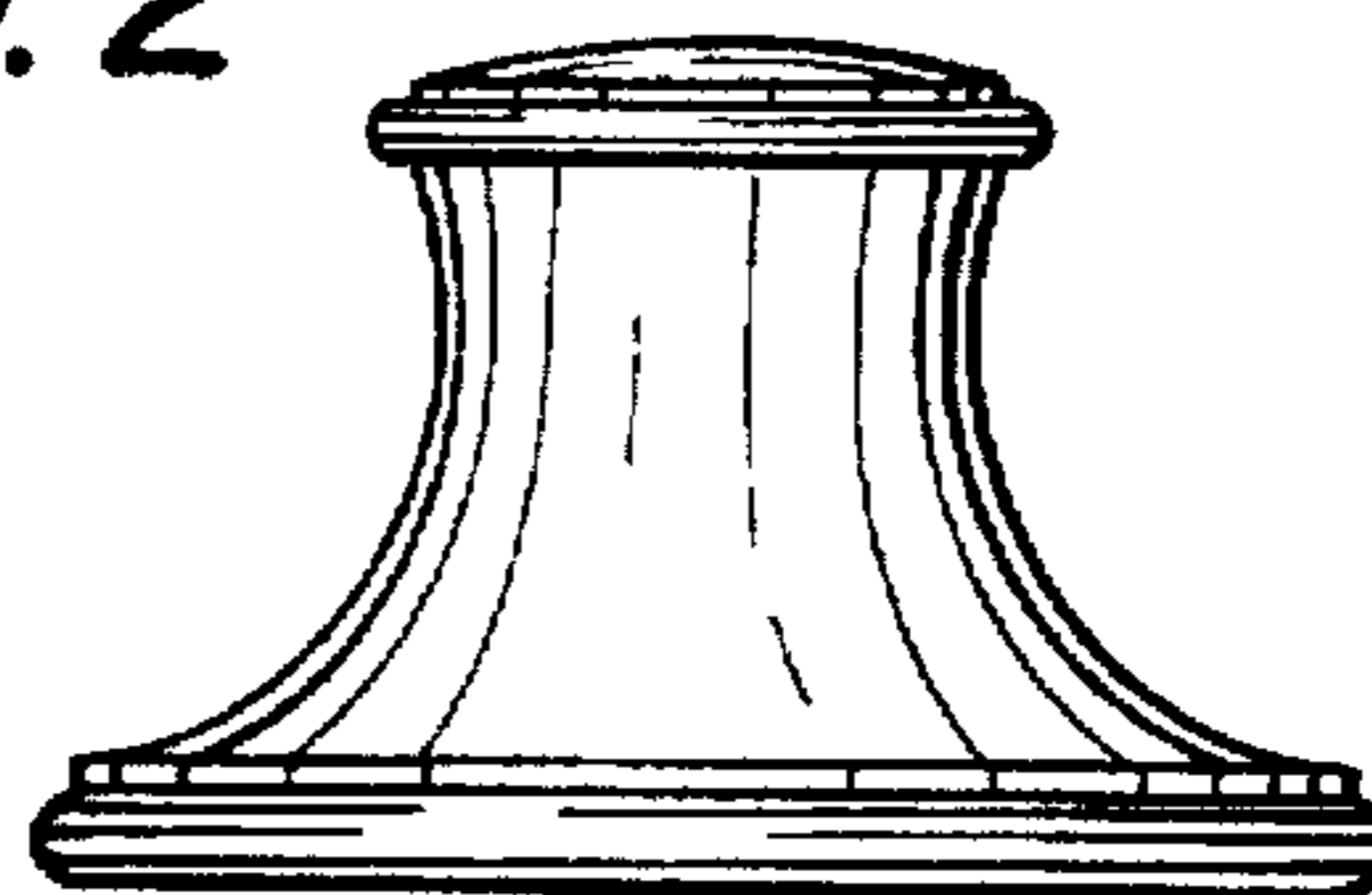

Fig. 3

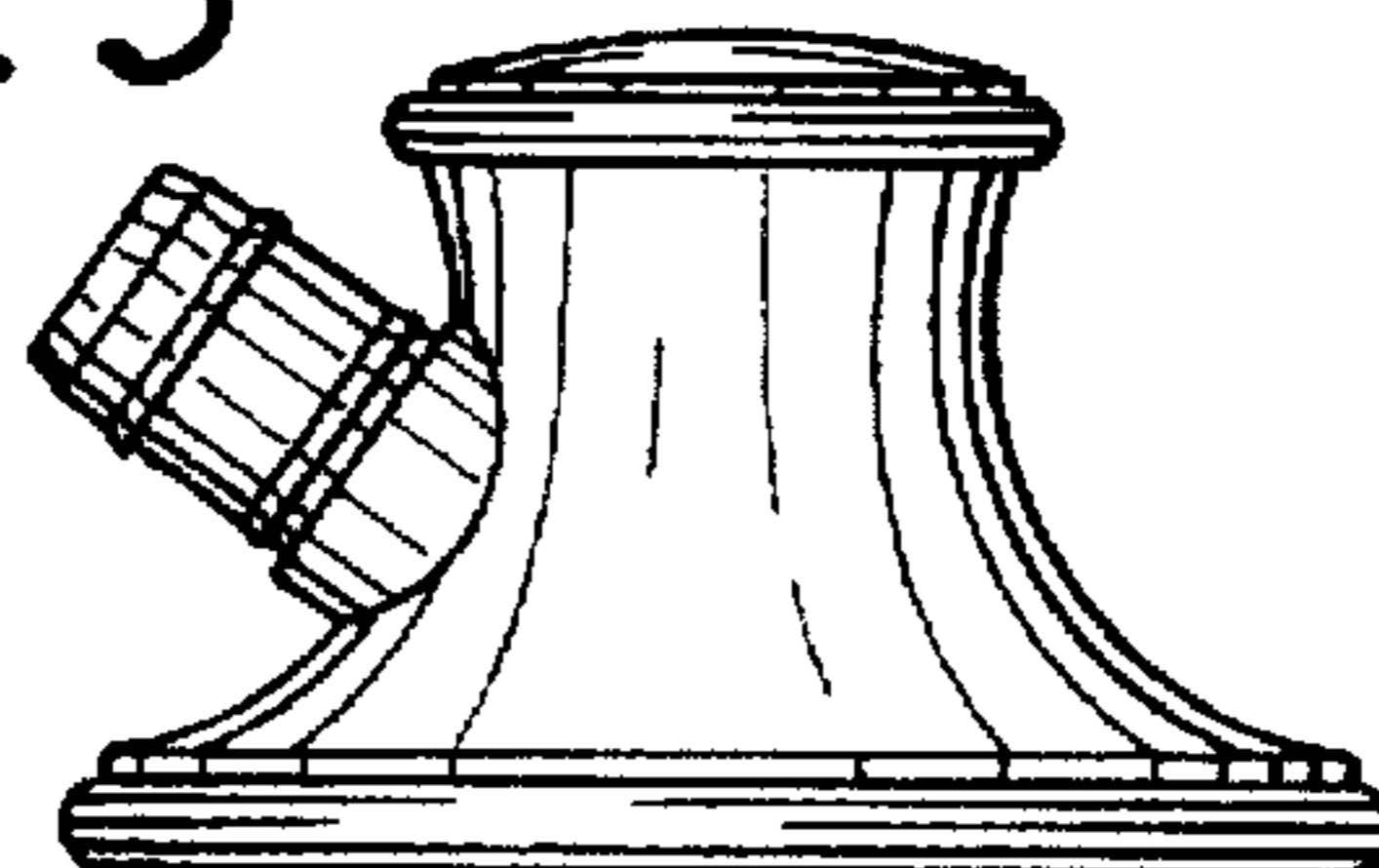

Fig. 4

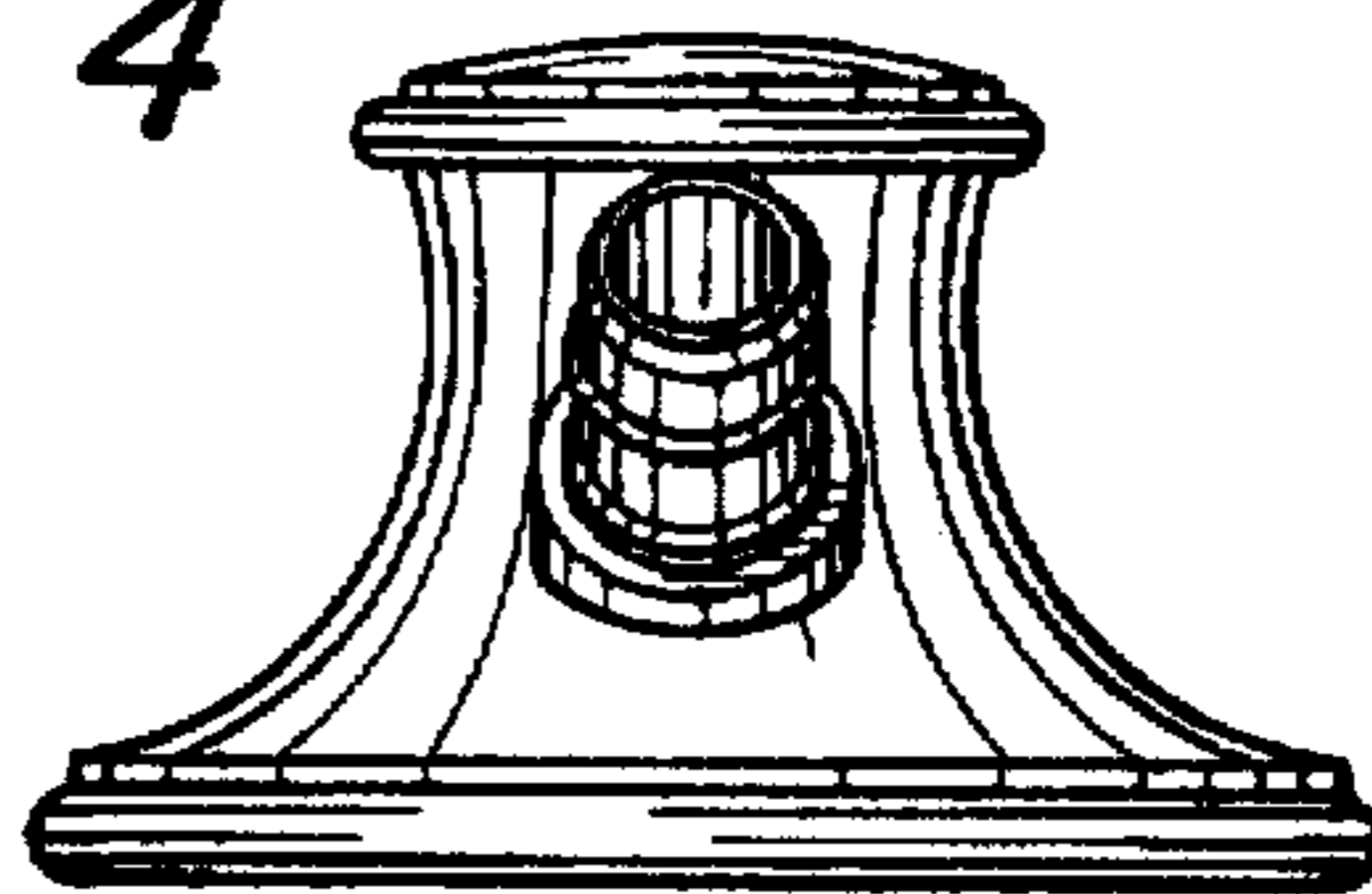

Fig. 5

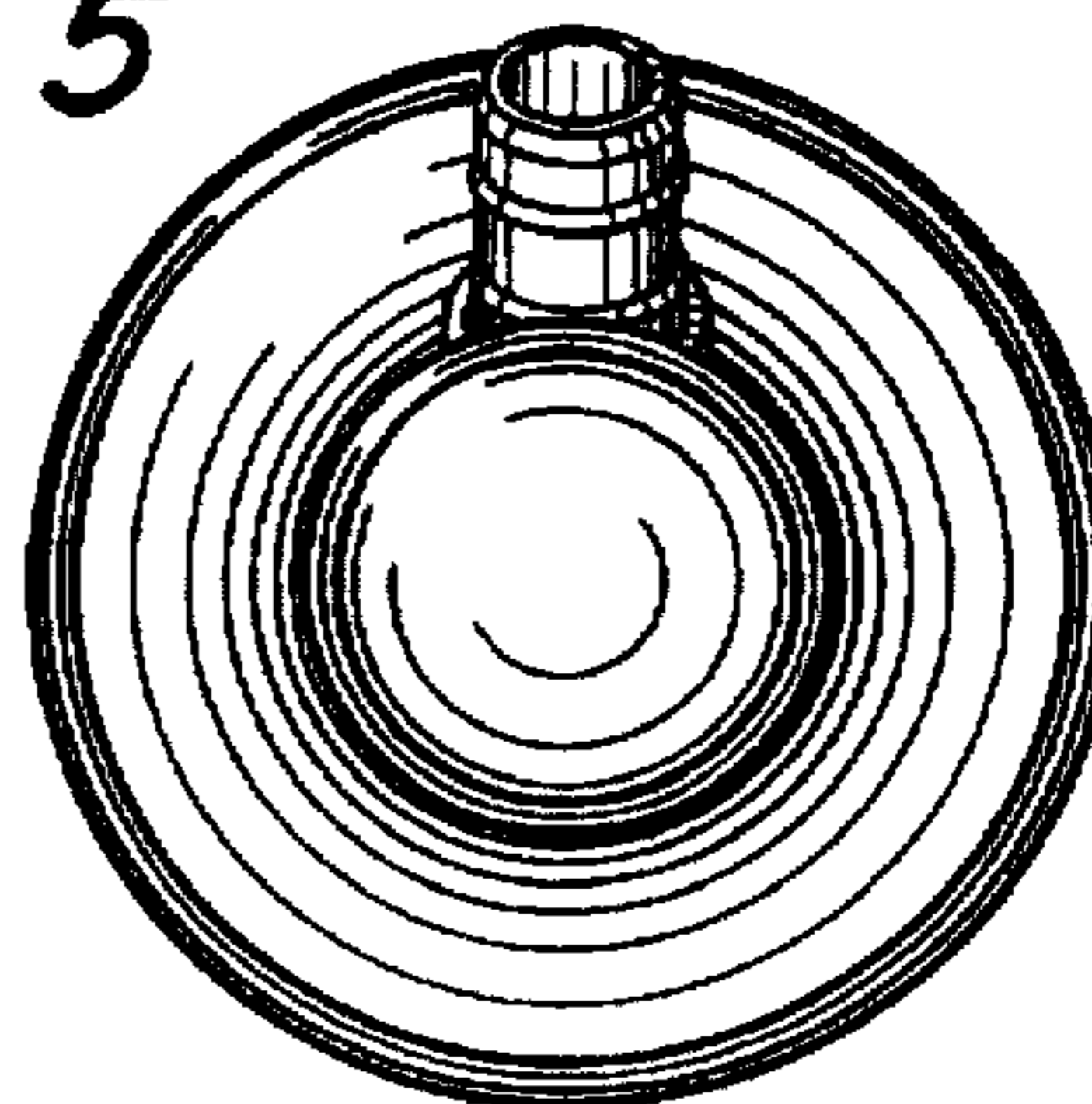
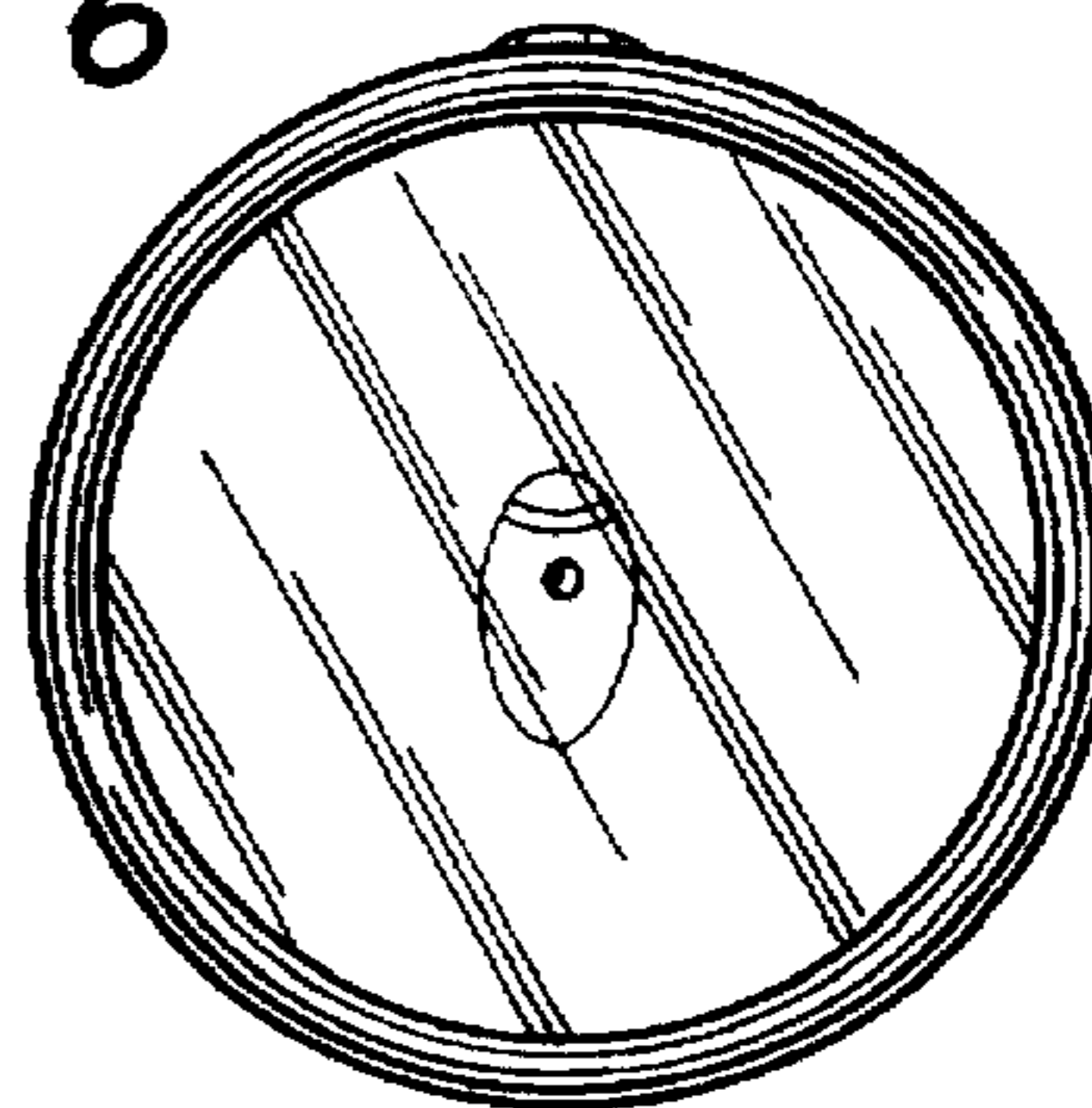

Fig. 6



UNITED STATES PATENT AND TRADEMARK OFFICE
CERTIFICATE OF CORRECTION

PATENT NO. : Des. 389,575

DATED : January 20, 1998

INVENTOR(S) : James A. Grasfield, David E. Winston, Peter R. H. Stark, Daniela Steinhubel

It is certified that error appears in the above-identified patent and that said Letters Patent is hereby corrected as shown below:

On the title page, item [73] should be inserted as follows:

[73] Assignee: StethTech Corporation, Sharon, Massachusetts

Signed and Sealed this
Ninth Day of June, 1998

Attest:



BRUCE LEHMAN

Attesting Officer

Commissioner of Patents and Trademarks