

US00D389568S

United States Patent [19]

[11] Patent Number: **Des. 389,568**

Gee, II et al.

[45] Date of Patent: ****Jan. 20, 1998**

[54] **COMBINED CEILING FAN MOTOR HOUSING, SWITCH HOUSING, AND BLADE IRONS UNIT**

[75] Inventors: **Jack W. Gee, II**, Memphis; **Masao Tsuji**, Germantown, both of Tenn.

[73] Assignee: **Hunter Fan Company**, Memphis, Tenn.

[**] Term: **14 Years**

[21] Appl. No.: **58,276**

[22] Filed: **Aug. 9, 1996**

[51] LOC (6) Cl. **23-04**

[52] U.S. Cl. **D23/411; D23/377; D23/379**

[58] Field of Search **D23/411, 377, D23/379, 385; 416/210 R, 5; 392/364; D26/81-86, 88, 59, 72, 51; 362/96**

[56] **References Cited**

U.S. PATENT DOCUMENTS

D. 270,943	10/1983	Dennis	D23/411
D. 349,337	8/1994	Tsuji	D23/385
D. 358,877	5/1995	Tsuji	D23/377
D. 358,878	5/1995	Tsuji	D23/385

OTHER PUBLICATIONS

Hunter Fan Co. Adv. Brochure, p. 27, Ceiling Fan A, top left side of page, and p. 49, Ceiling Fan B, top left side of page. Winnower Fan Co. Inc. Cat., p. 5, Ceiling Fan C.

Primary Examiner—Lisa Lichtenstein

Attorney, Agent, or Firm—Baker, Donelson, Bearman & Caldwell

[57] **CLAIM**

The ornamental design for a combined ceiling fan motor housing, switch housing, and blade irons unit, as shown and described.

DESCRIPTION

FIG. 1 is a perspective view of a combined ceiling fan motor housing, switch housing, and blade irons unit, showing our new design;

FIG. 2 is an additional perspective view showing environmental structure, the broken lines forming no part of the design;

FIG. 3 is a front elevational view thereof;

FIG. 4 is a right side elevational view thereof;

FIG. 5 is a rear elevational view thereof;

FIG. 6 is a left side elevational view thereof;

FIG. 7 is a bottom view thereof; and,

FIG. 8 is a top view thereof.

1 Claim, 8 Drawing Sheets

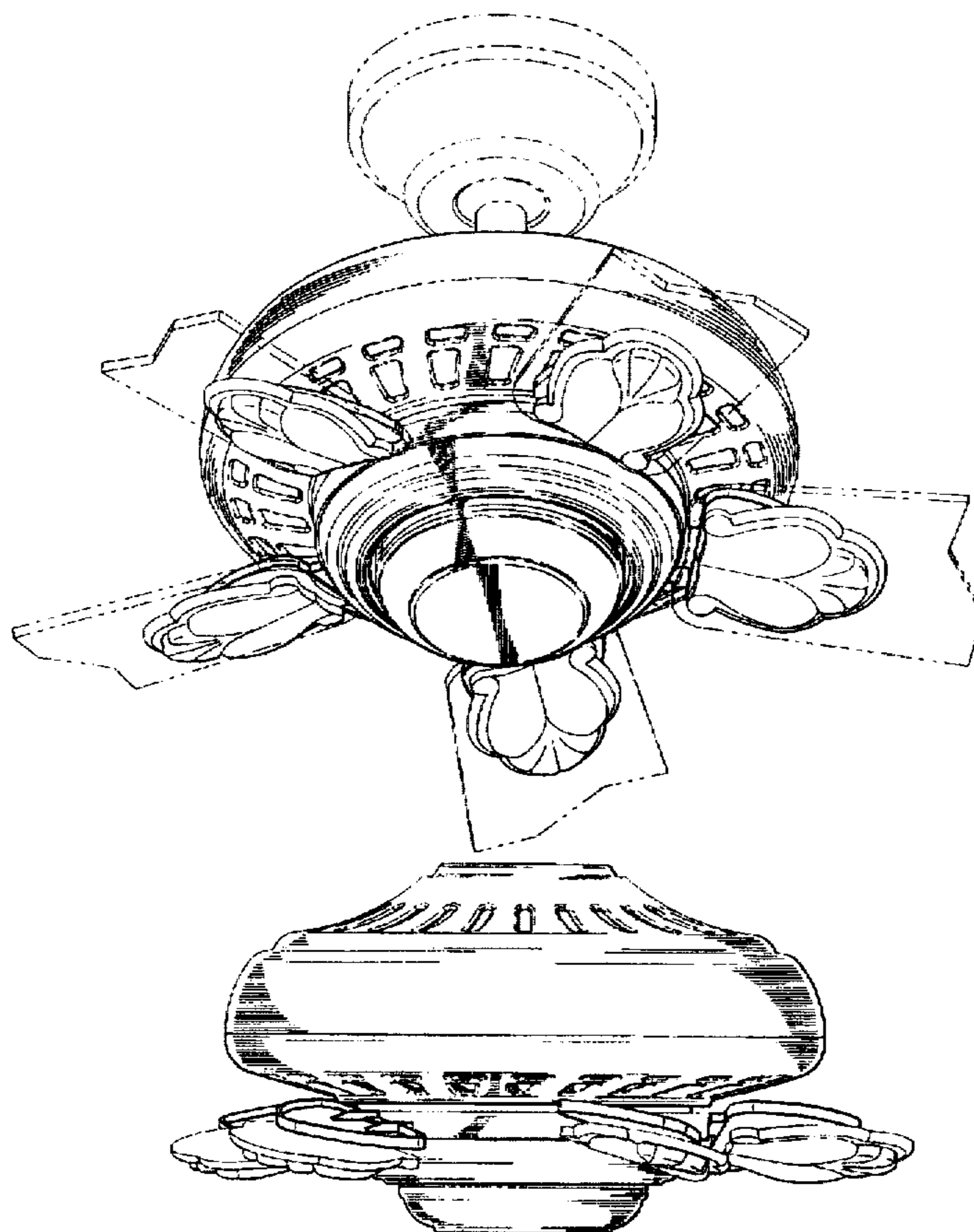

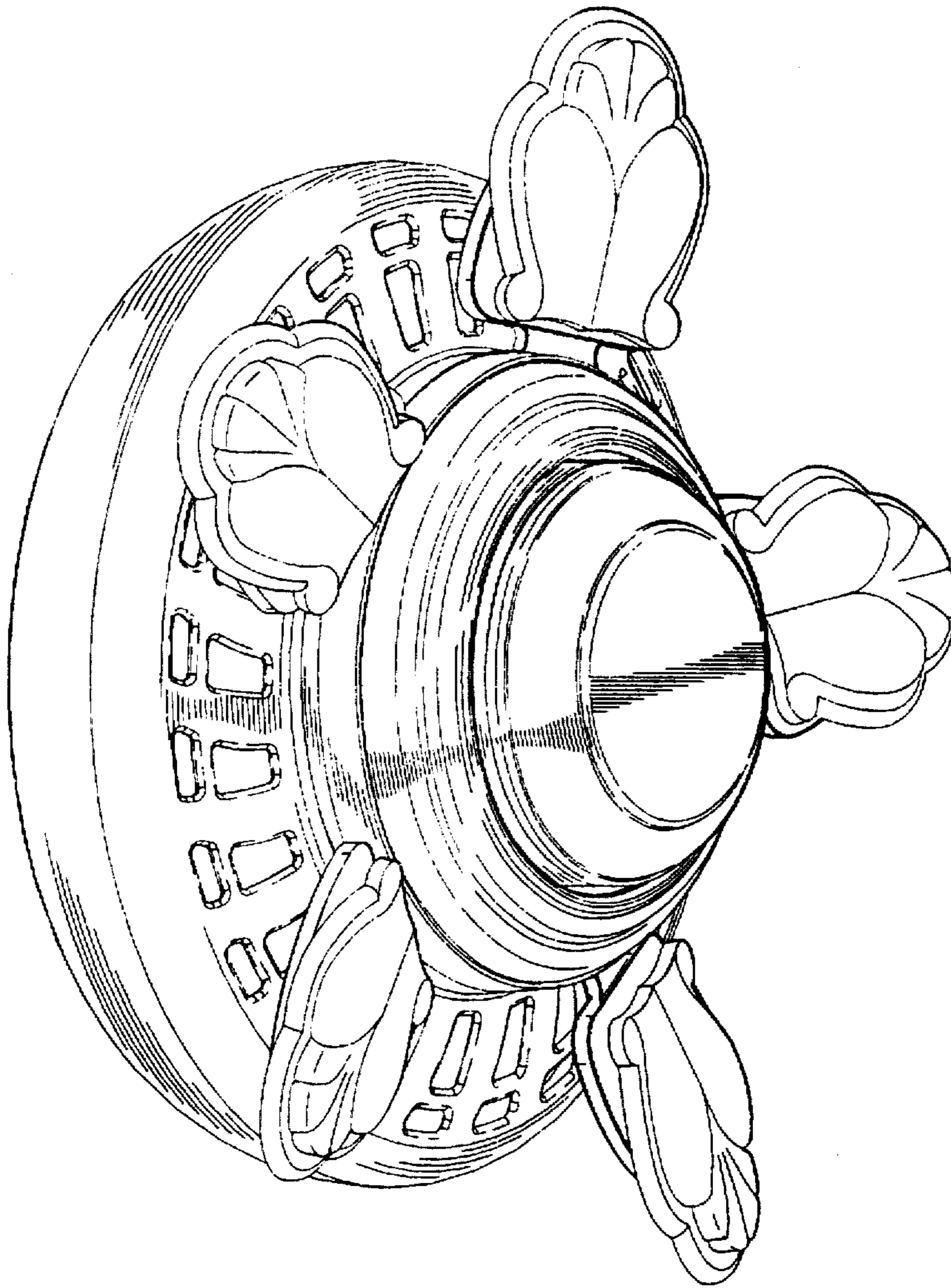

FIG 1

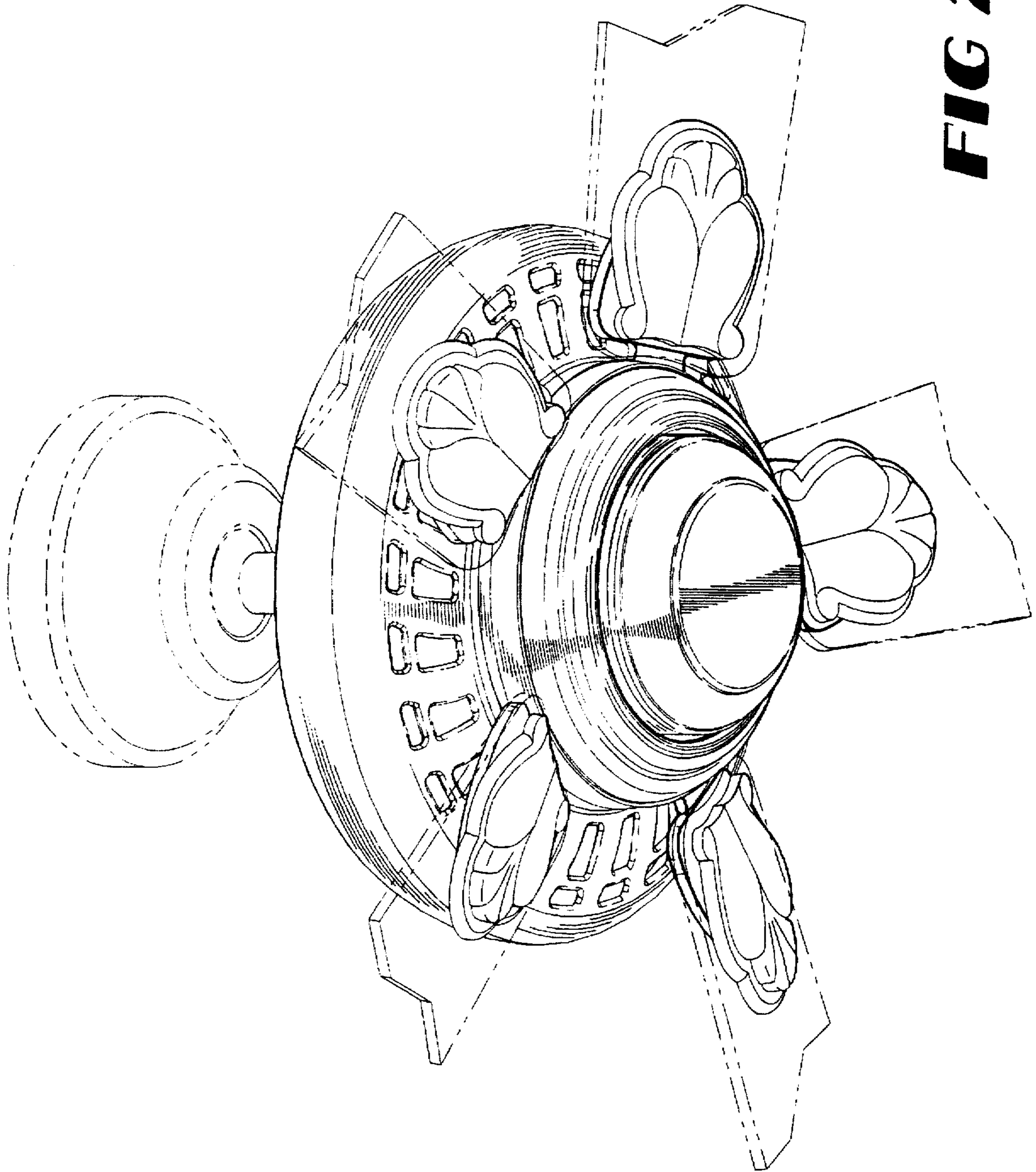

FIG 2

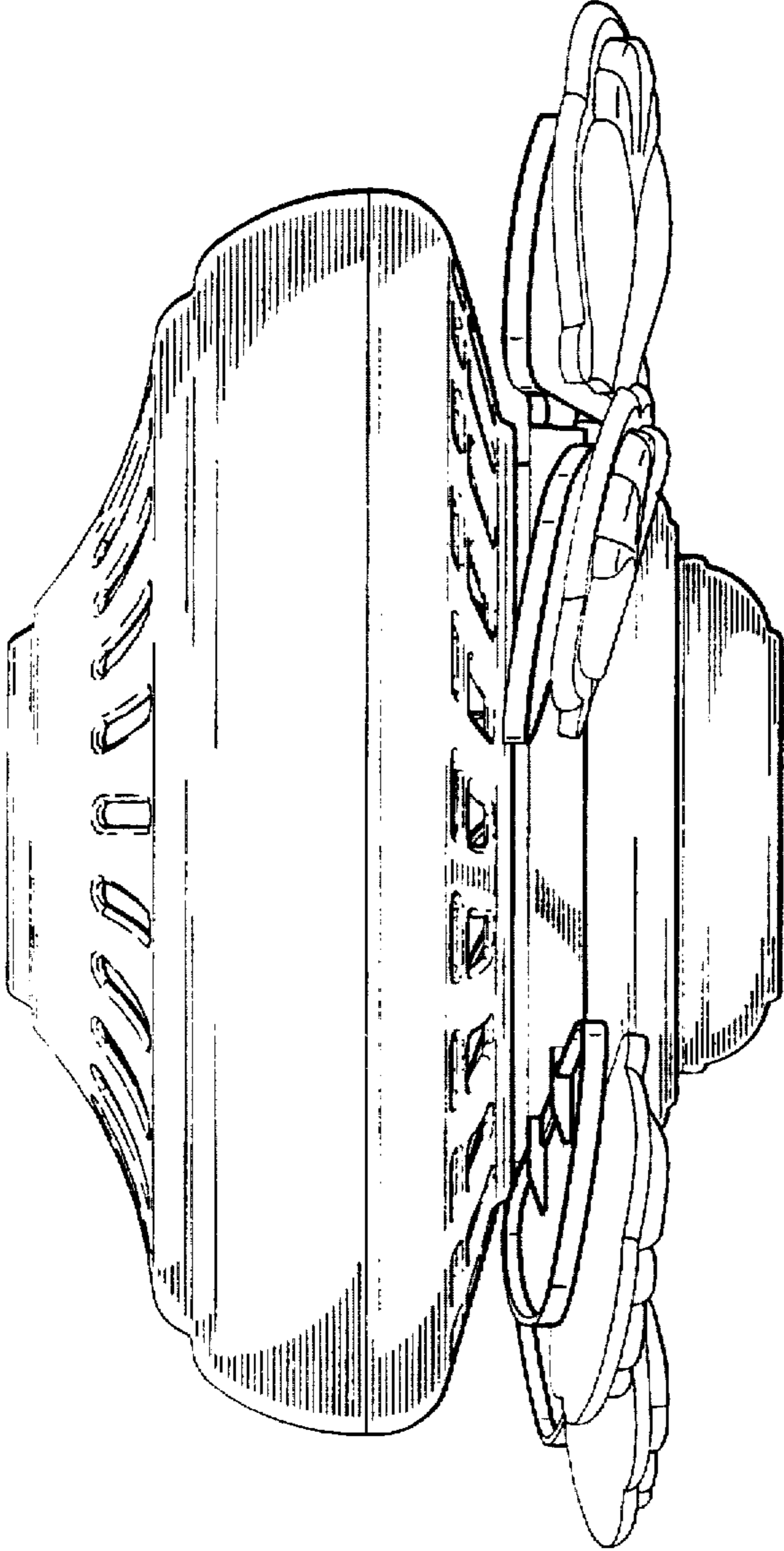

FIG 3

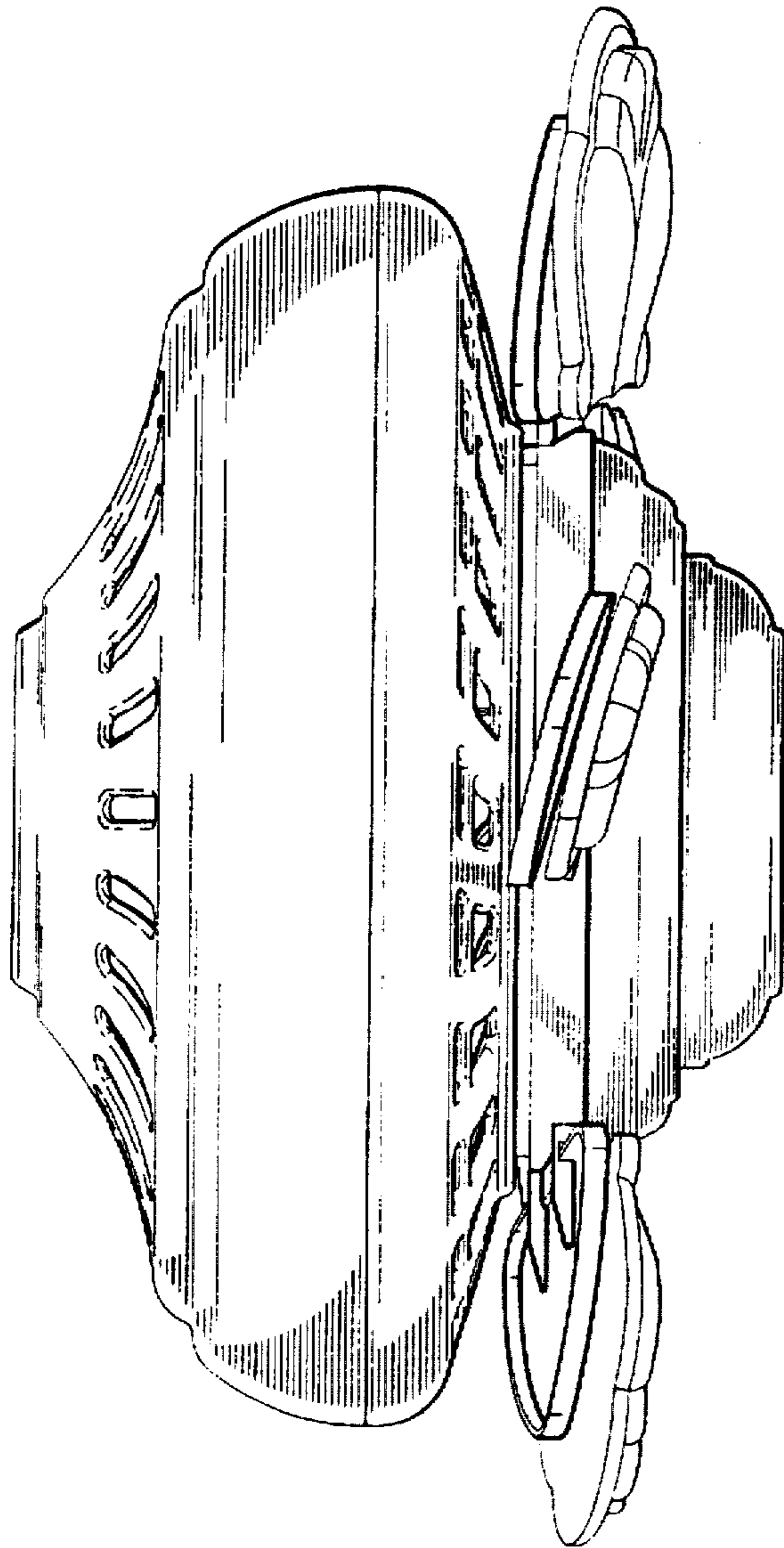

FIG 4

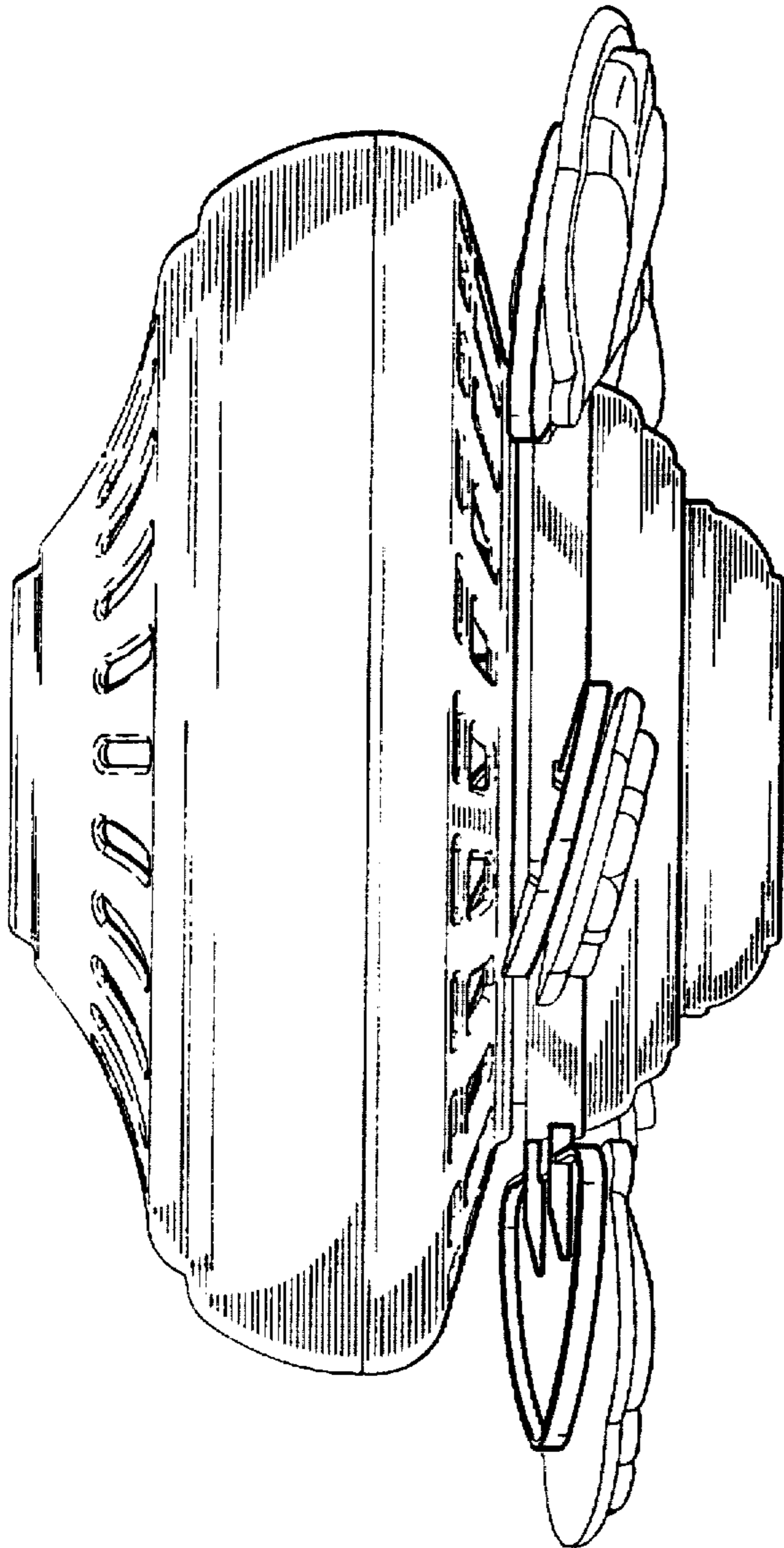

FIG 5

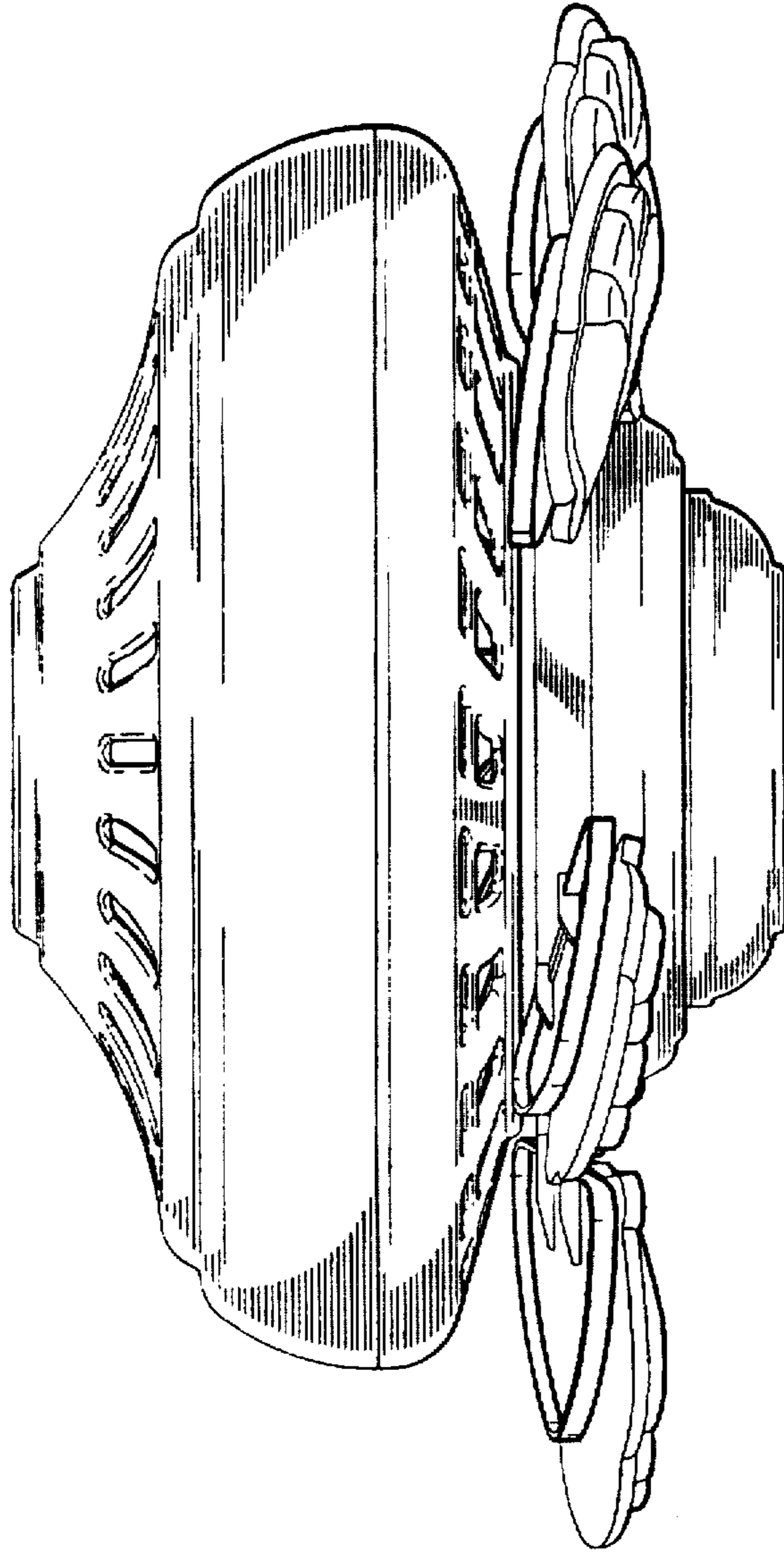

FIG 6

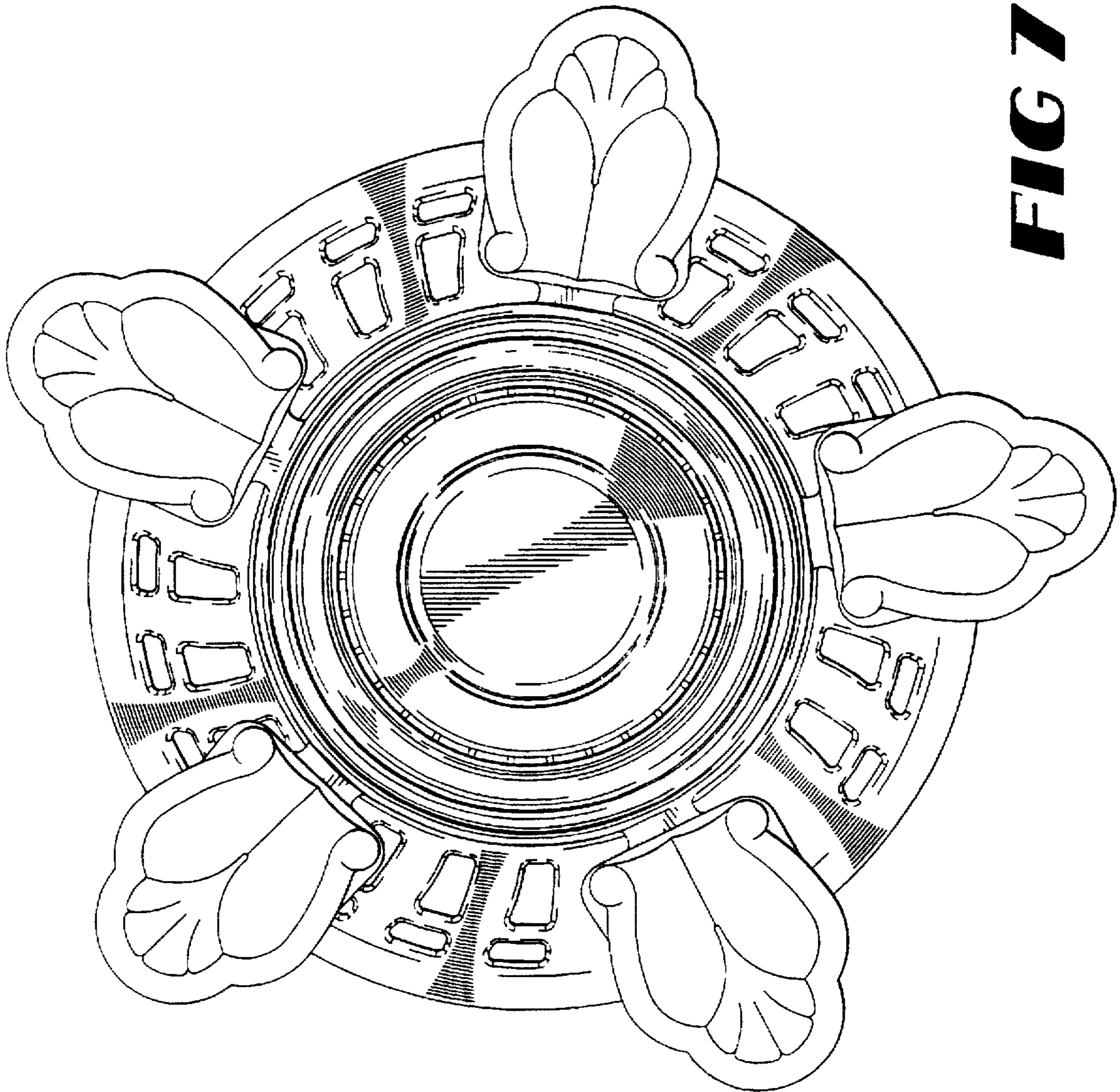

FIG 7

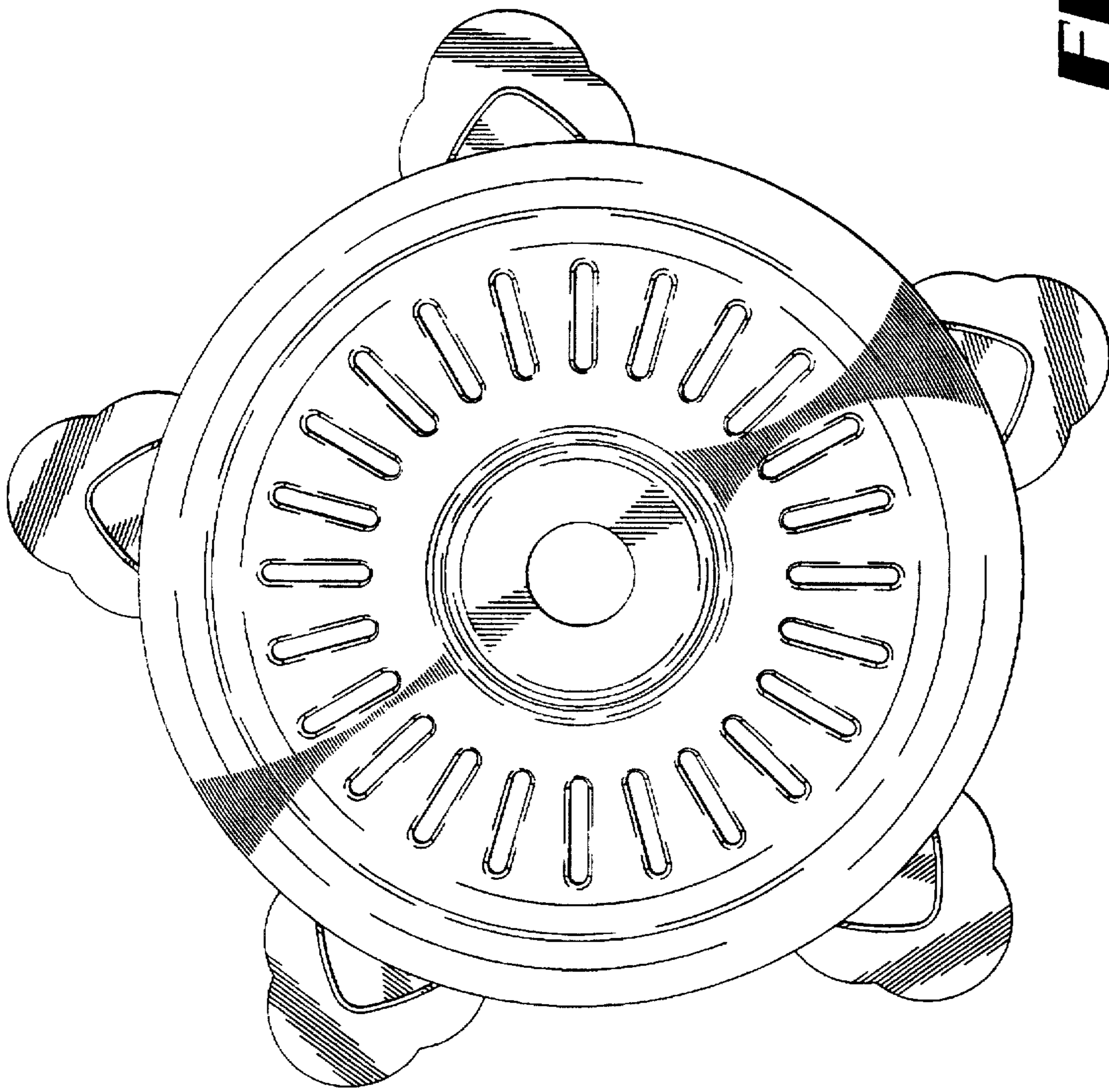

FIG 8