



US00D389536S

# United States Patent [19]

Mira Verdu

[11] Patent Number: Des. 389,536

[45] Date of Patent: \*\*Jan. 20, 1998

[54] **MINIATURE TOY MOTORCYCLE**

[76] Inventor: **Ramon Mira Verdu**, Castalla, 21, Ibi (Alicante), Spain

[\*\*] Term: **14 Years**

[21] Appl. No.: **43,645**

[22] Filed: **Sep. 8, 1995**

2,109,316	2/1938	Harley .....	180/219
2,330,341	9/1943	Du Pont et al. ....	180/219
4,506,754	3/1985	Hirano .....	180/219
4,549,629	10/1985	Komuro .....	180/219
4,871,041	10/1989	Saito et al. ....	180/219
4,938,092	7/1990	Nebo et al. ....	180/219
5,109,942	5/1992	Akimori et al. ....	180/219

### Related U.S. Application Data

[63] Continuation-in-part of Ser. No. 21,229, Apr. 11, 1994, abandoned.

### Foreign Application Priority Data

Nov. 11, 1993 [ES] Spain ..... 131090

[51] **LOC (6) CL.** ..... **21-01**

[52] **U.S. Cl.** ..... **D21/134**

[58] **Field of Search** ..... D21/76, 80, 81, D21/128, 134; D12/110; 446/440; 280/827, 828, 1.13, 87.01, 87.021; 180/219, 288.4

### References Cited

#### U.S. PATENT DOCUMENTS

D. 233,357 10/1974 Krumholz ..... D21/134

D. 276,060 10/1984 Smollar ..... D21/134

### OTHER PUBLICATIONS

Harley-Davidson Catalog, 1989, p. 3.

*Primary Examiner*—Raphael Barkai  
*Attorney, Agent, or Firm*—Darby & Darby

### CLAIM

[57] The ornamental design for a miniature toy motorcycle, as shown.

### DESCRIPTION

FIG. 1 is a front view of a miniature toy motorcycle in accordance with my invention;

FIG. 2 is a rear view thereof;

FIG. 3 is a perspective view thereof;

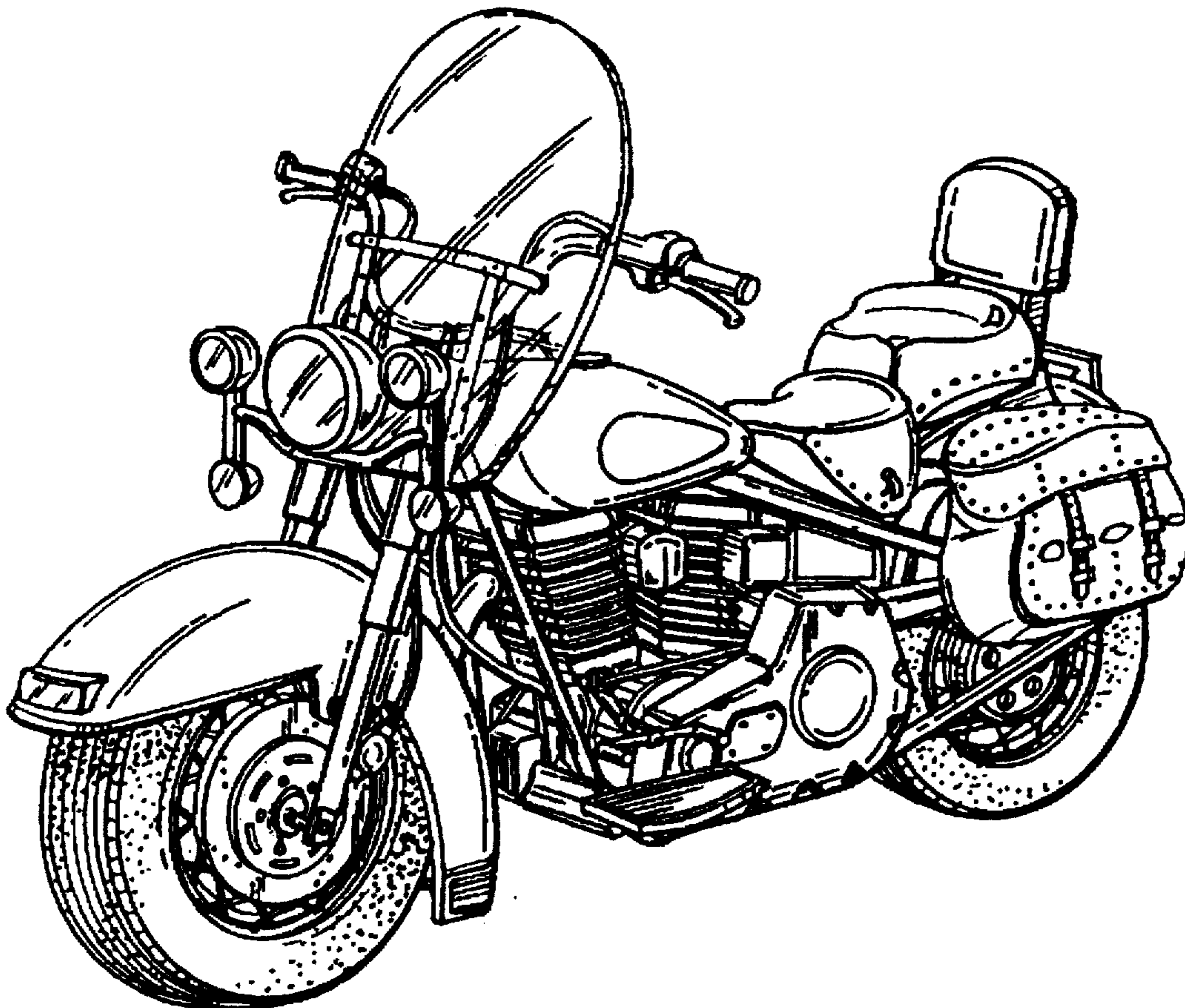
FIG. 4 is a left side view thereof;

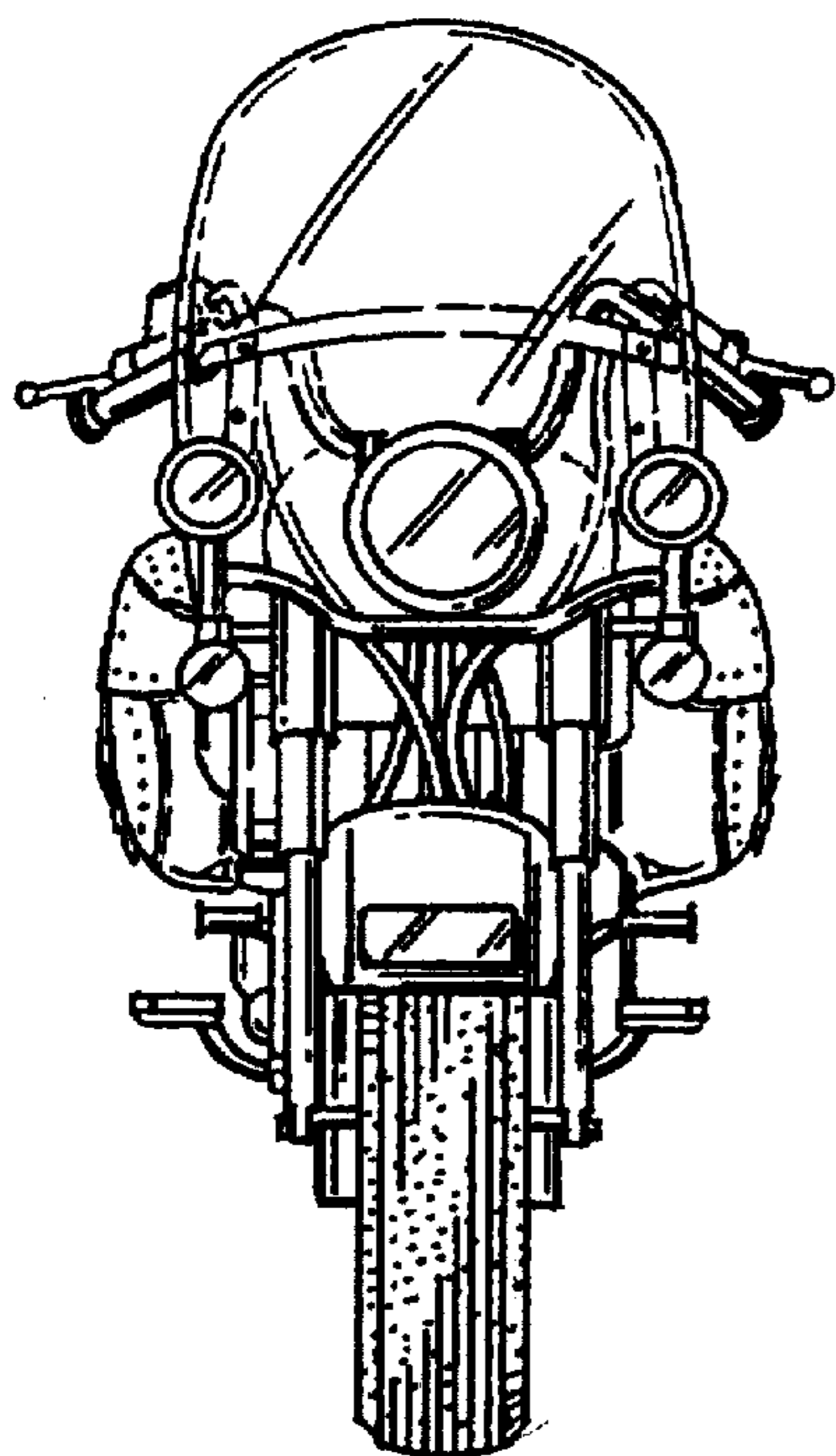
FIG. 5 is a right side view thereof;

FIG. 6 is a top view thereof; and,

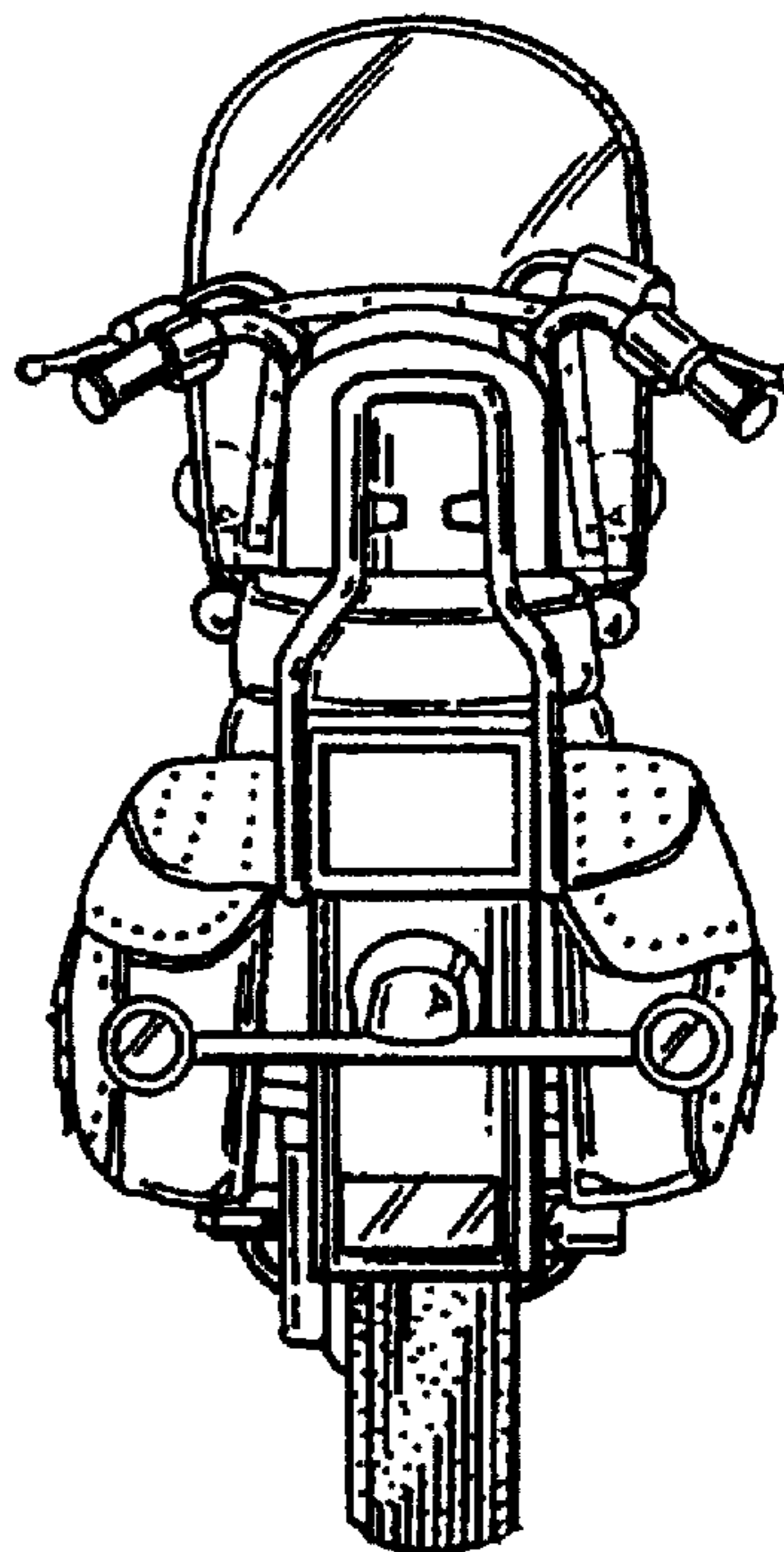
FIG. 7 is a bottom view thereof.

1 Claim, 3 Drawing Sheets

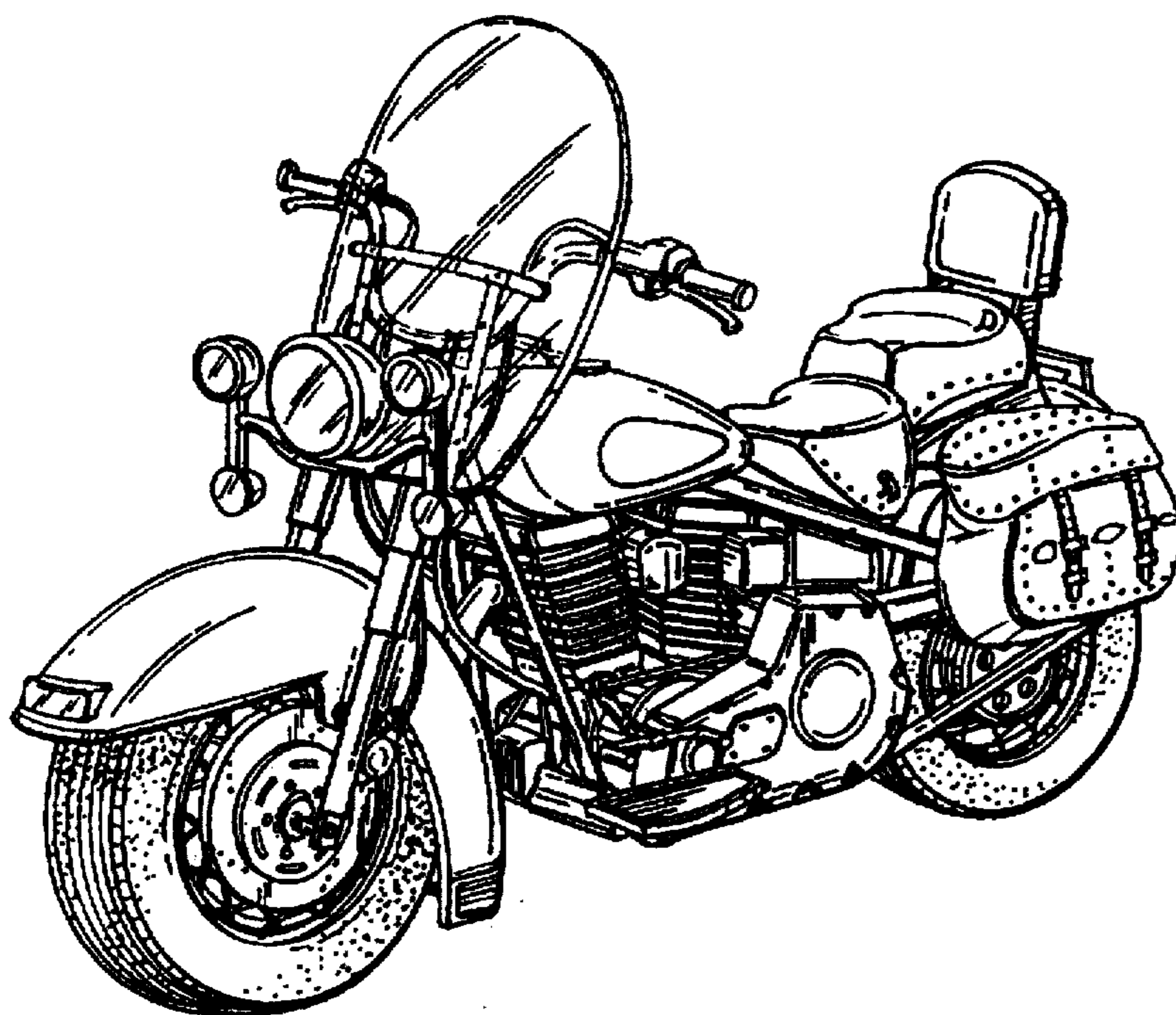




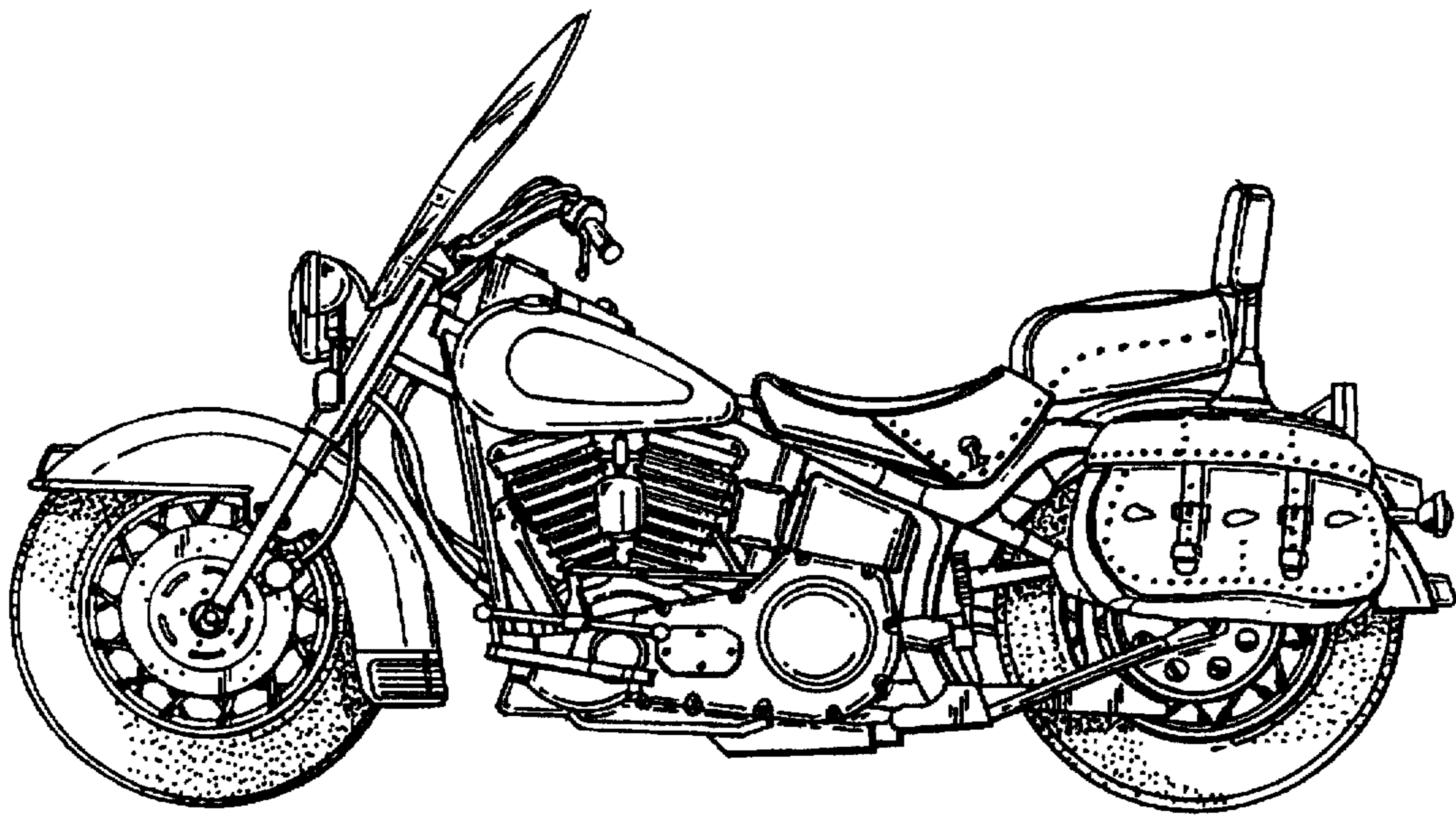
**Fig. 1**



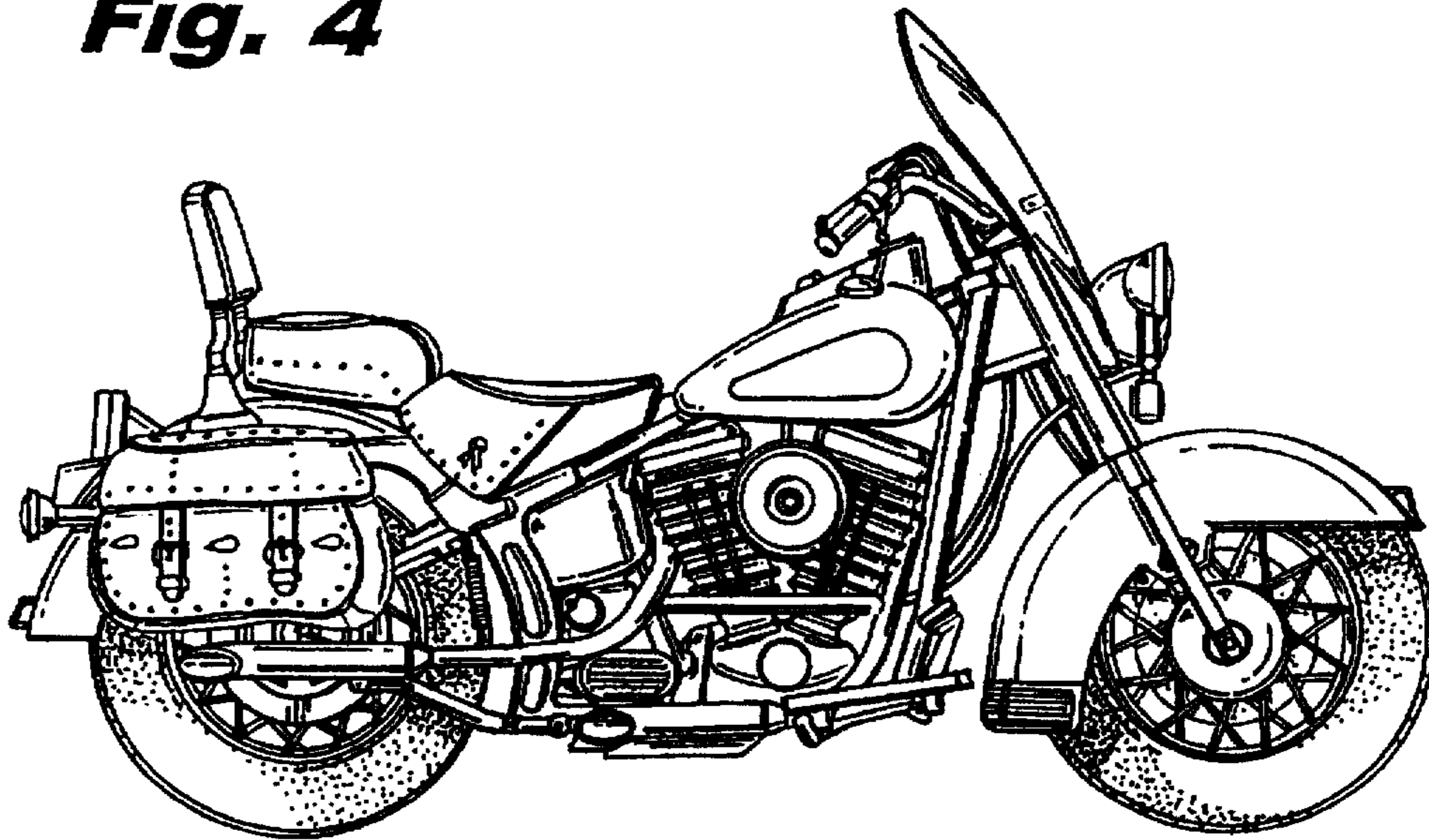
**Fig. 2**



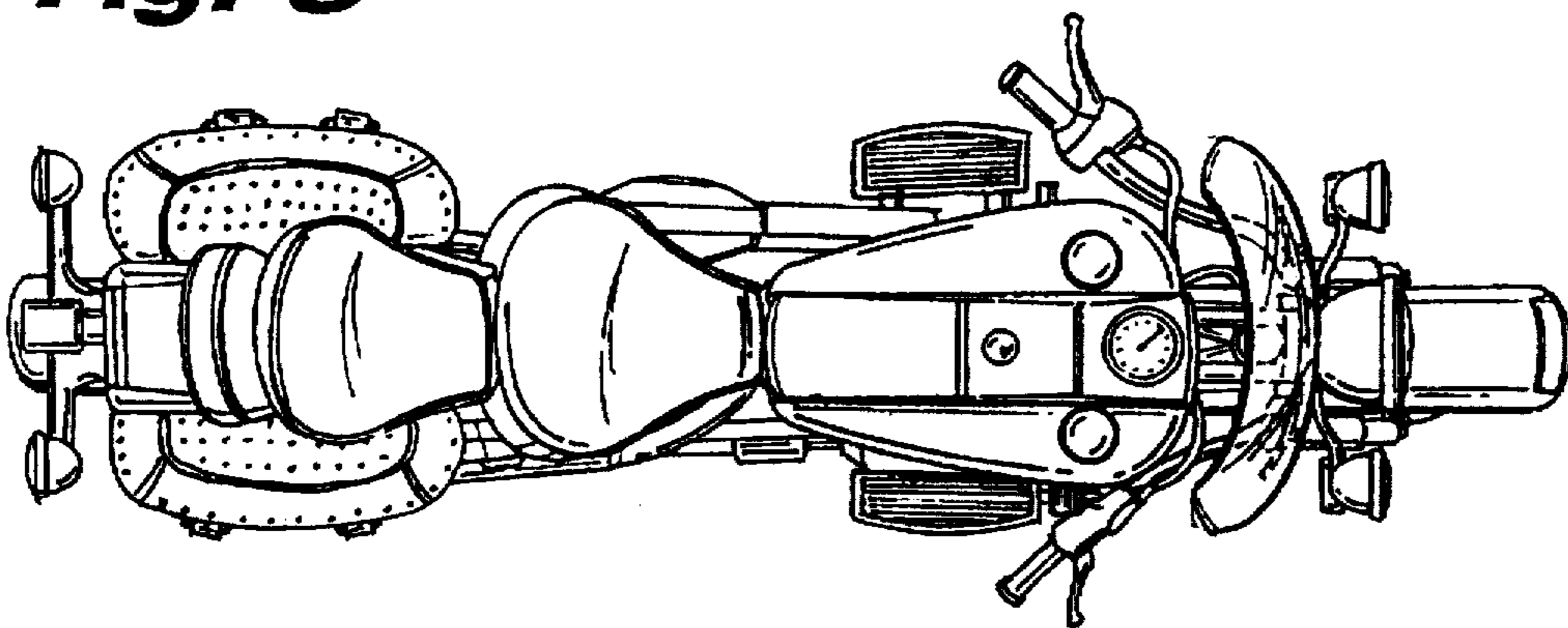
**Fig. 3**



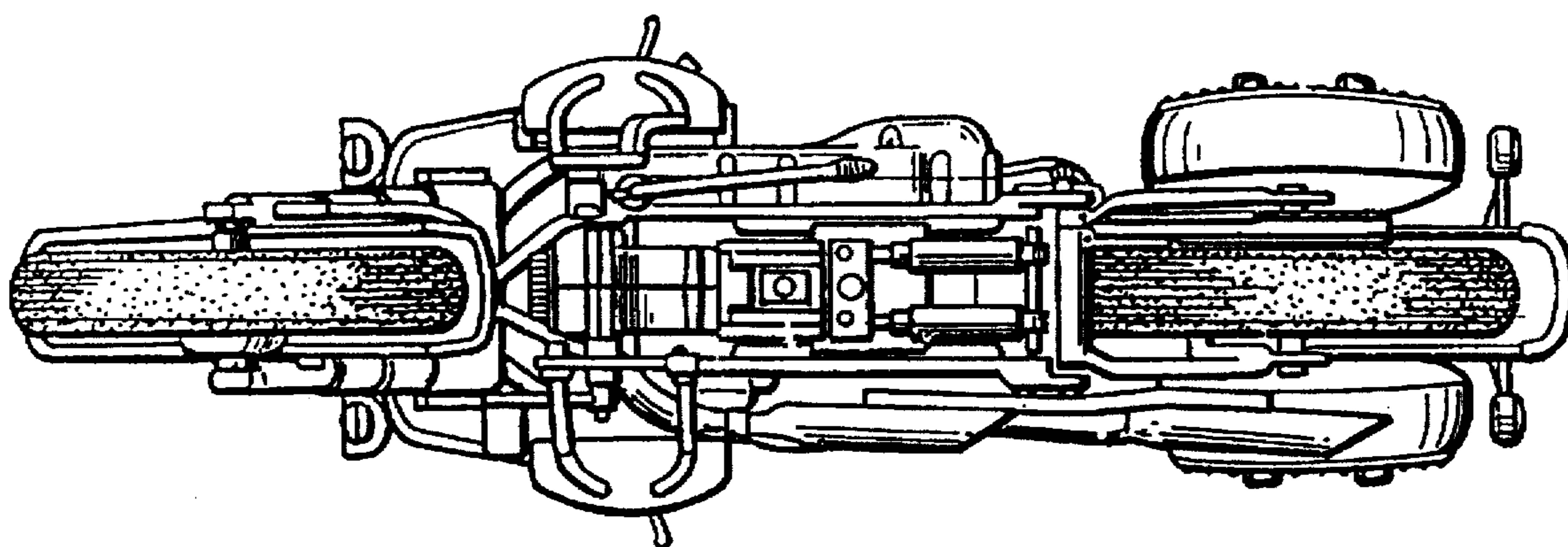
**Fig. 4**



**Fig. 5**



**Fig. 6**



***Fig. 7***