



US00D389460S

United States Patent [19]
Wei-Hong

[11] **Patent Number: Des. 389,460**
[45] **Date of Patent: **Jan. 20, 1998**

[54] **LIGHTING FIXTURE TRACK**
[75] **Inventor: Shen Wei-Hong, Taipei, Taiwan**
[73] **Assignee: Davinci Industrial Inc., Taipei Hsien, Taiwan**
[**] **Term: 14 Years**

5,584,576 12/1996 Hong 32/404 X

FOREIGN PATENT DOCUMENTS

382418 2/1990 Germany 439/121
4240220 6/1990 Germany 439/110

Primary Examiner—Susan J. Lucas
Attorney, Agent, or Firm—Morton J. Rosenberg; David I. Klein

[21] **Appl. No.: 57,106**
[22] **Filed: Jul. 16, 1996**
[30] **Foreign Application Priority Data**
Jun. 19, 1996 [CN] China 85305024
[51] **LOC (6) Cl. 13-03**
[52] **U.S. Cl. D13/155; D26/113; D26/140**
[58] **Field of Search D26/60-66; 362/147, 362/269, 275, 287, 418, 419, 427, 404, 250, 226; 439/110-122**

[57] **CLAIM**
The ornamental design for lighting fixture track, as shown and described.

DESCRIPTION

FIG. 1 is the perspective view of a lighting fixture track showing my new design;
FIG. 2 is the front elevational view thereof;
FIG. 3 is the rear elevational view thereof;
FIG. 4 is the left side elevational view thereof;
FIG. 5 is the right side elevational view thereof;
FIG. 6 is the top plan view thereof; and,
FIG. 7 is the bottom plan view thereof.

[56] **References Cited**
U.S. PATENT DOCUMENTS
5,207,589 5/1993 Lettenmayer 439/112

1 Claim, 4 Drawing Sheets

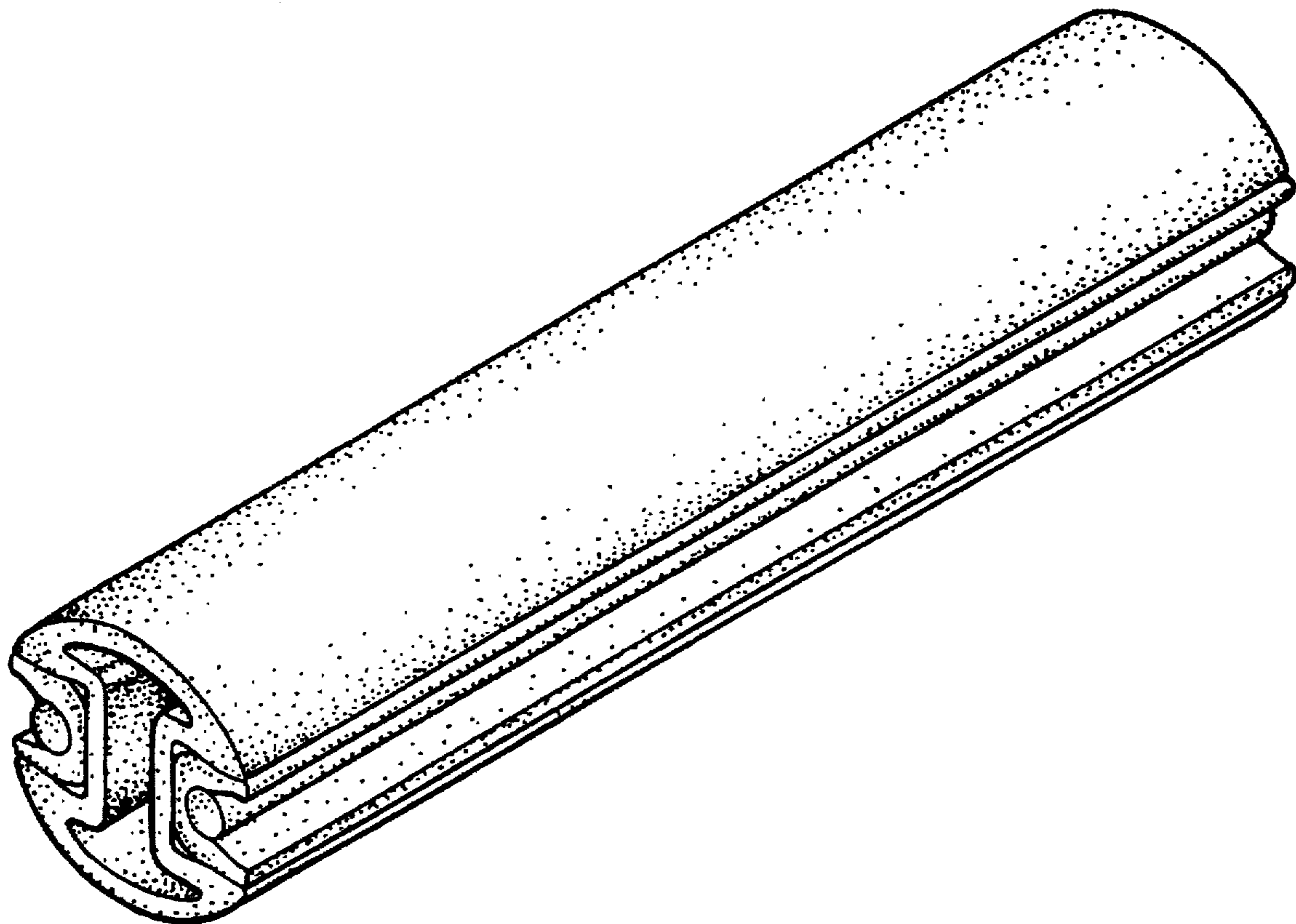

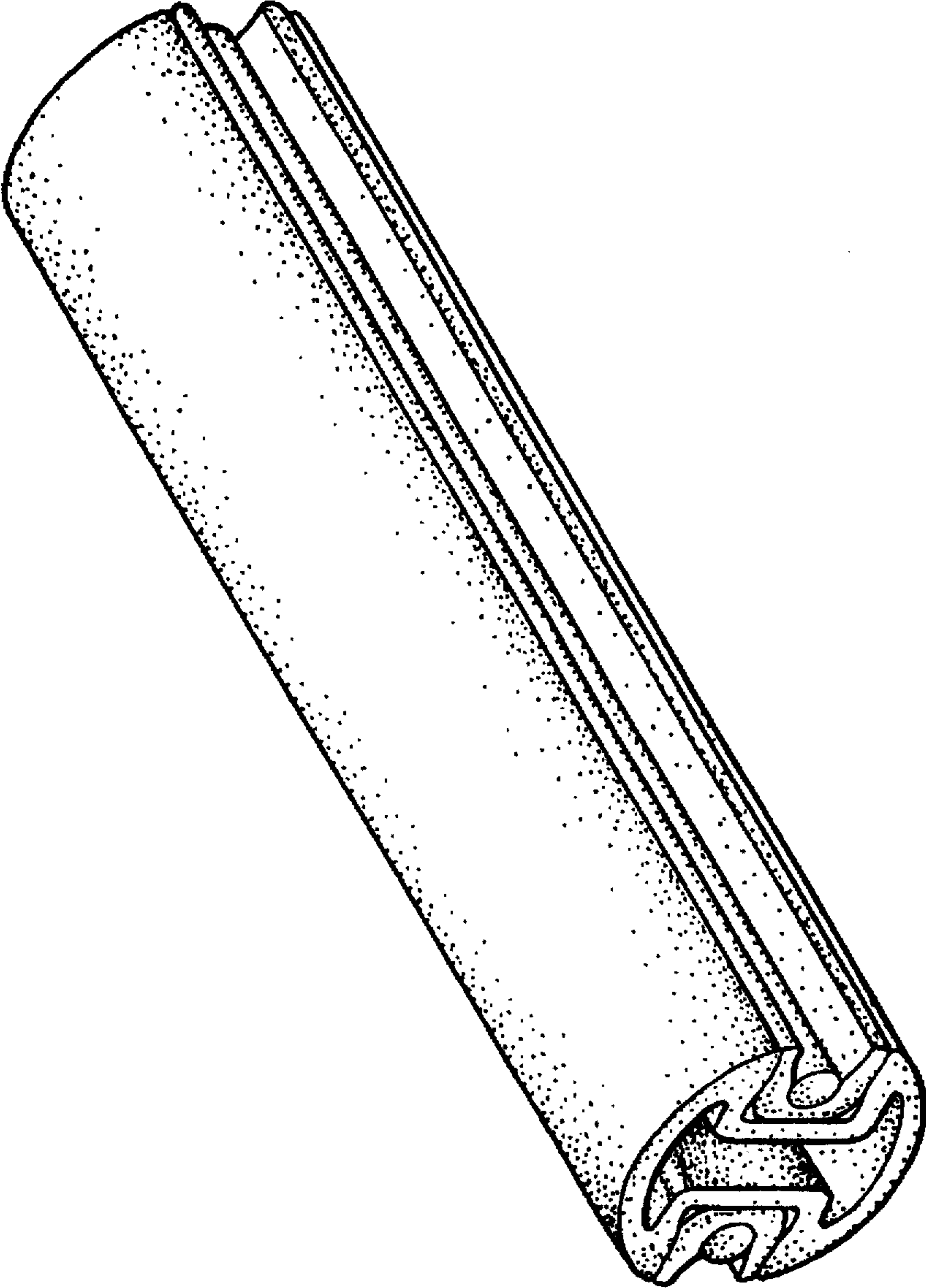

FIG. 1

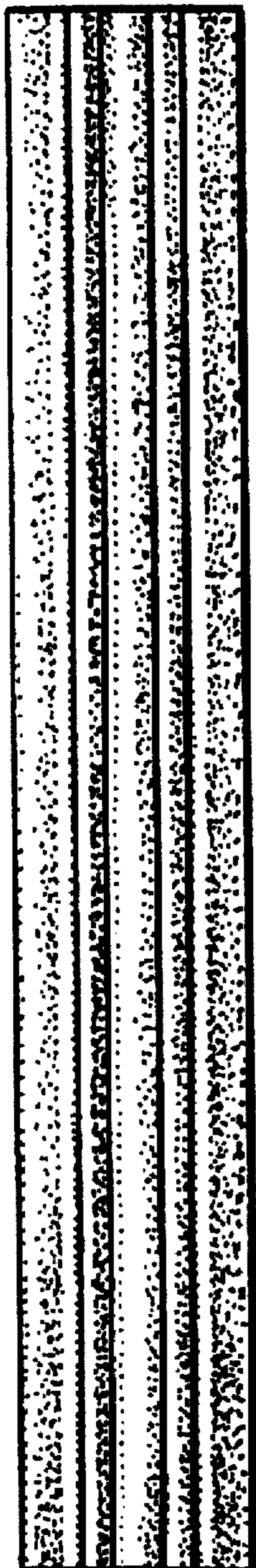

FIG. 2

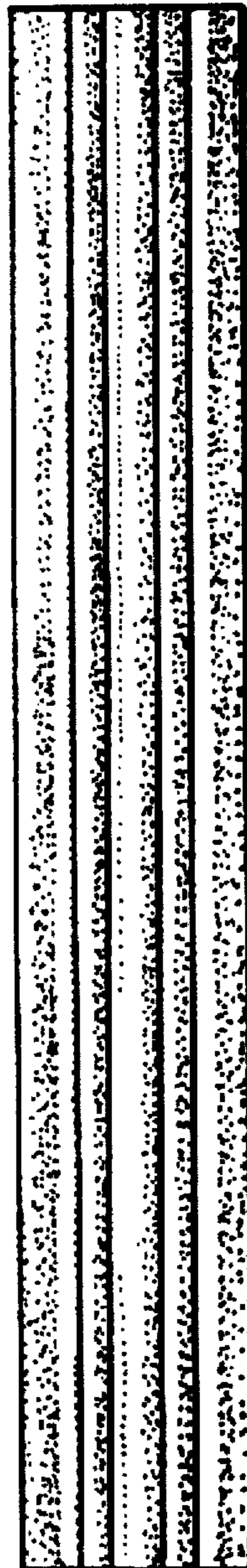

FIG. 3

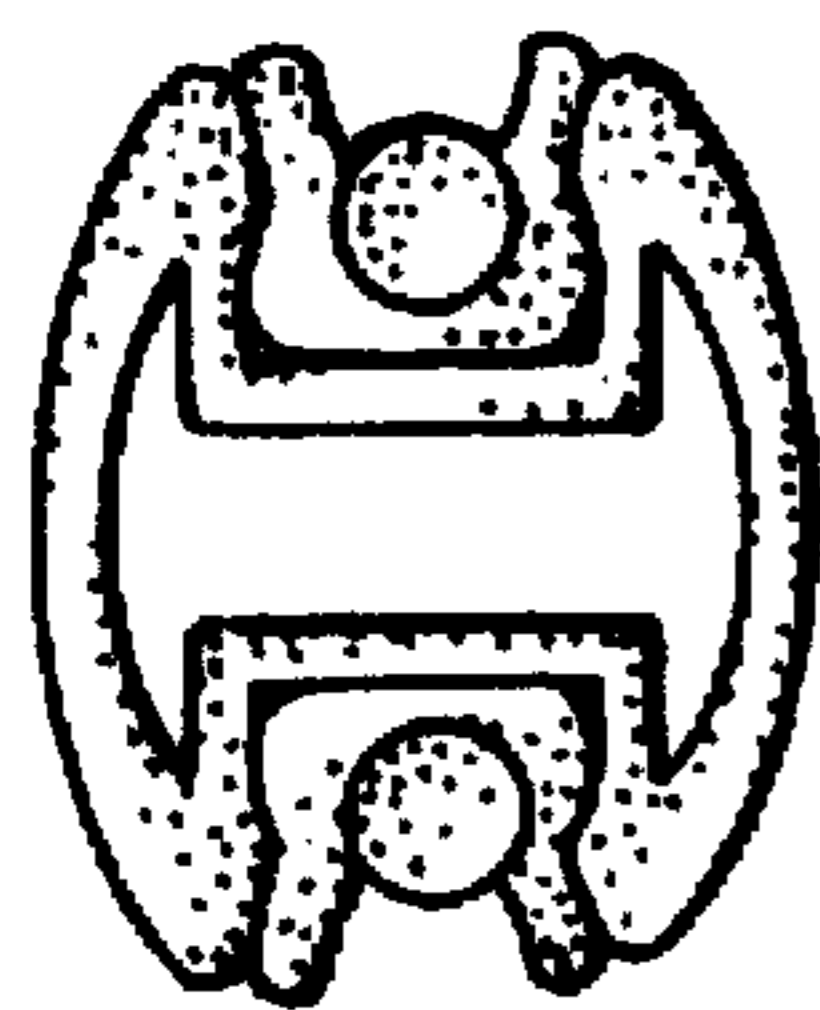

FIG. 4

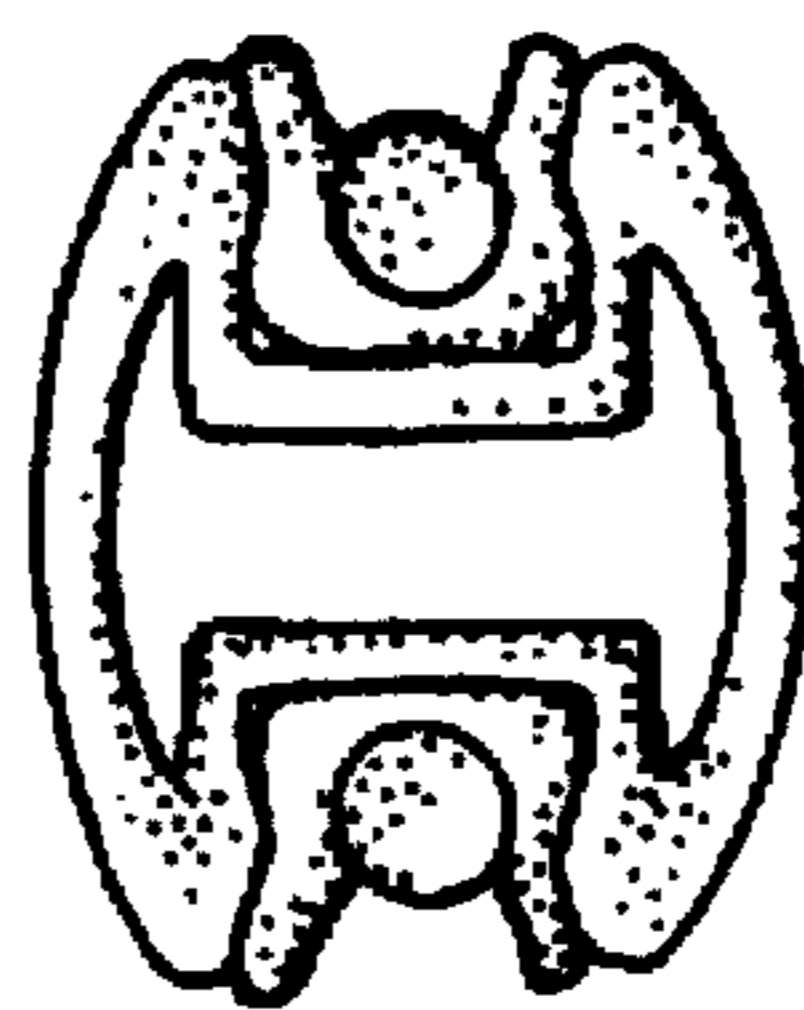

FIG. 5

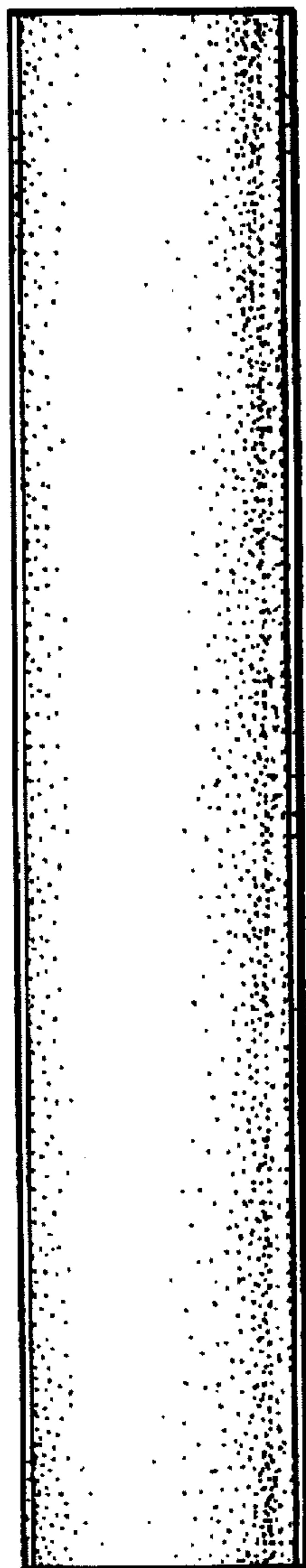

FIG. 6

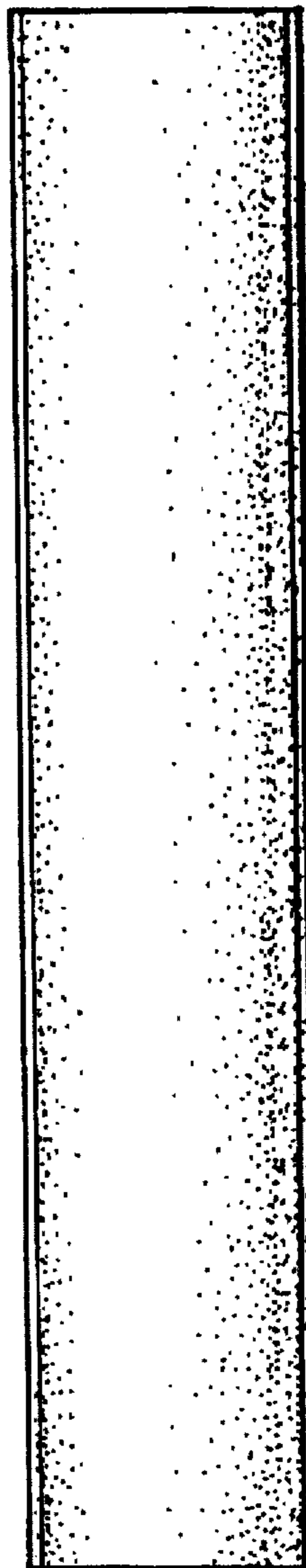

FIG. 7