



US00D389452S

United States Patent [19]

Scott

[11] Patent Number: **Des. 389,452**

[45] Date of Patent: ****Jan. 20, 1998**

[54] **AUTOMOBILE TAILGATE PARTY TABLE**

[76] Inventor: **Charles W. Scott**, 3216 Crane Ferry Rd., Augusta, Ga. 30907

[**] Term: **14 Years**

[21] Appl. No.: **24,618**

[22] Filed: **Jun. 17, 1994**

[51] LOC (6) Cl. **12-16**

[52] U.S. Cl. **D12/415**

[58] Field of Search D12/425, 400, D12/420; D6/429, 555; 108/44, 129-132; 224/42.03 R, 273, 275, 327, 329; 296/24.1

[56] **References Cited**

U.S. PATENT DOCUMENTS

D. 305,632	1/1990	Kraklio	D12/400
D. 309,065	7/1990	Huff	D12/400
3,015,530	1/1962	Anderson	108/44
3,057,670	10/1962	Russo	108/44
3,063,064	11/1962	Mace	108/44

3,709,159	1/1973	Oglesby, Jr.	108/44
4,057,125	11/1977	Kroft	D12/400
4,236,461	12/1980	Barksdale	108/44
4,452,151	6/1984	Jarrand	108/414

Primary Examiner—Melody M. Brown

[57] **CLAIM**

The ornamental design for a automobile tailgate party table, as shown and described.

DESCRIPTION

FIG. 1 is a front elevational view of the automobile tailgate party table showing my new design;
 FIG. 2 is a rear elevational view thereof;
 FIG. 3 is a left side elevational view thereof;
 FIG. 4 is a right side elevational view thereof;
 FIG. 5 is a top plan view thereof; and,
 FIG. 6 is a bottom plan view thereof; and,
 FIG. 7 is a side elevational view thereof, with the table shown in folded condition; and,
 FIG. 8 is a perspective view thereof.

1 Claim, 5 Drawing Sheets

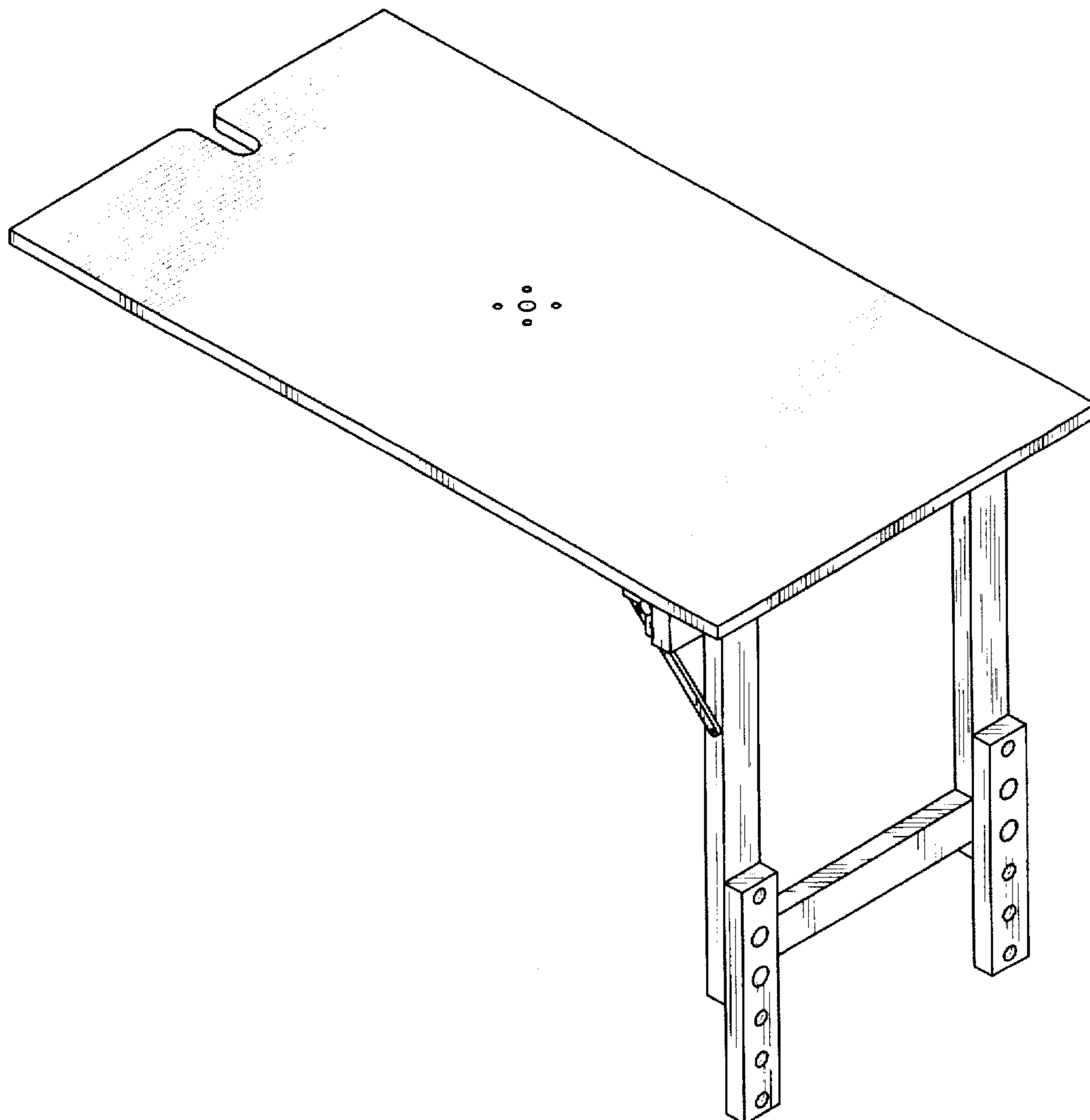

FIG. 1

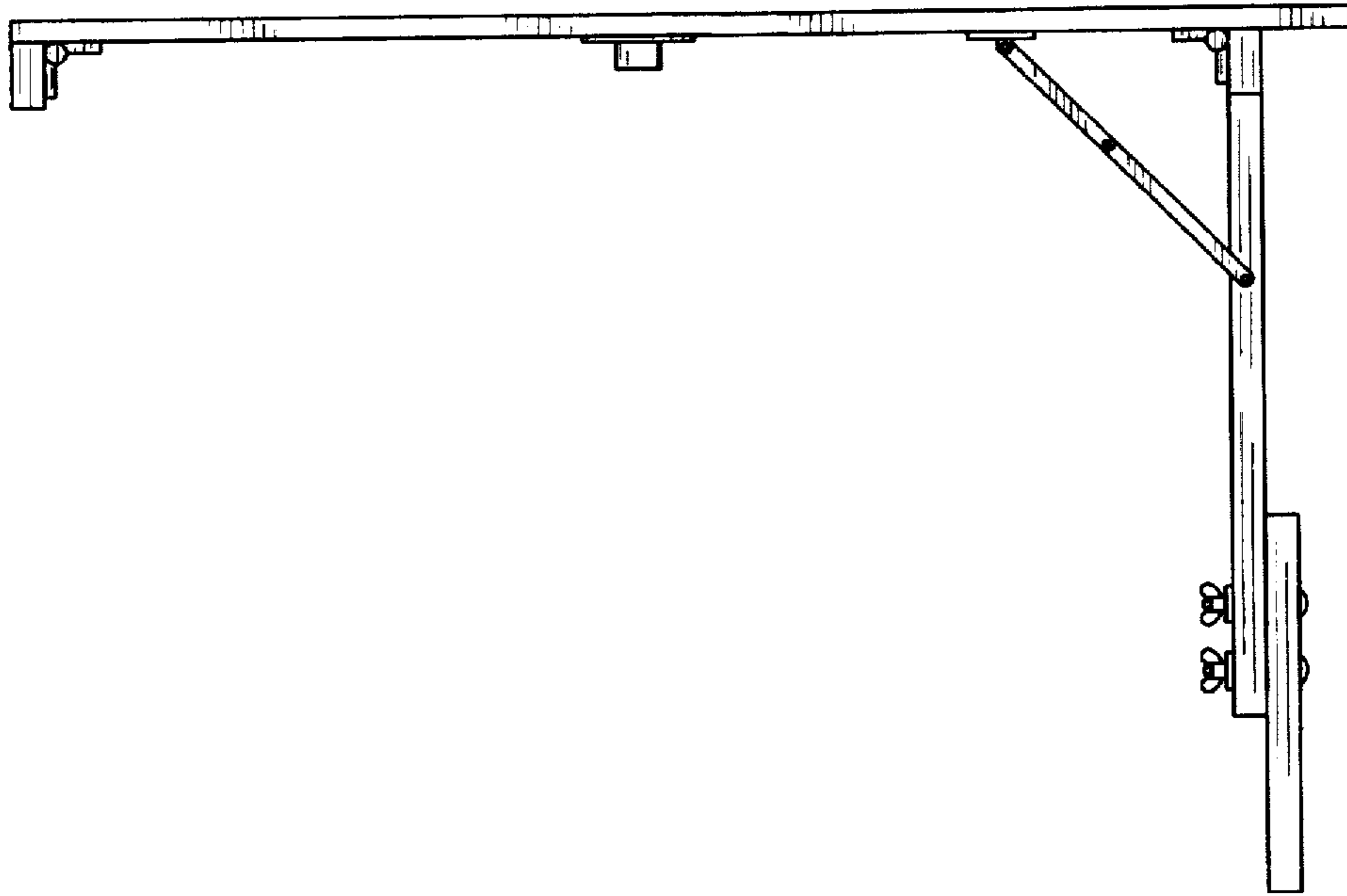

FIG. 2

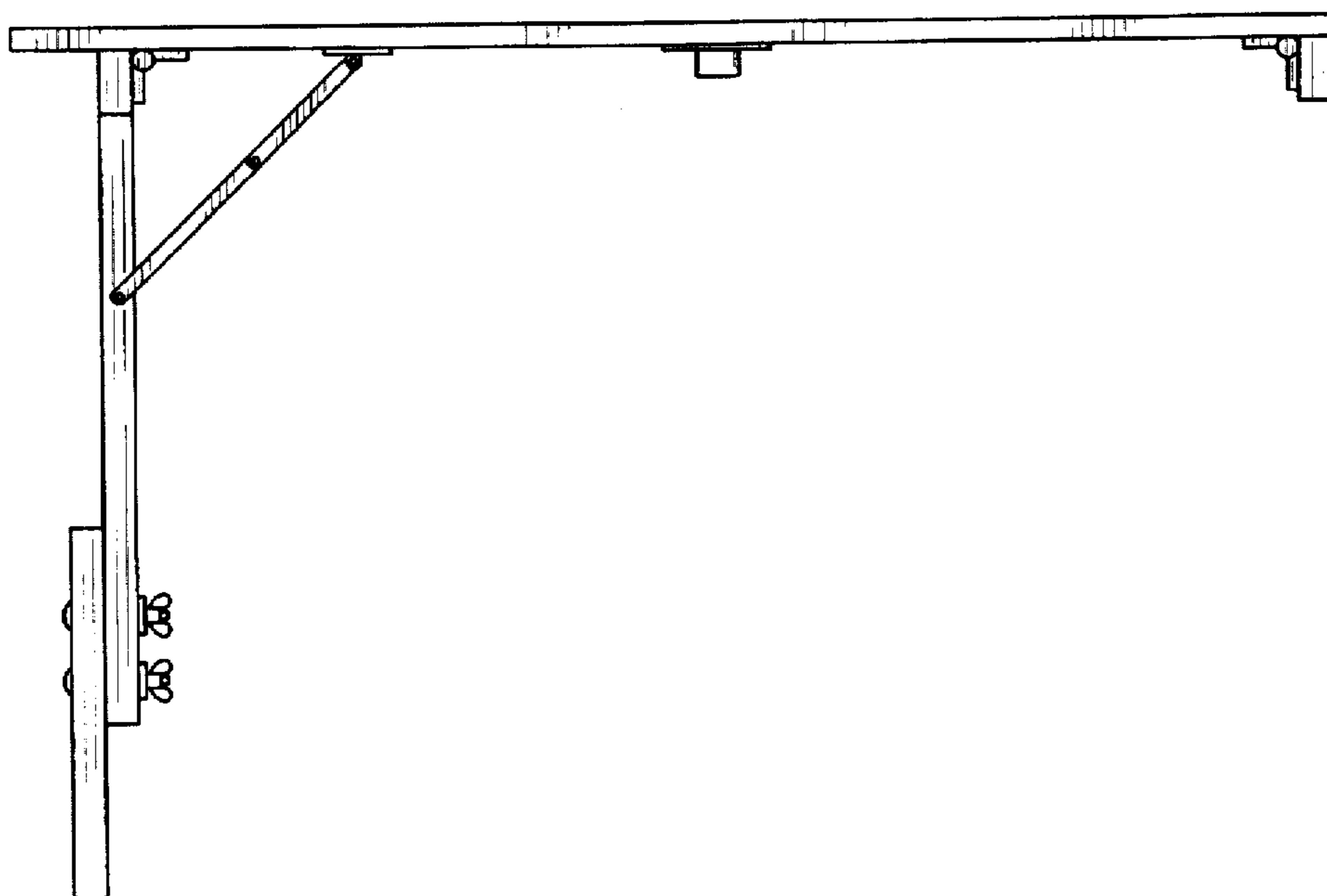

FIG. 3

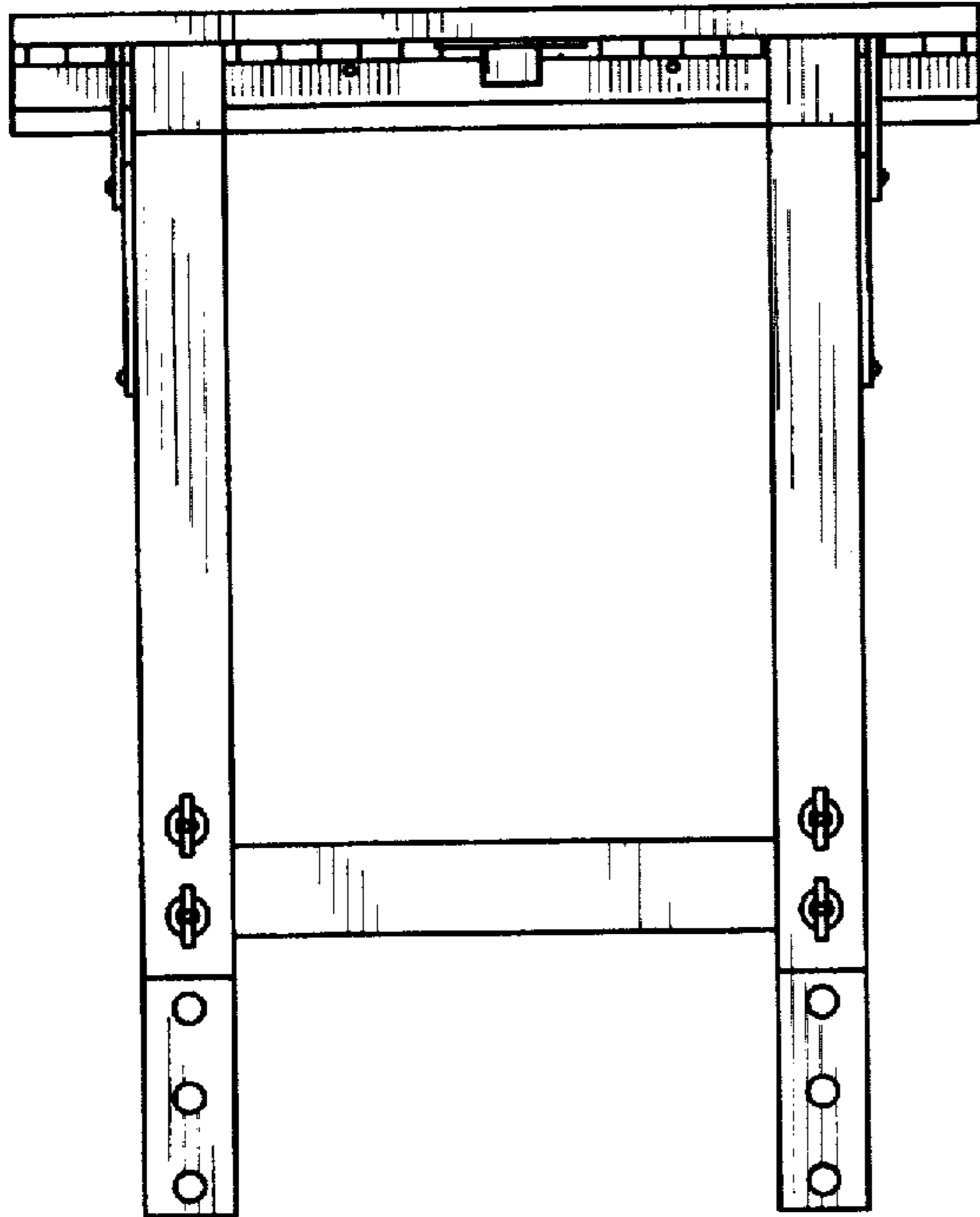

FIG. 4

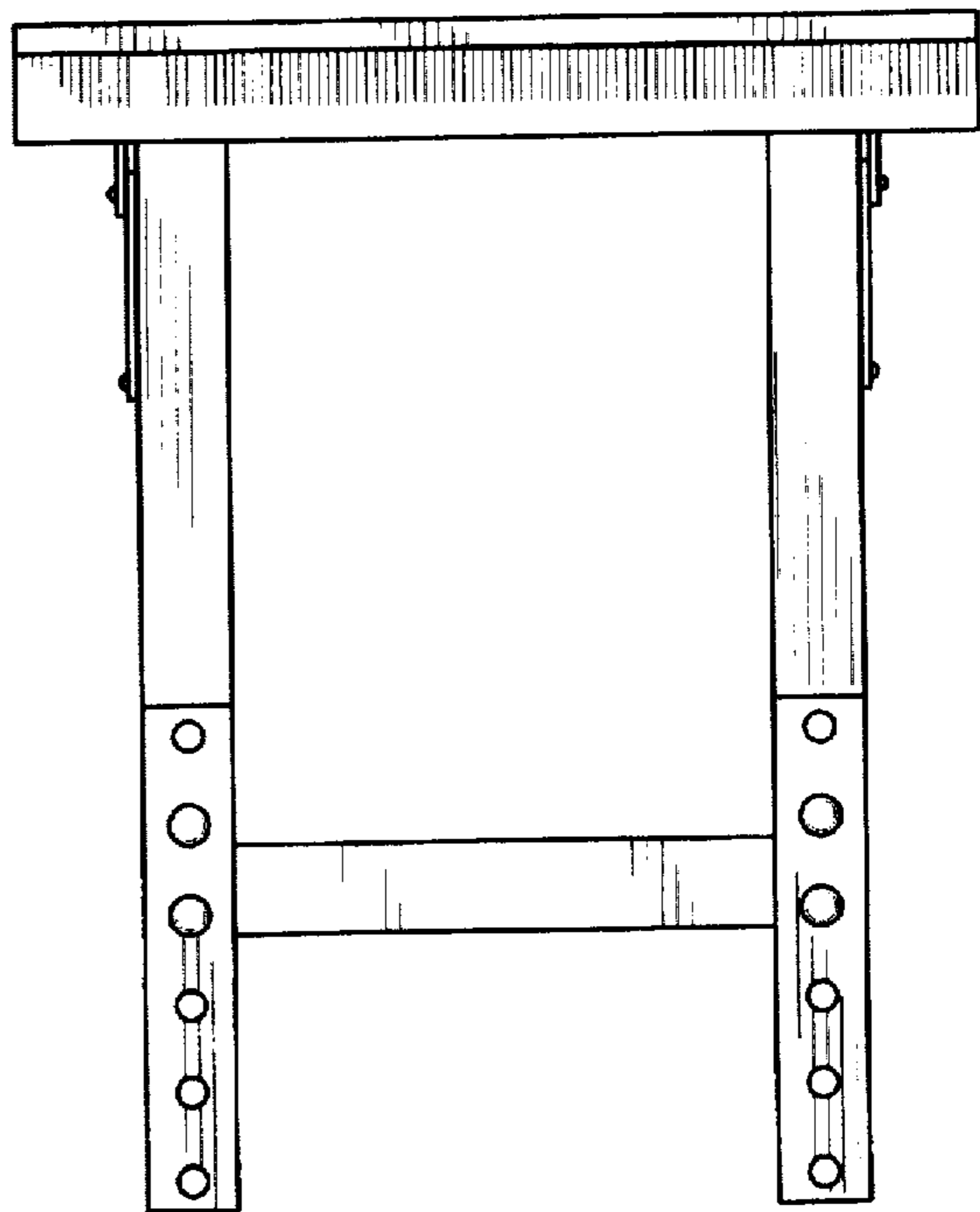

FIG. 5

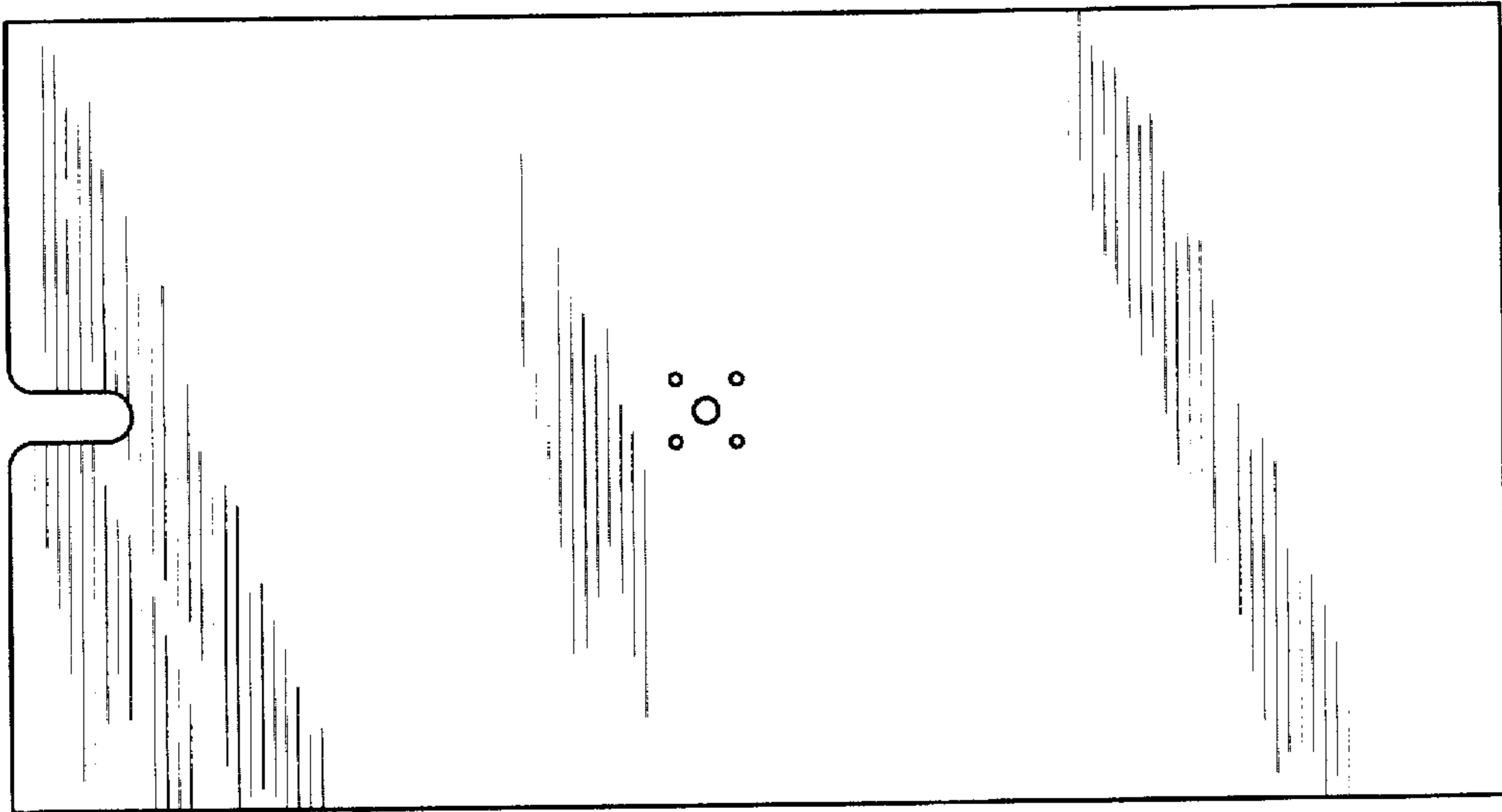

FIG. 6

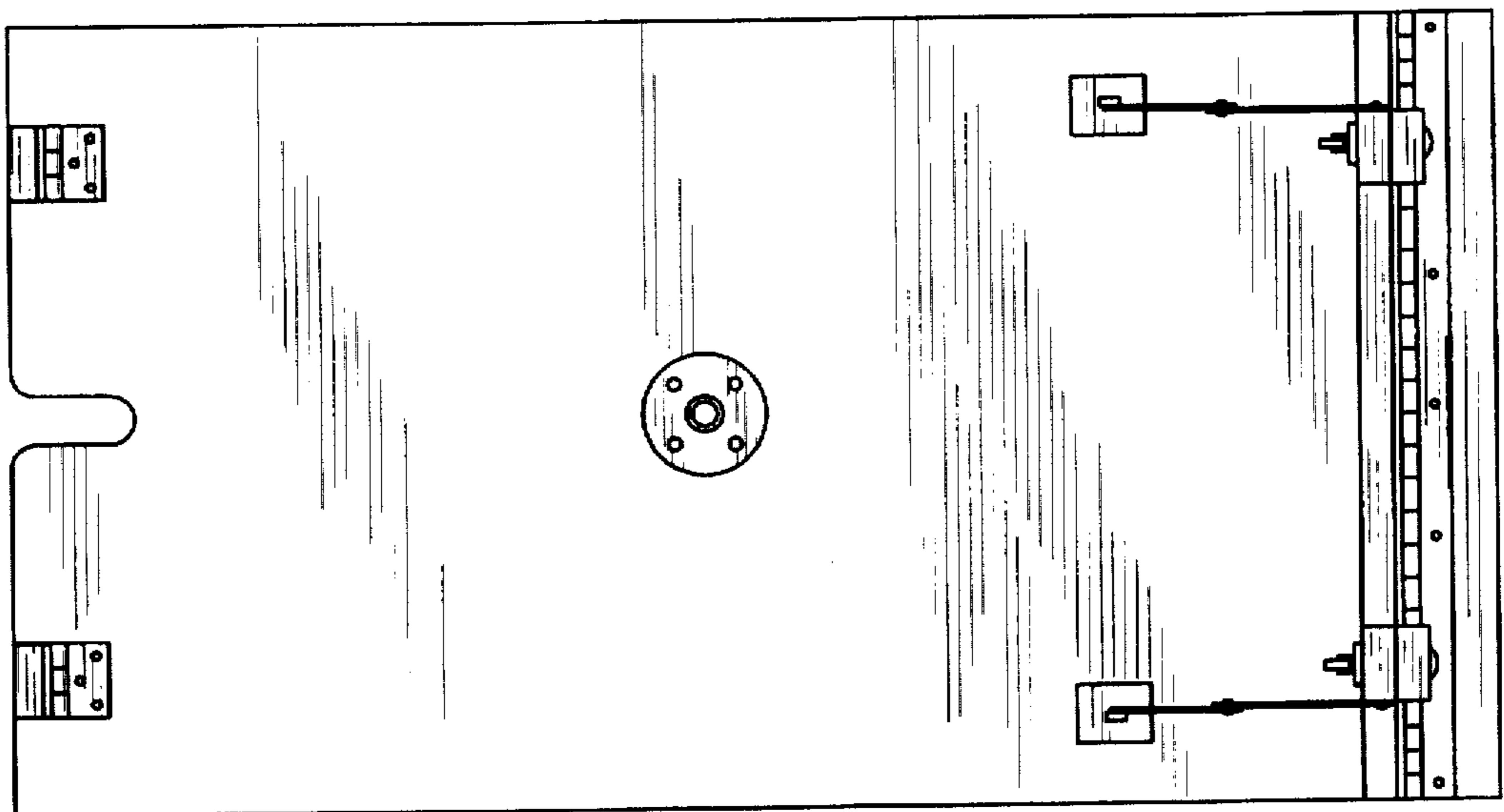

FIG. 7

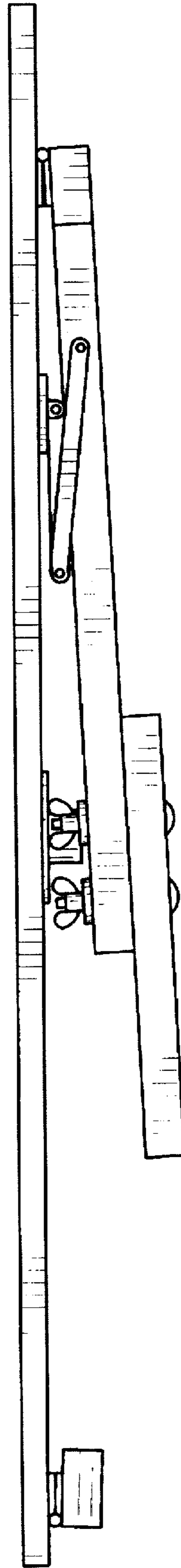

FIG. 8

