



US00D389370S

United States Patent [19]

[11] Patent Number: **Des. 389,370**

Lee

[45] Date of Patent: ****Jan. 20, 1998**

[54] **TEA POT**

[76] Inventor: **Jeff Lee**, No. 280, Yen-Ho St.,
Yung-Kang City, Tainan Hsien, Taiwan

[**] Term: **14 Years**

[21] Appl. No.: **67,599**

[22] Filed: **Mar. 11, 1997**

[51] **LOC (6) Cl.** **07-01**

[52] **U.S. Cl.** **D7/321; 7/302**

[58] **Field of Search** **D7/321, 312, 301,**
D7/302, 303, 318, 319; 222/473

[56] **References Cited**

U.S. PATENT DOCUMENTS

D. 149,962	6/1948	Mccarty	D7/321
D. 178,938	6/1956	Manning	D7/321 X
D. 352,861	11/1994	Shieh	D7/302
D. 357,158	4/1995	Lin	D7/302
D. 358,056	5/1995	Lin	D7/302

OTHER PUBLICATIONS

Bajazzo teakettle, (bottom), HFD, Mar. 1988, p. 78.
Teapot(left), Tableware International, Jul. 1975, p. 42.

Primary Examiner—M. N. Pandozzi
Attorney, Agent, or Firm—Curtis, Morris and Safford, P.C.

[57] **CLAIM**

The ornamental design for a tea pot, as shown and described.

DESCRIPTION

FIG. 1 is a perspective view of tea pot showing my new design;

FIG. 2 is a front elevational view thereof;

FIG. 3 is a rear elevational view thereof;

FIG. 4 is a left side elevational view thereof;

FIG. 5 is a right side elevational view thereof;

FIG. 6 is a top plan view thereof; and,

FIG. 7 is a bottom plan view thereof.

1 Claim, 4 Drawing Sheets

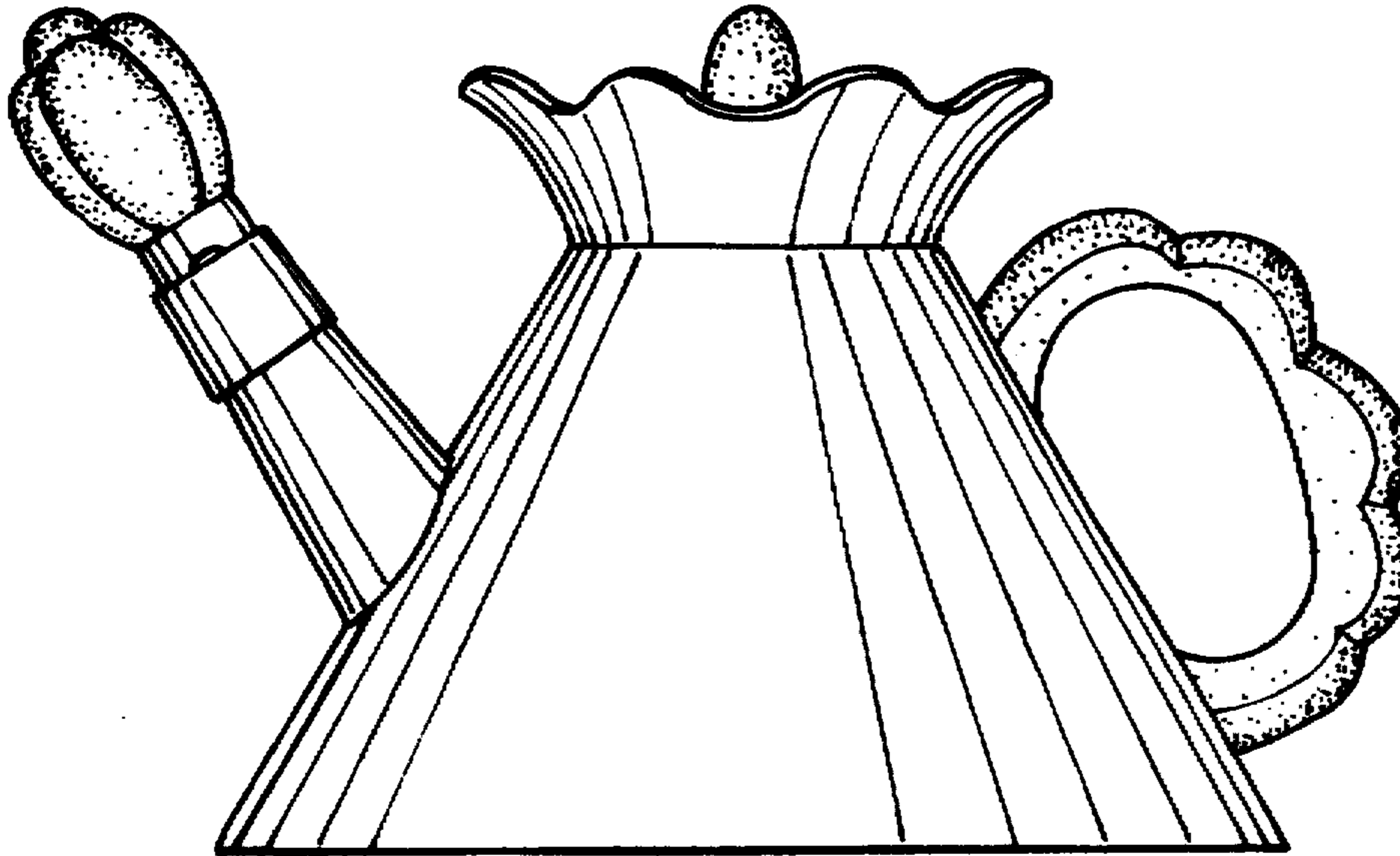

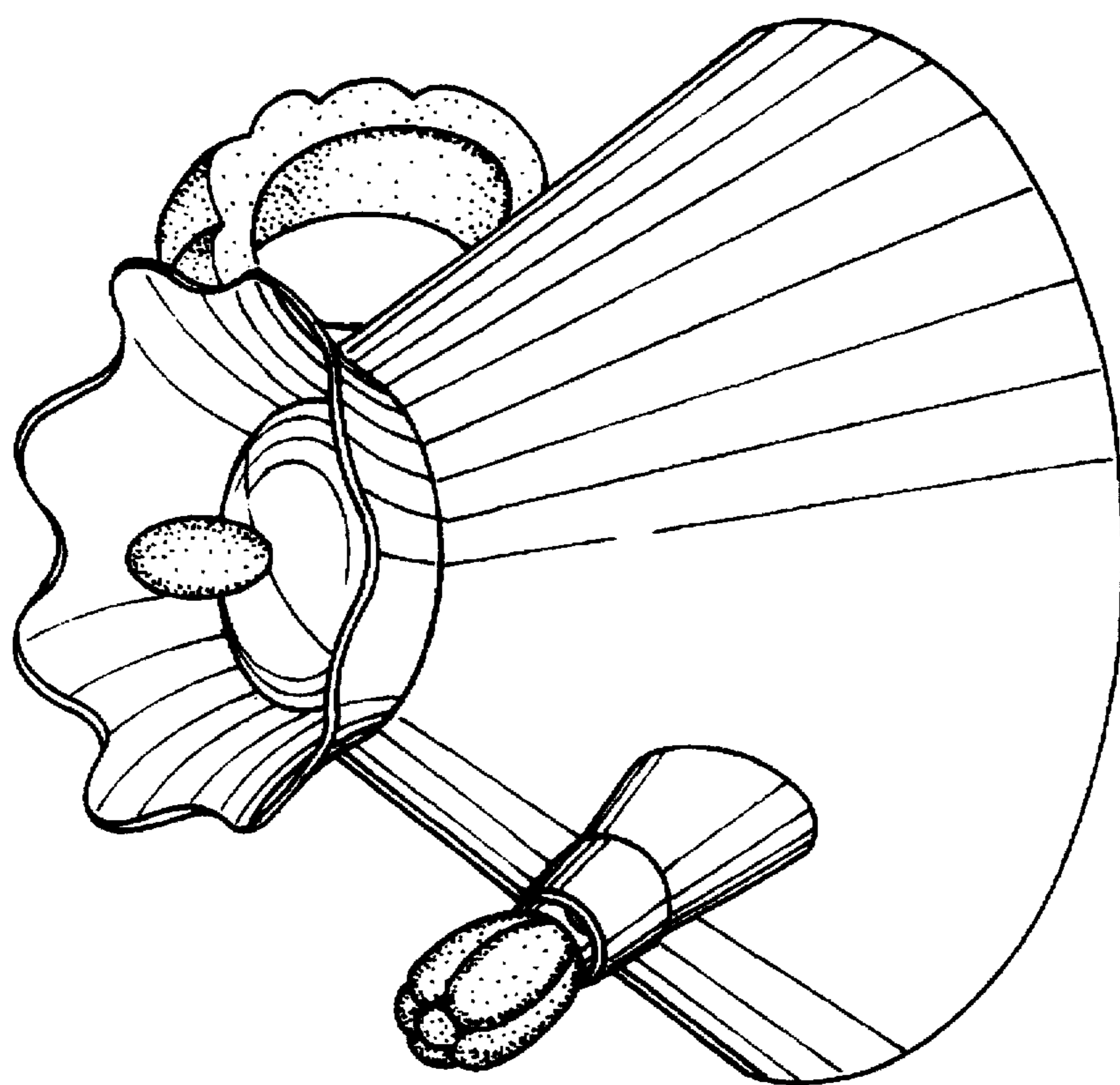

FIG. 1

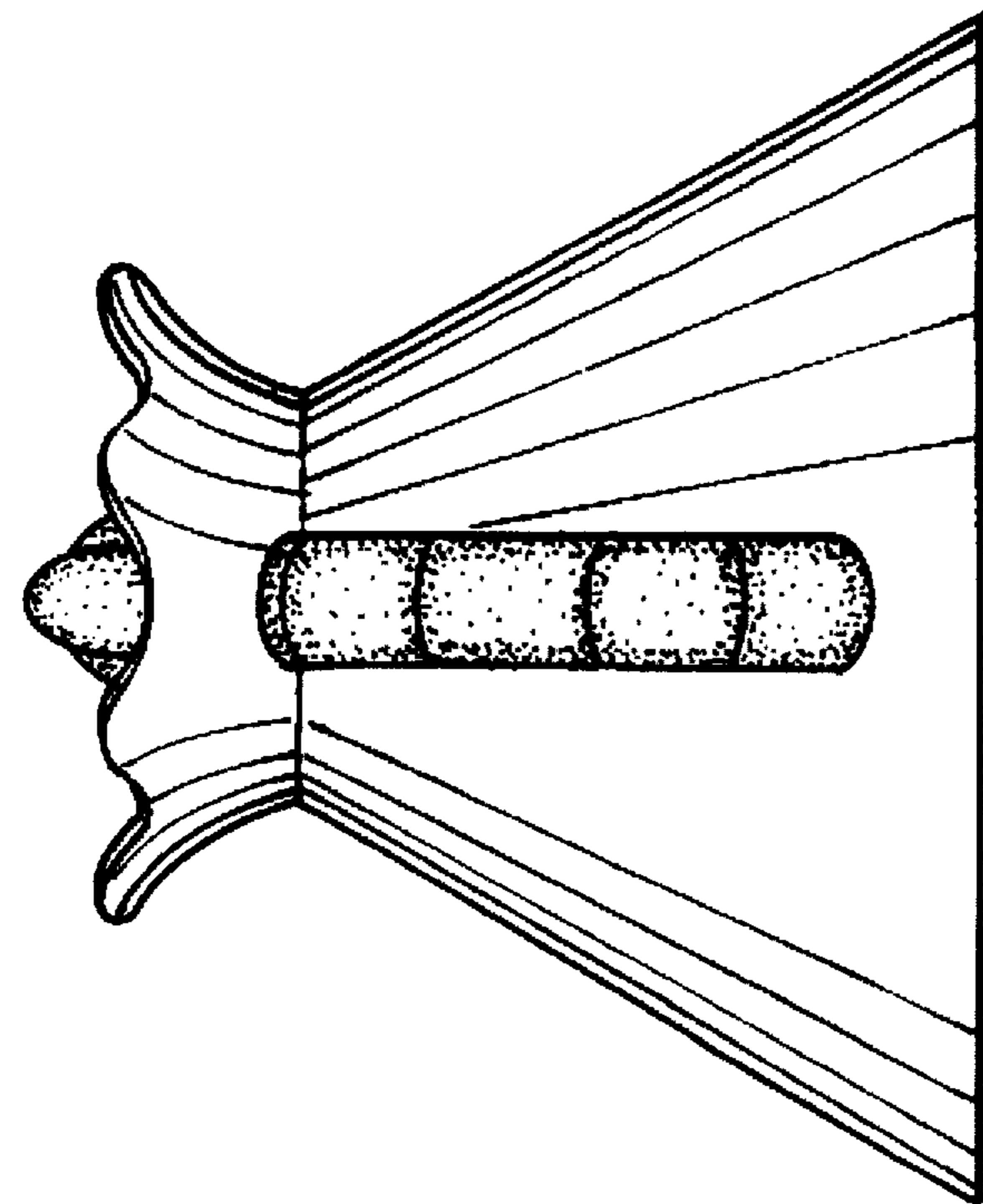

FIG. 2

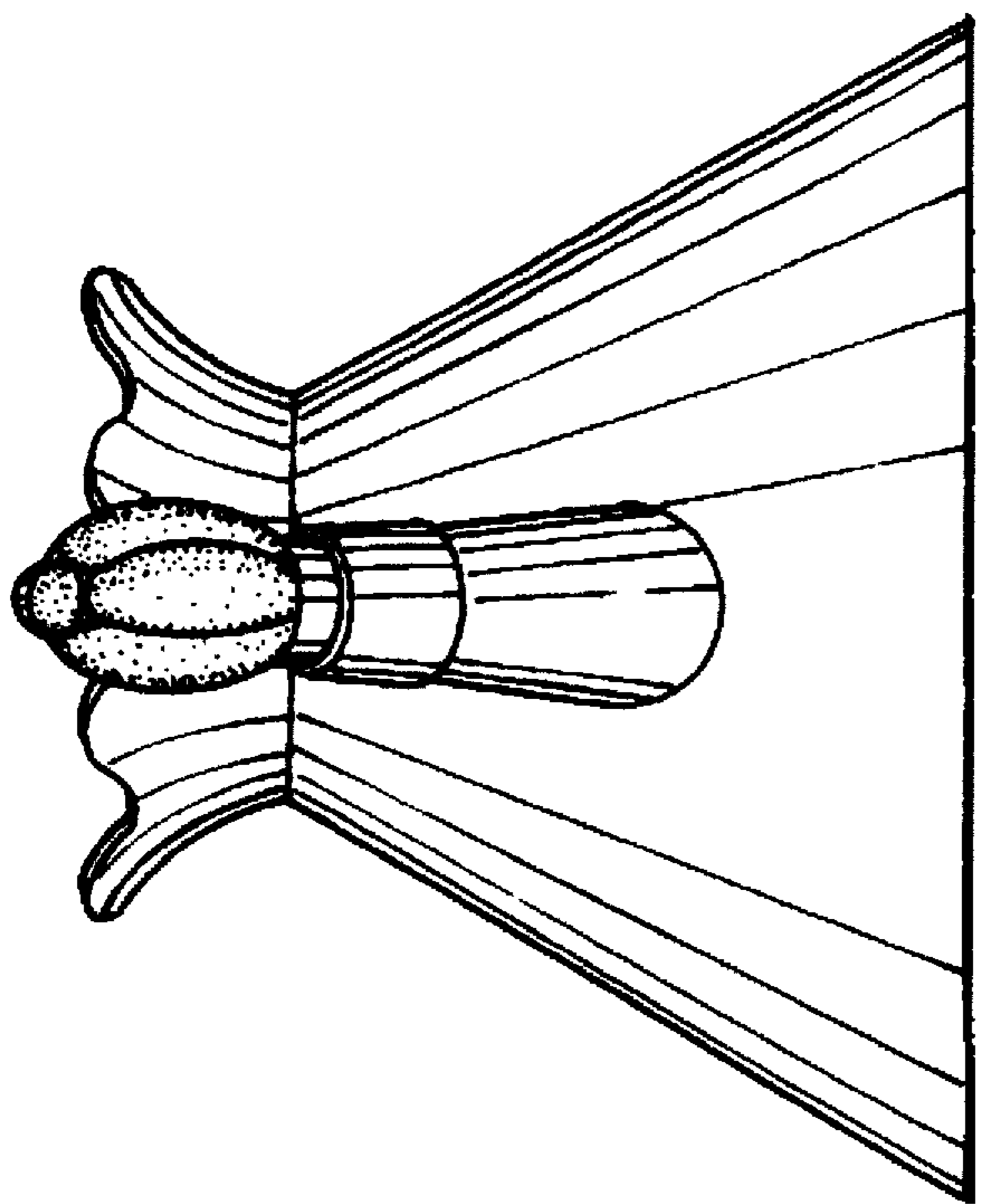

FIG. 3

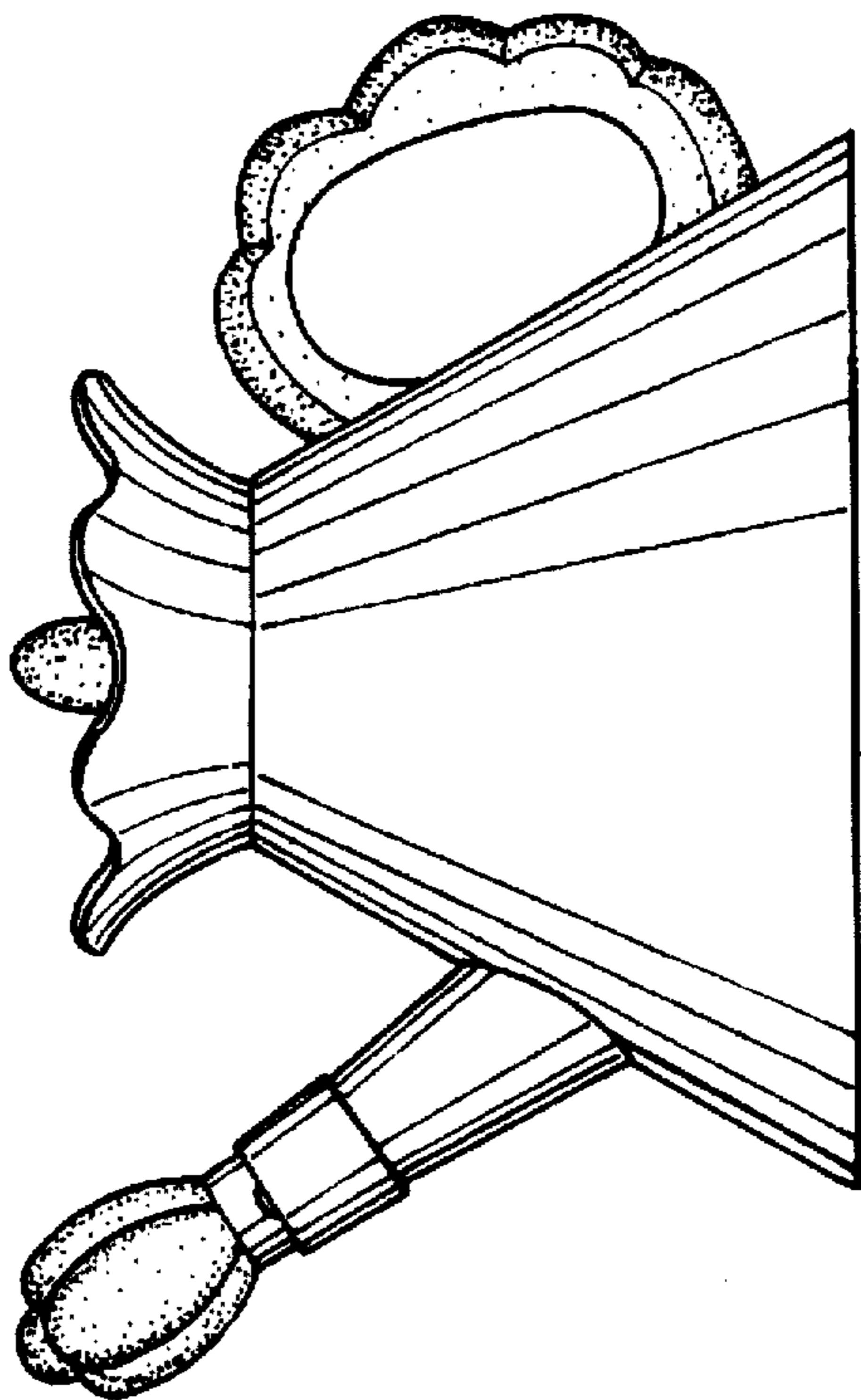

FIG. 5

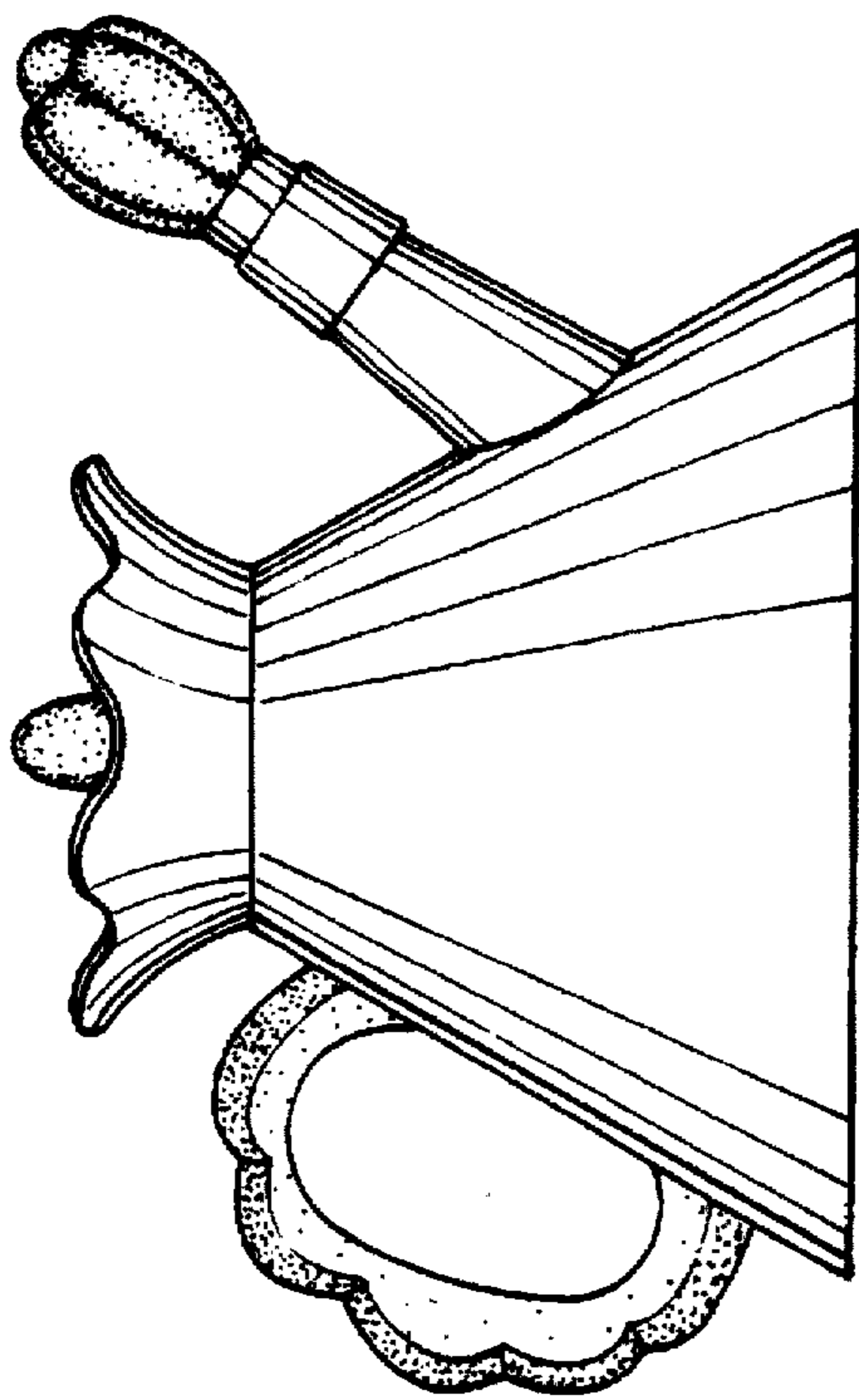

FIG. 4

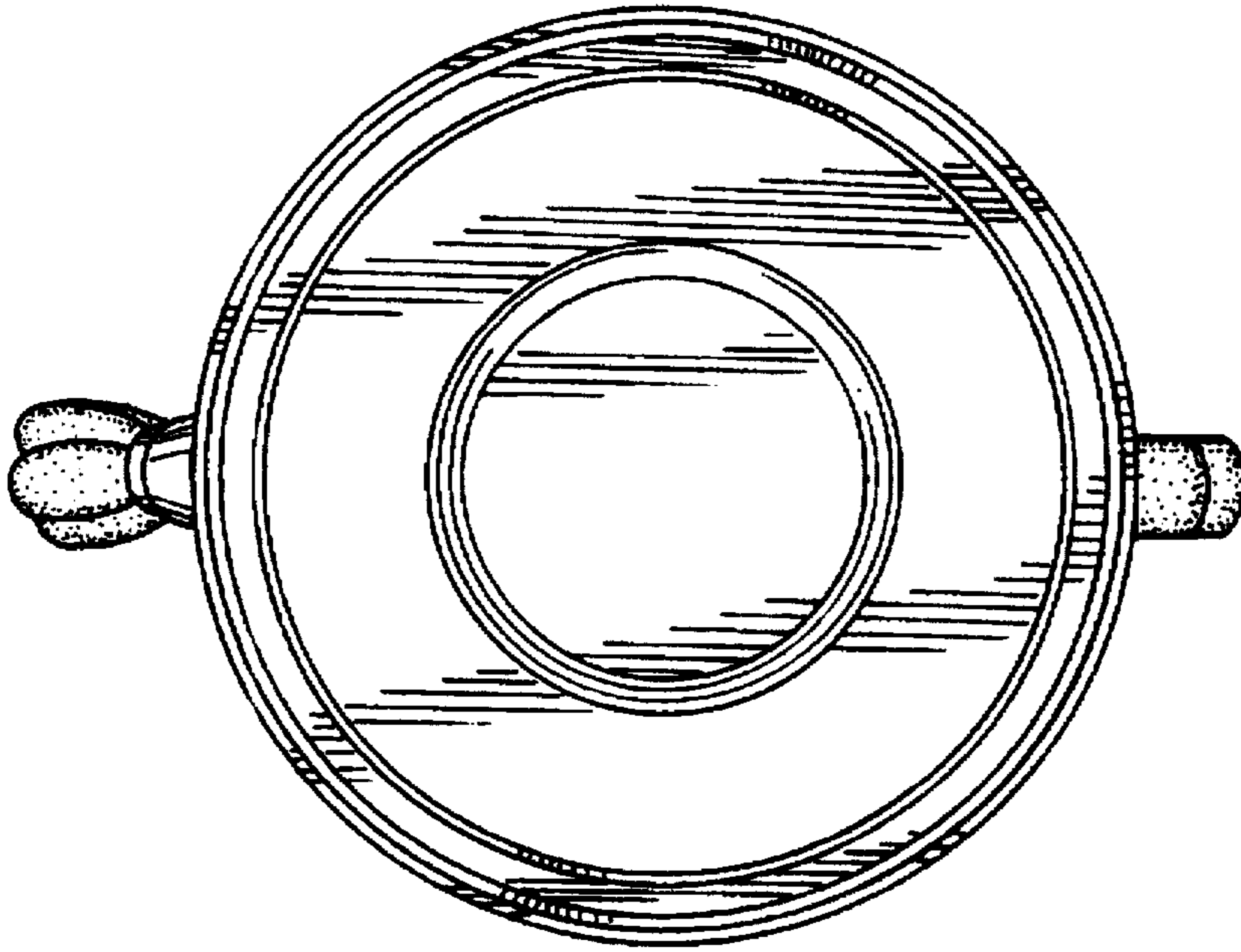

FIG. 7

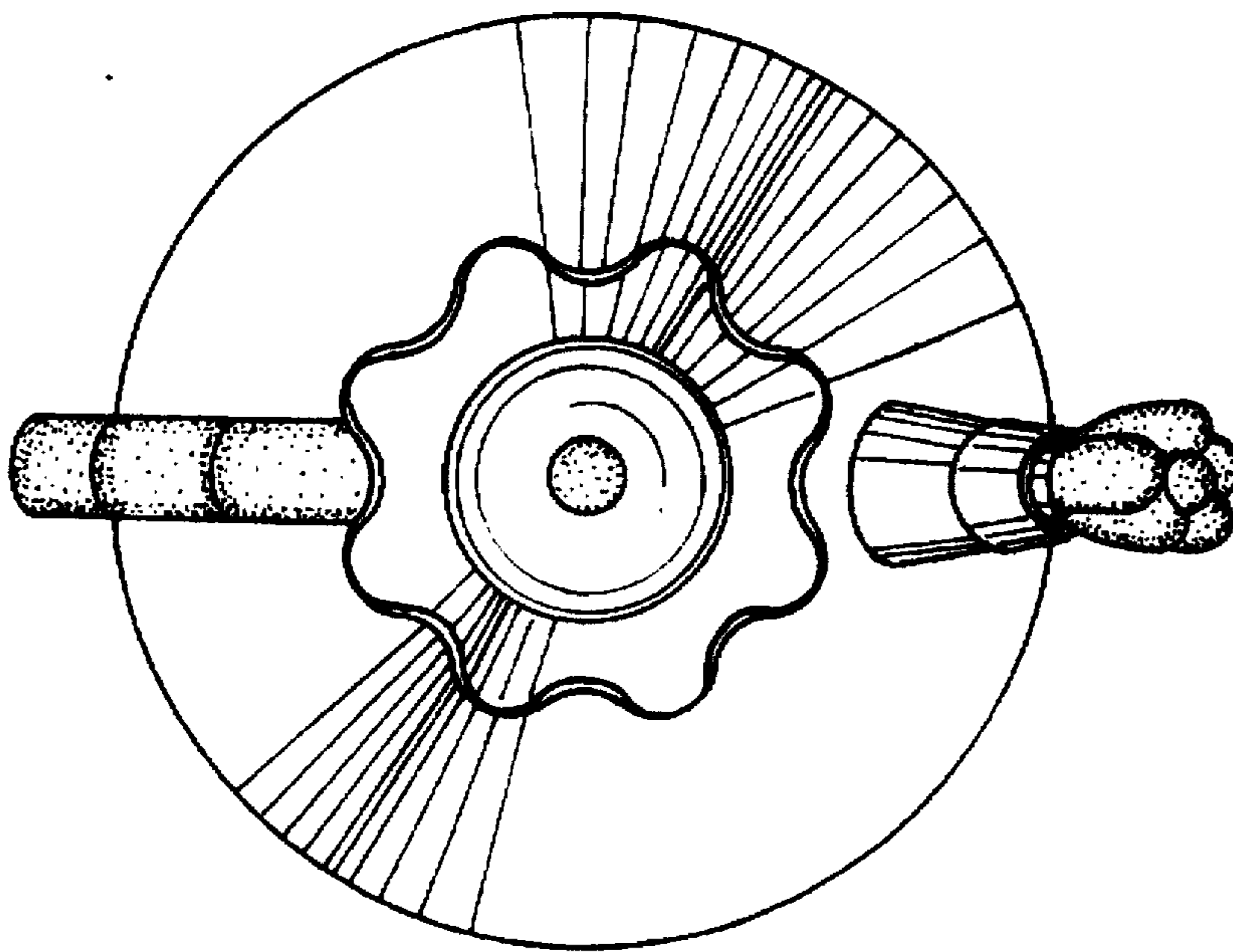

FIG. 6