

US00D389366S

United States Patent [19]
Lipson

[11] **Patent Number: Des. 389,366**

[45] **Date of Patent: **Jan. 20, 1998**

[54] **STRAW**

[75] **Inventor: Erik Lipson, Philadelphia, Pa.**

[73] **Assignee: Fun-Time International, Inc., Philadelphia, Pa.**

[**] **Term: 14 Years**

[21] **Appl. No.: 60,185**

[22] **Filed: Sep. 24, 1996**

[51] **LOC (6) Cl. 07-06**

[52] **U.S. Cl. D7/300.2**

[58] **Field of Search D7/300.2; D8/499; D21/61; 446/15; 239/33; 215/229, 388; D18/24, 26**

[56] **References Cited**

U.S. PATENT DOCUMENTS

D. 200,078	1/1965	Miller, Jr. et al.	D18/24
D. 217,216	4/1970	Cohen	D7/300.2
D. 220,238	3/1971	Bernstein	D7/300.2
D. 330,141	10/1992	McNerney et al.	D7/300.2
D. 378,684	4/1997	Duppins	D18/26

Primary Examiner—Terry A. Wallace
Attorney, Agent, or Firm—Gifford, Krass, Groh, Sprinkle, Patmore, Anderson & Citkowski, P.C.

[57] **CLAIM**

The ornamental design for straw, as shown.

DESCRIPTION

FIG. 1 is a front view of a first embodiment of the straw; FIG. 2 is a right side view of the straw of FIG. 1; FIG. 3 is a rear side view of the straw of FIG. 1; FIG. 4 is a left side view of the straw of FIG. 1; FIG. 5 is an top plan view of the straw of FIG. 1; FIG. 6 is a bottom view of the straw of FIG. 1; FIG. 7 is a front view of a second embodiment of the straw; FIG. 8 is a right side view of the straw of FIG. 7; FIG. 9 is a rear side view of the straw of FIG. 7; FIG. 10 is a left side view of the straw of FIG. 7; FIG. 11 is a top plan view of the straw of FIG. 7; FIG. 12, is a bottom view of the straw of FIG. 7; FIG. 13 is a front view of a third embodiment of the straw; FIG. 14 is a right side view of the straw of FIG. 13; FIG. 15 is a rear side view of the straw of FIG. 13; FIG. 16 is a left side view of the straw of FIG. 13; FIG. 17 is a top plan view of the straw of FIG. 13; FIG. 18 is a bottom view of the straw of FIG. 13; FIG. 19 is a front view of a fourth embodiment of the straw; FIG. 20 is a right side view of the straw of FIG. 19; FIG. 21 is a rear side view of the straw of FIG. 19; FIG. 22 is a left side view of the straw of FIG. 19; FIG. 23 is a top plan view of the straw of FIG. 19; FIG. 24 is a bottom view of the straw of FIG. 19; FIG. 25 is a front view of a fifth embodiment of the straw; FIG. 26 is a right side view of the straw of FIG. 25; FIG. 27 is a rear side view of the straw of FIG. 25; FIG. 28 is a left side view of the straw of FIG. 25; FIG. 29 is a top plan view of the straw of FIG. 25; and, FIG. 30 is a bottom view of the straw of FIG. 25.

1 Claim, 5 Drawing Sheets

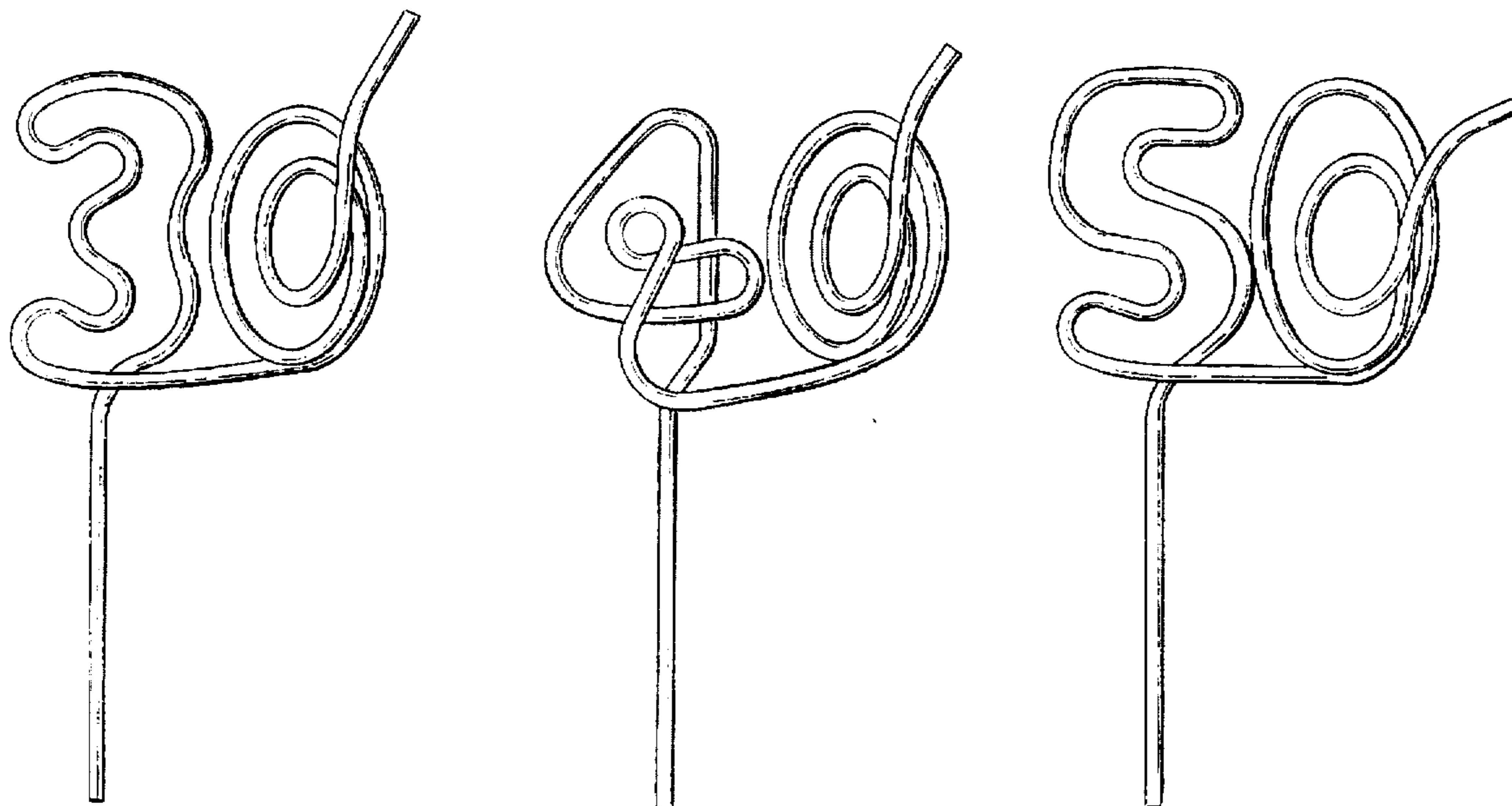

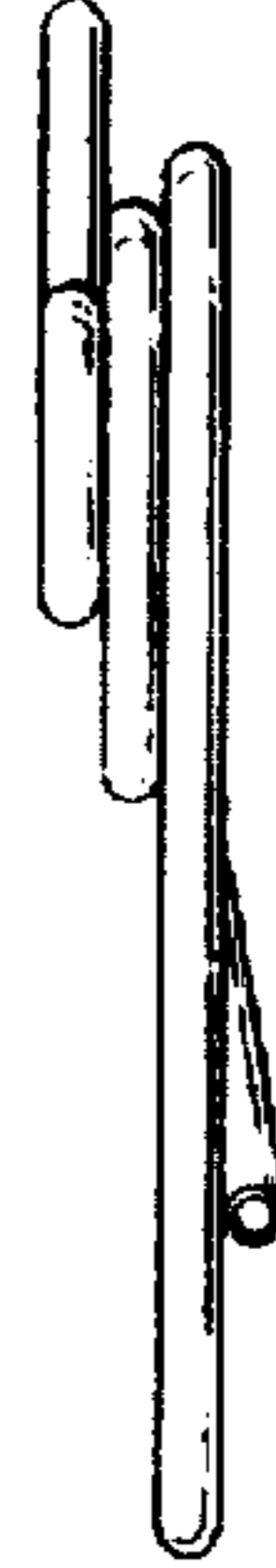
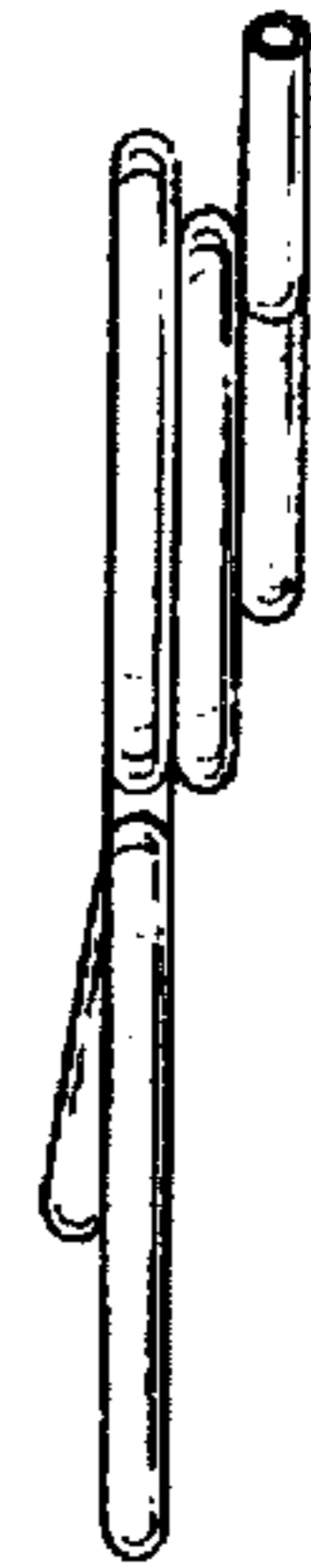
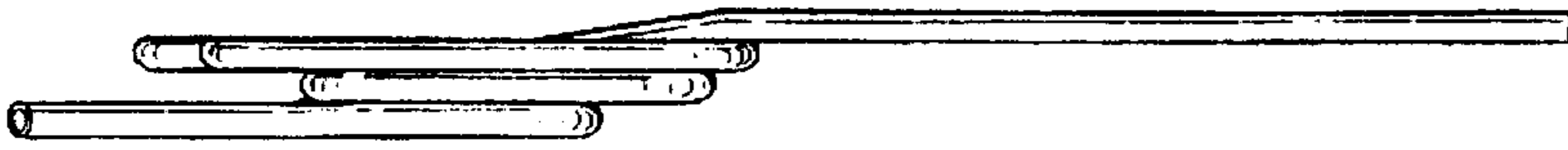
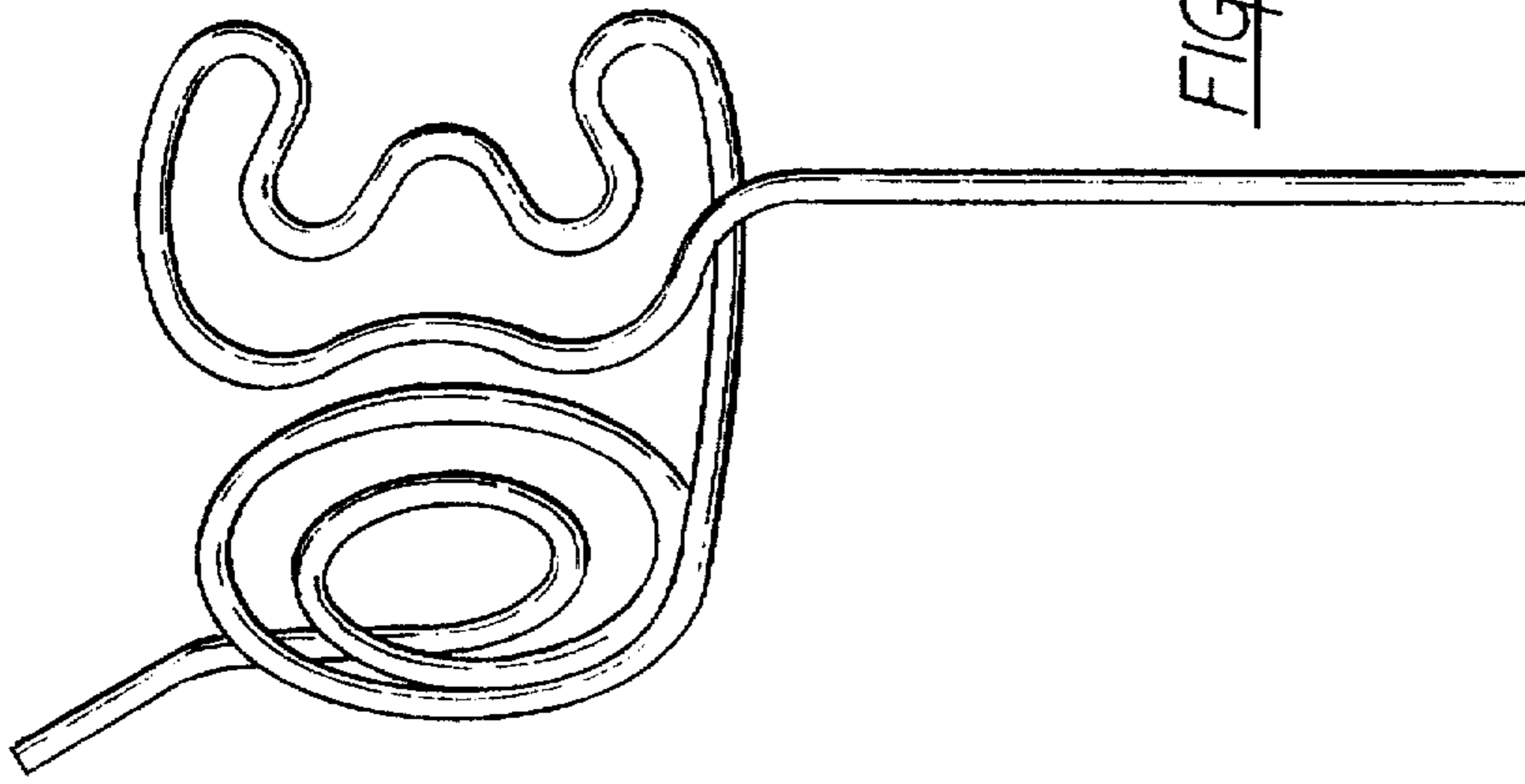
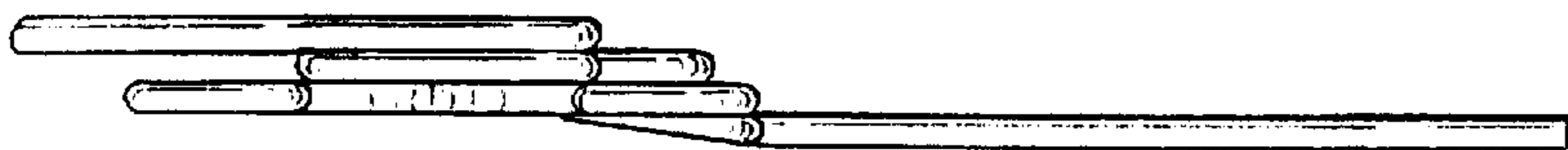
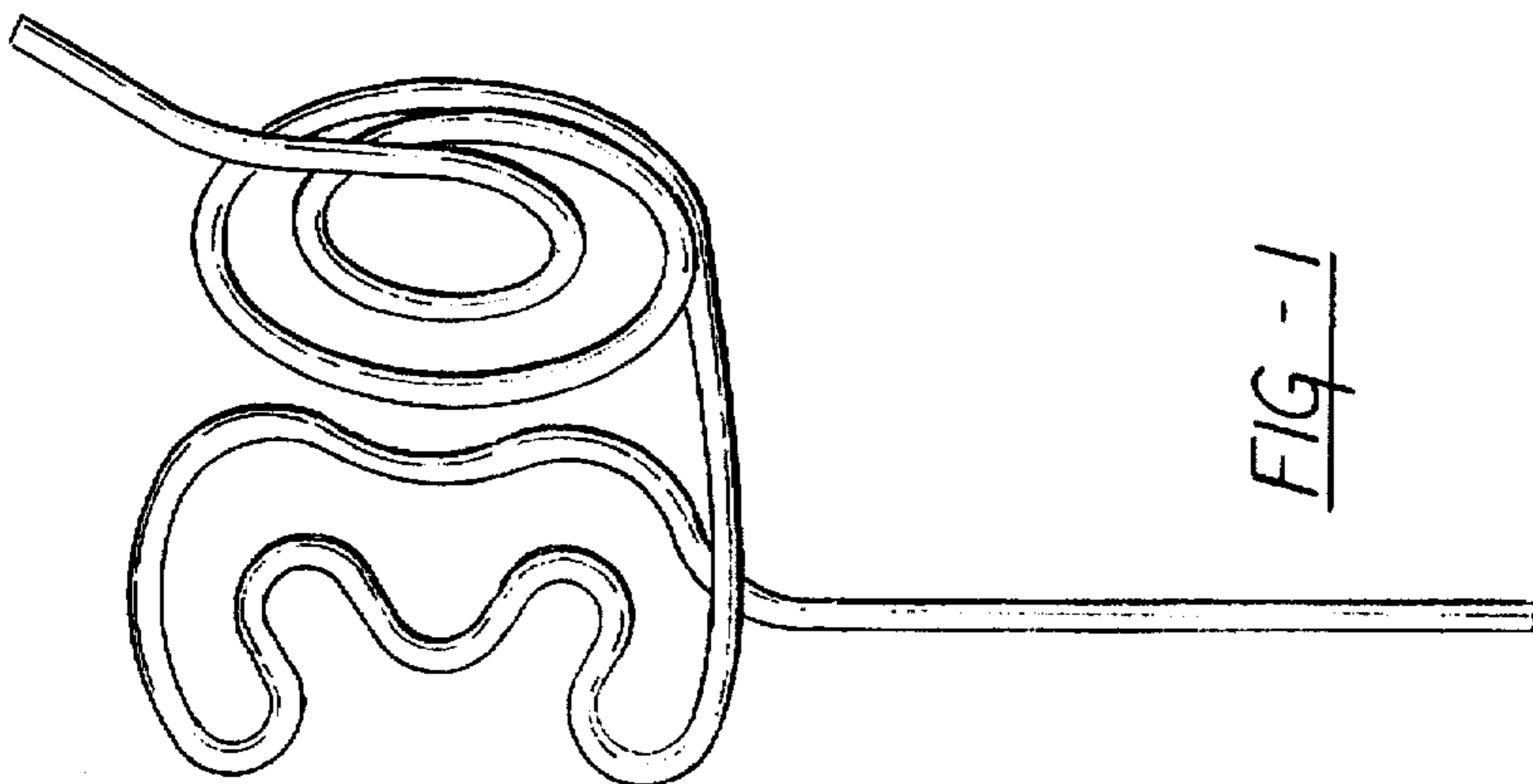

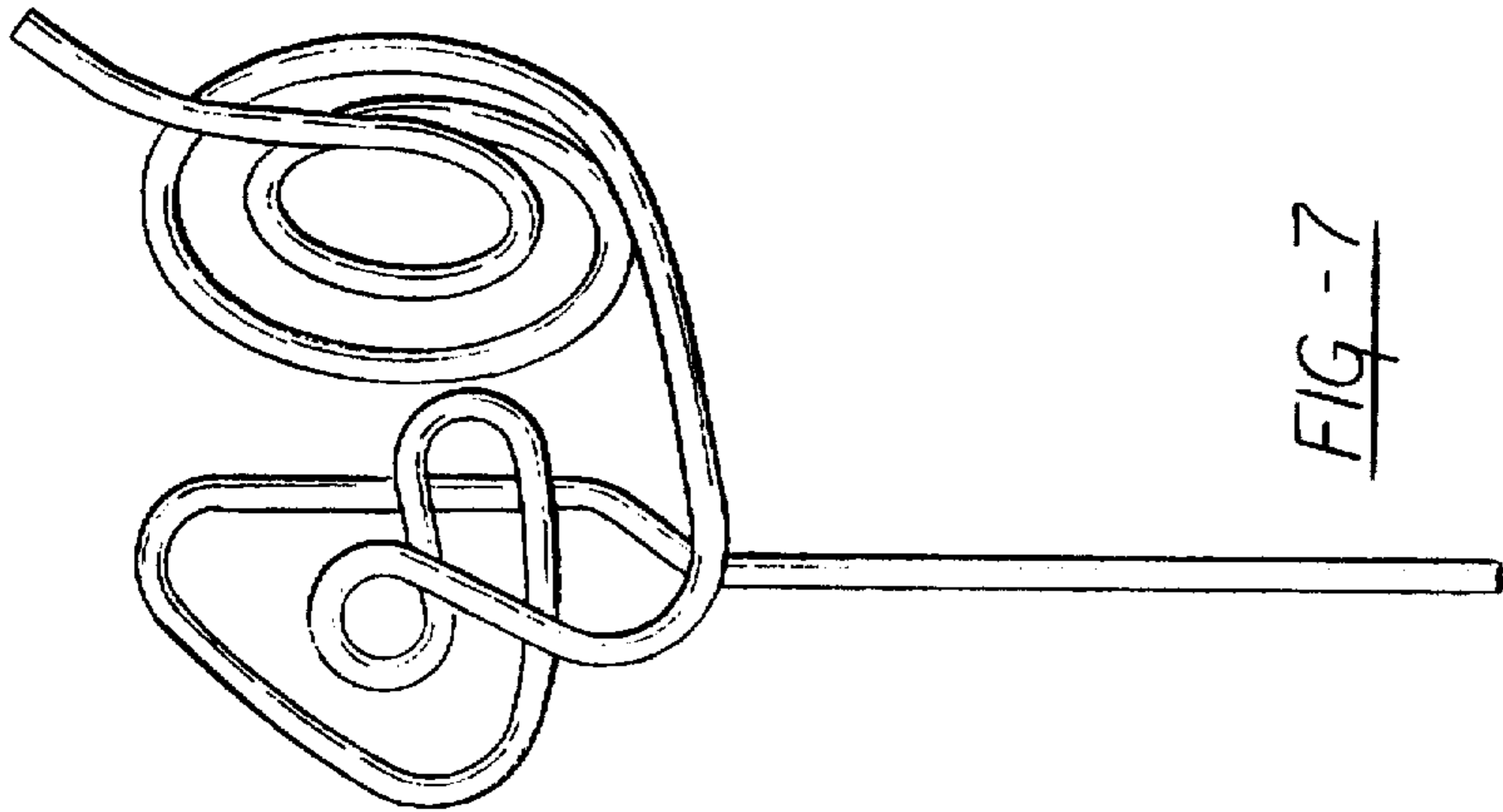

FIG - 7

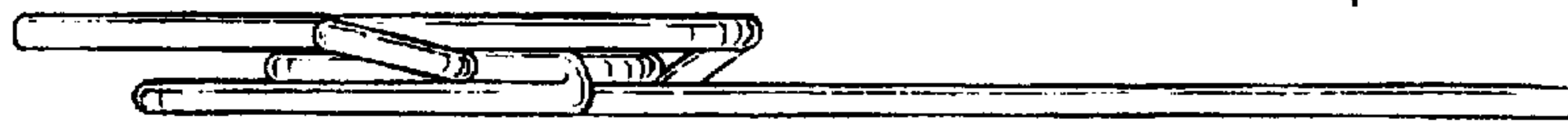

FIG - 8

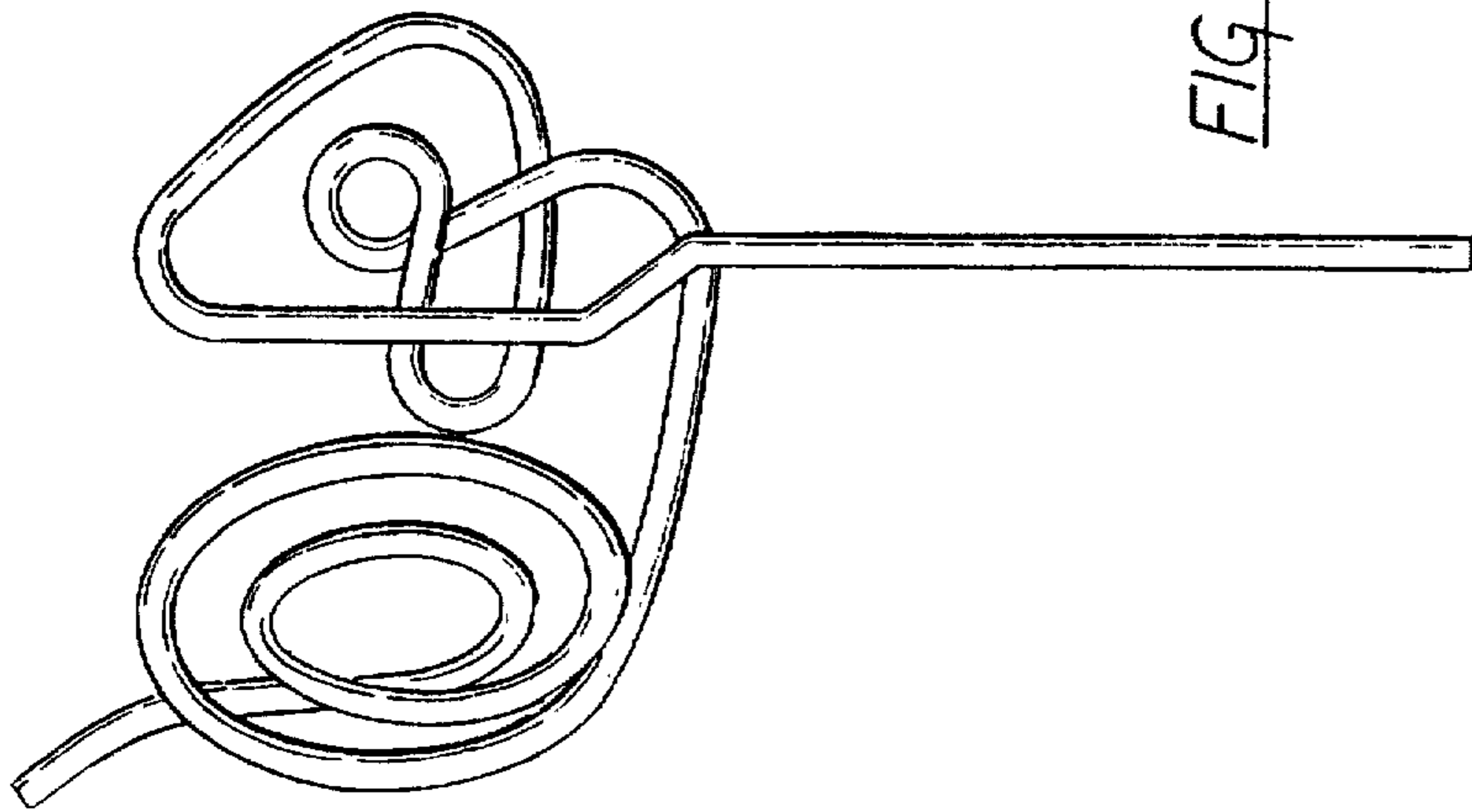

FIG - 9



FIG - 12

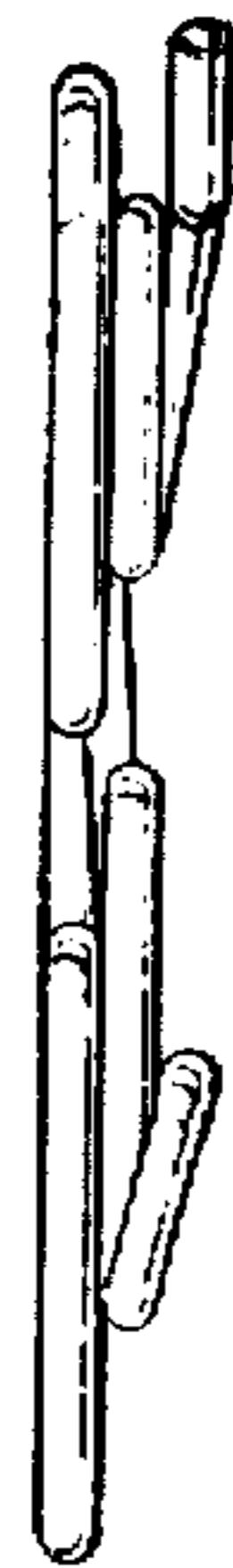

FIG - 10



FIG - 11

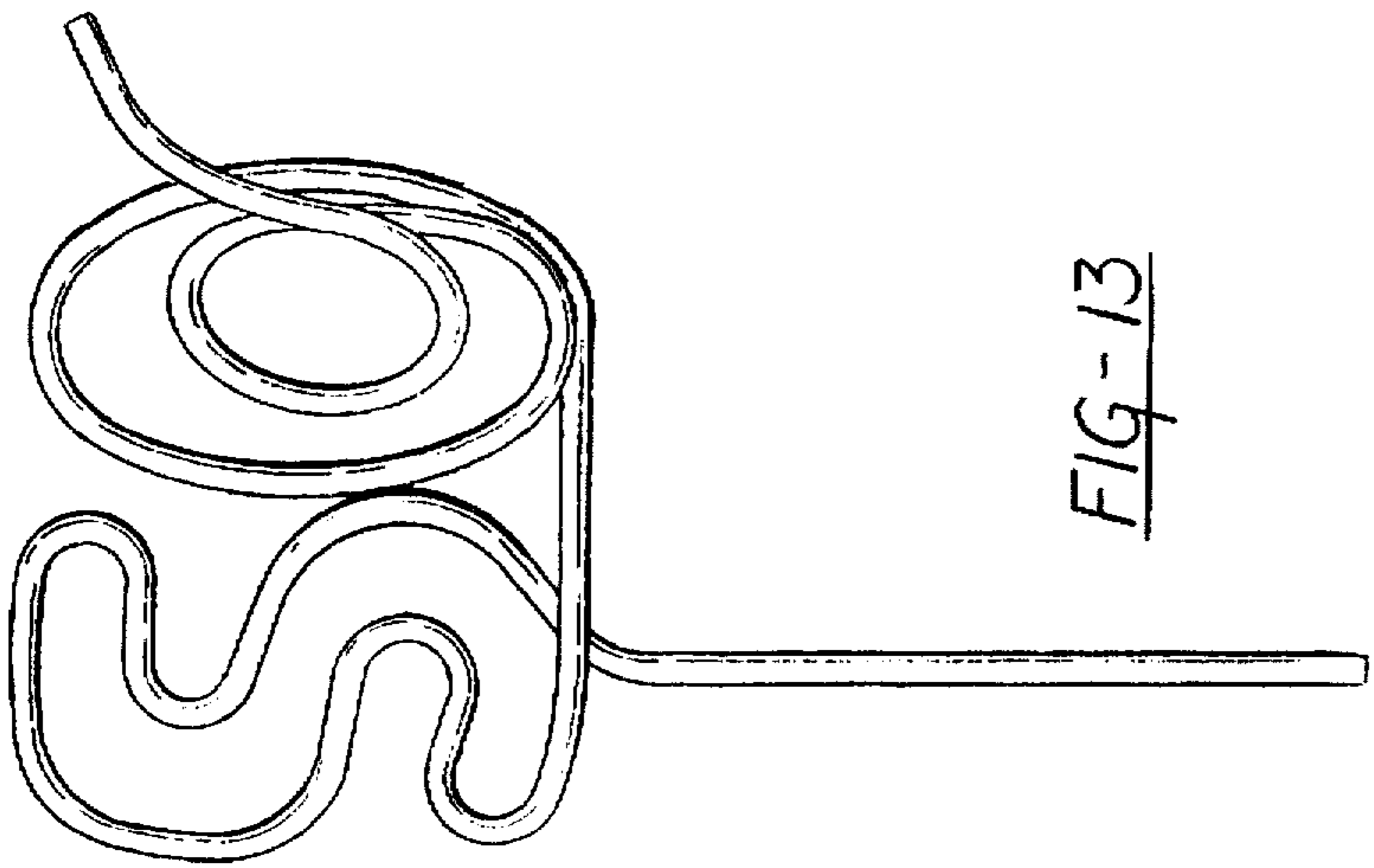

FIG-13

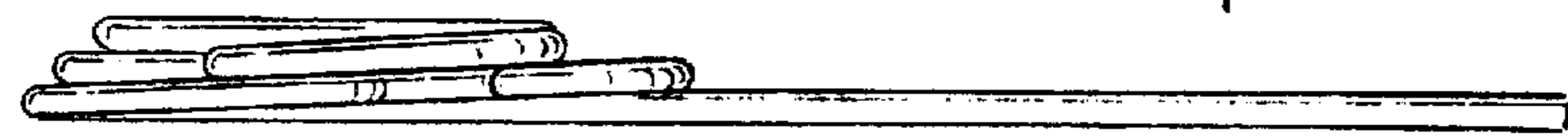

FIG-14

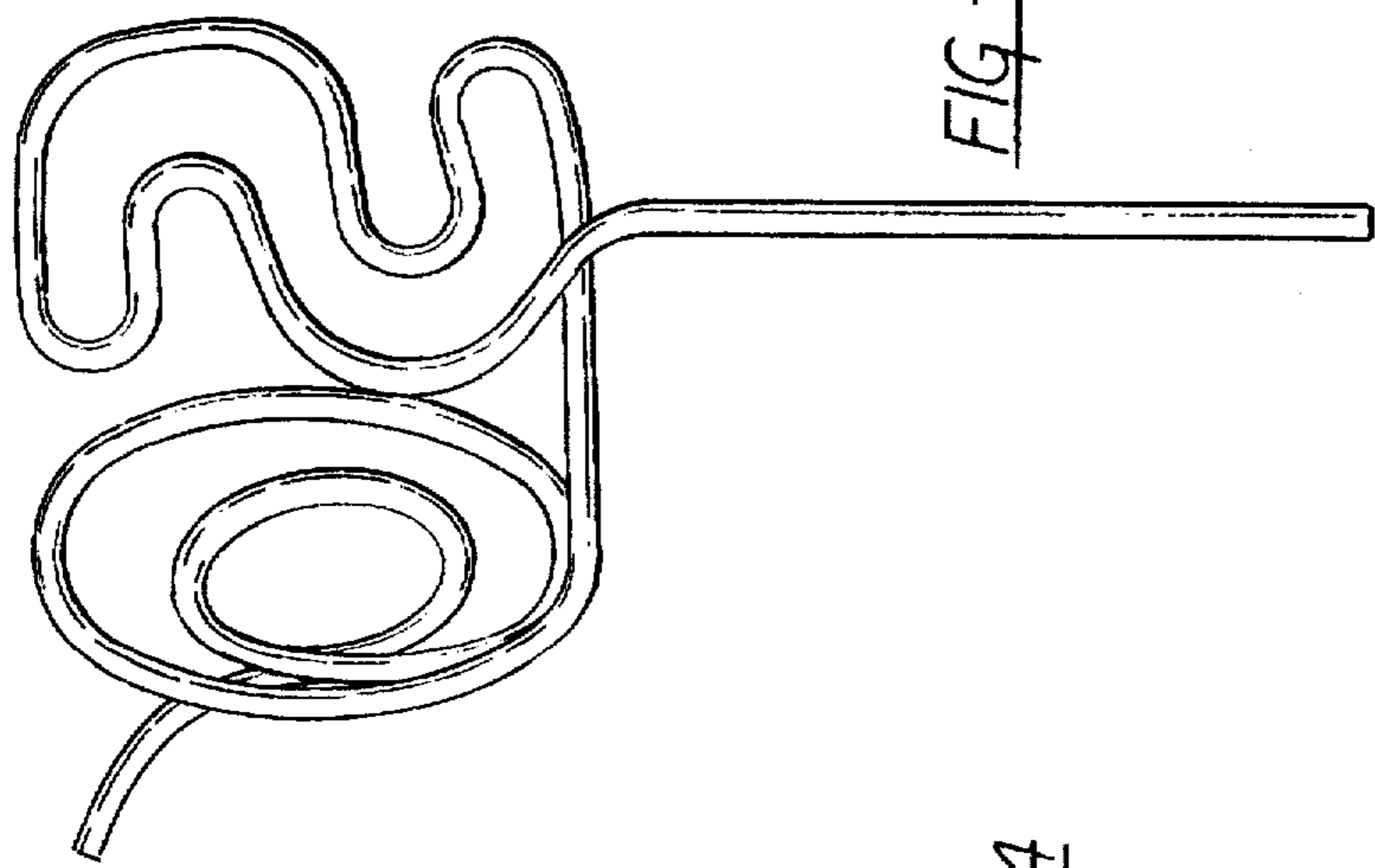

FIG-15

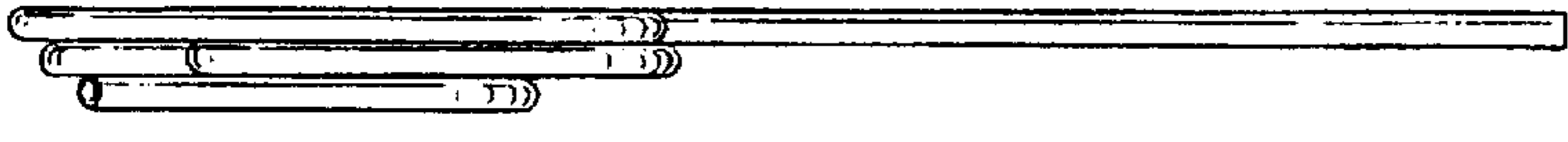

FIG-16

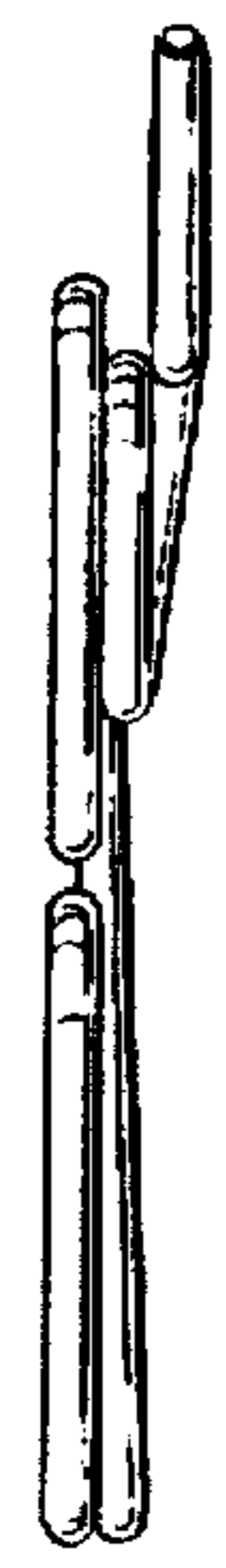

FIG-17



FIG-18

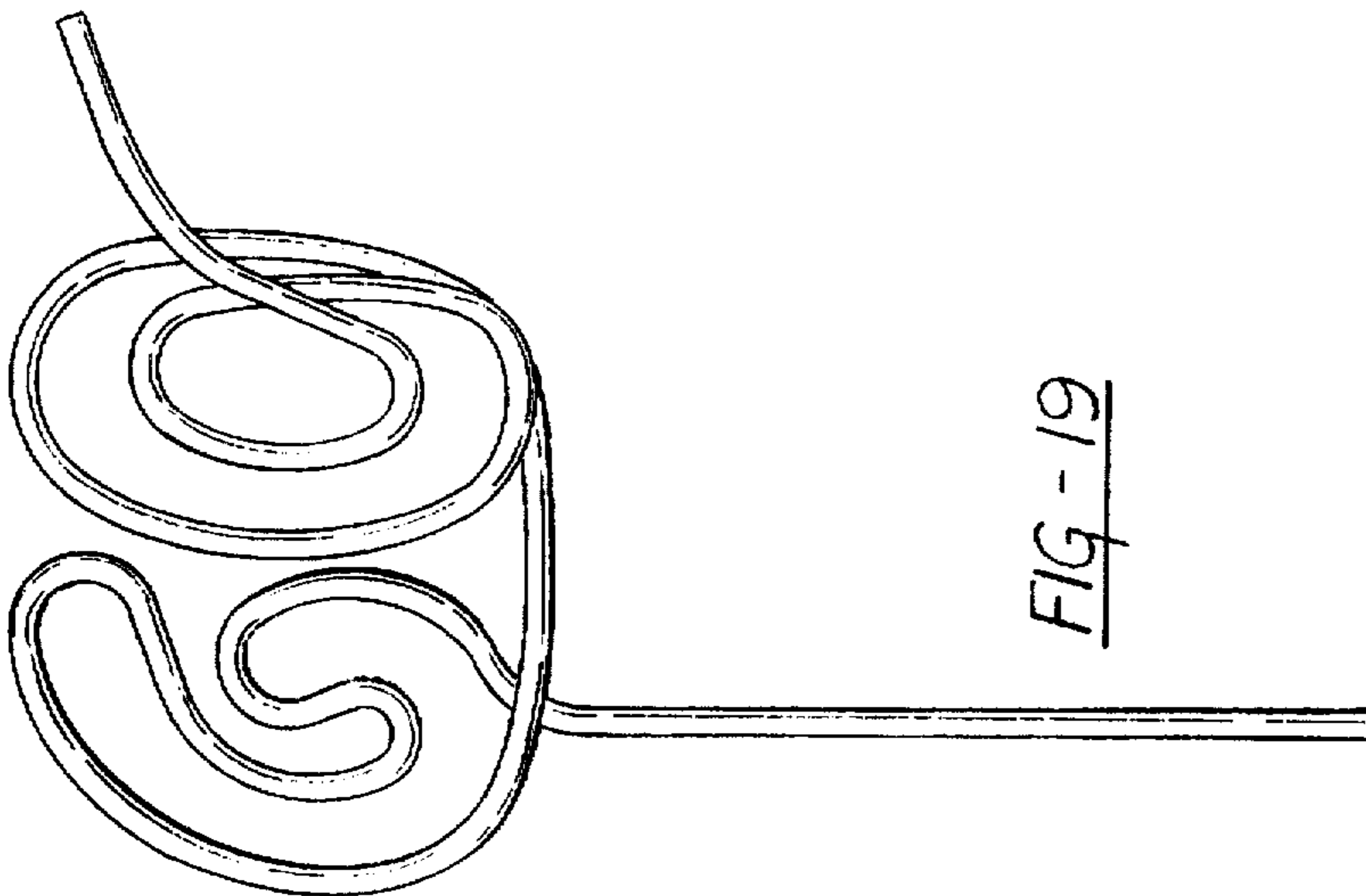

FIG-19

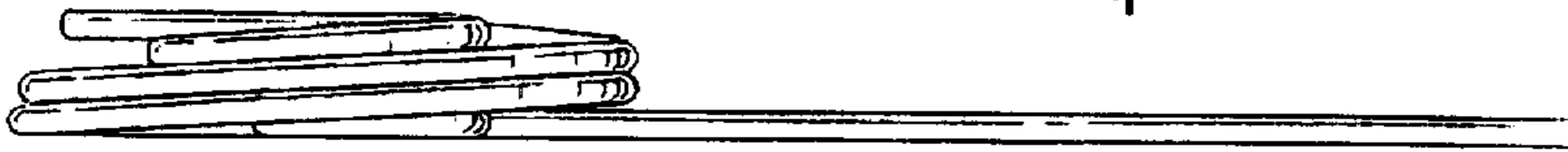

FIG-20

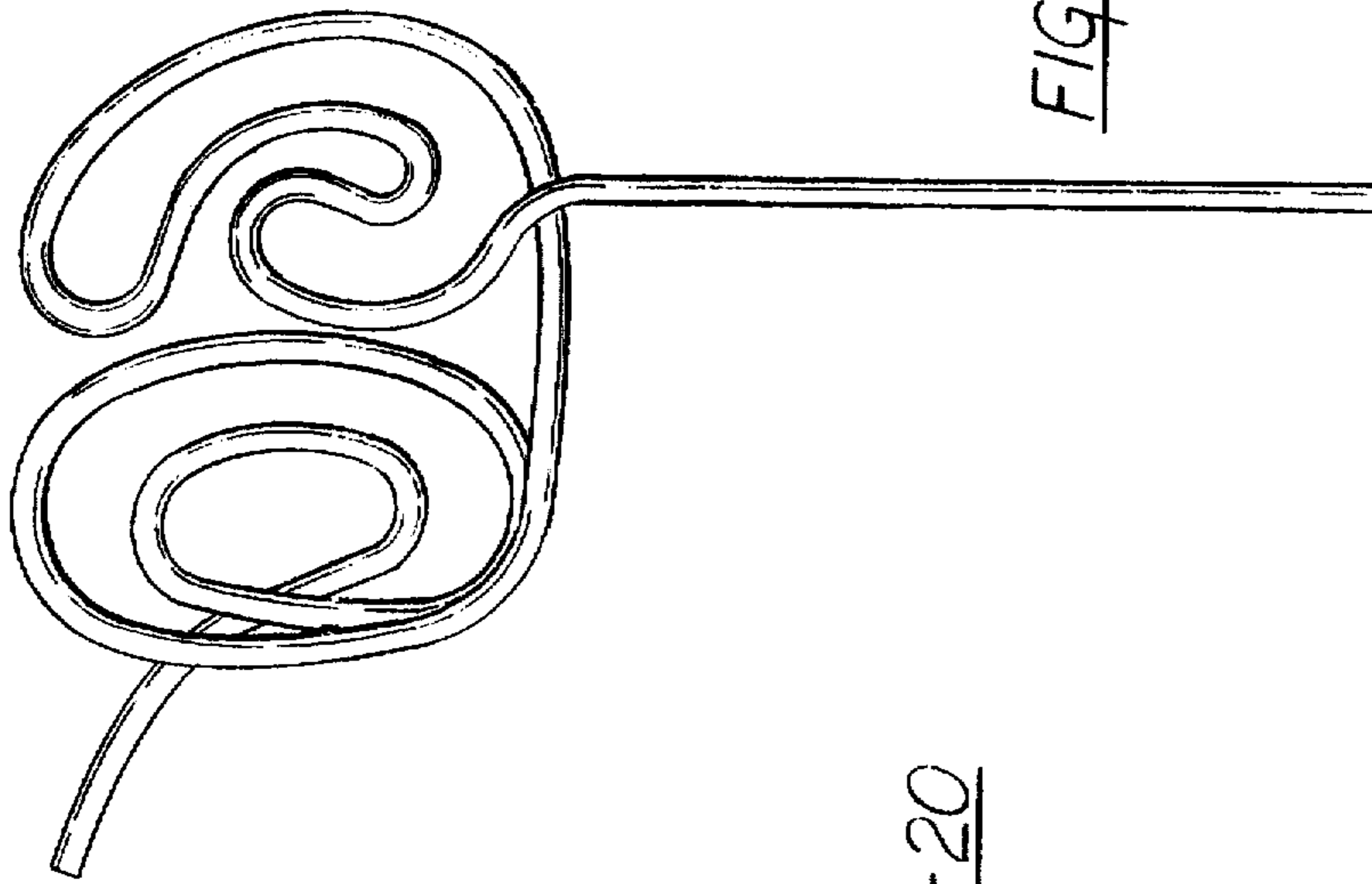

FIG-21

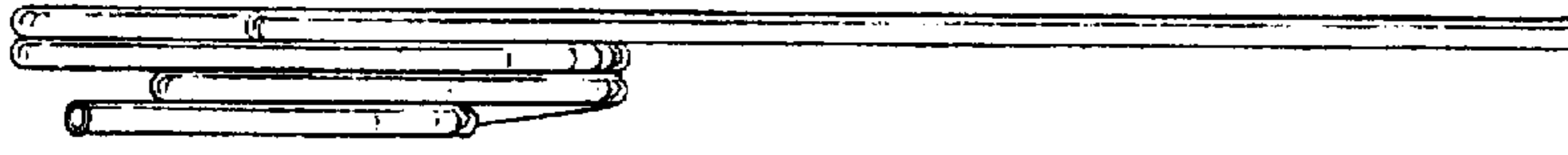

FIG-22

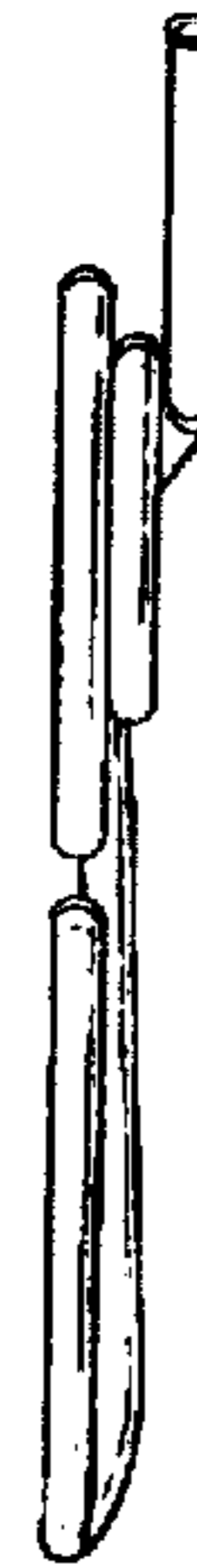

FIG-23



FIG-24

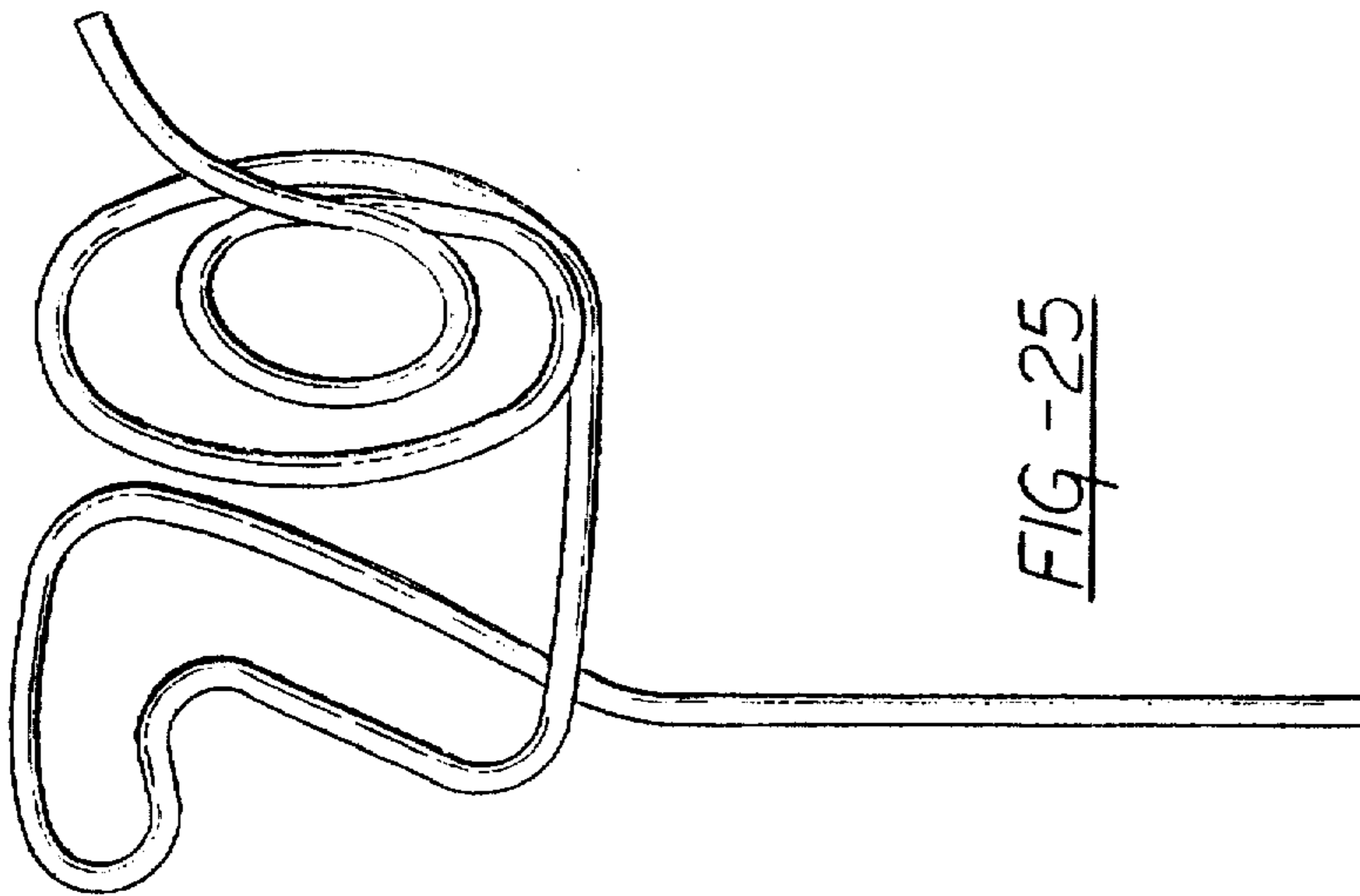

FIG-25

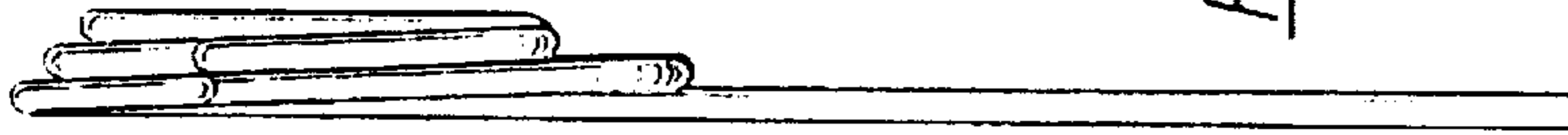

FIG-26

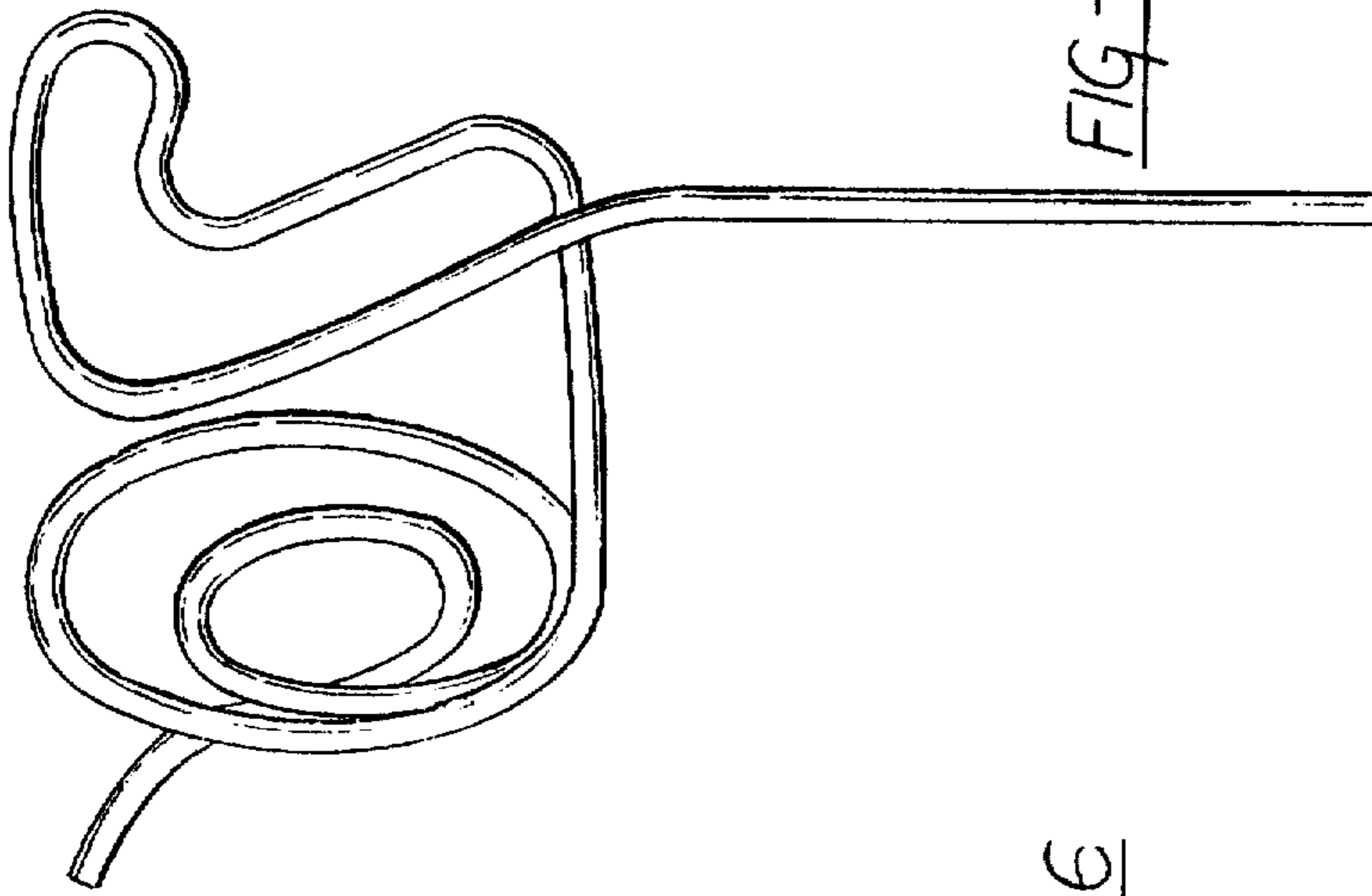

FIG-27

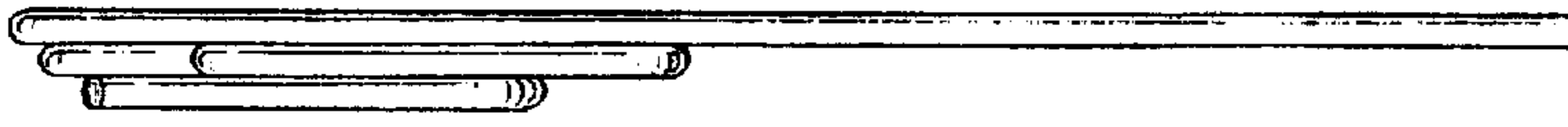

FIG-28

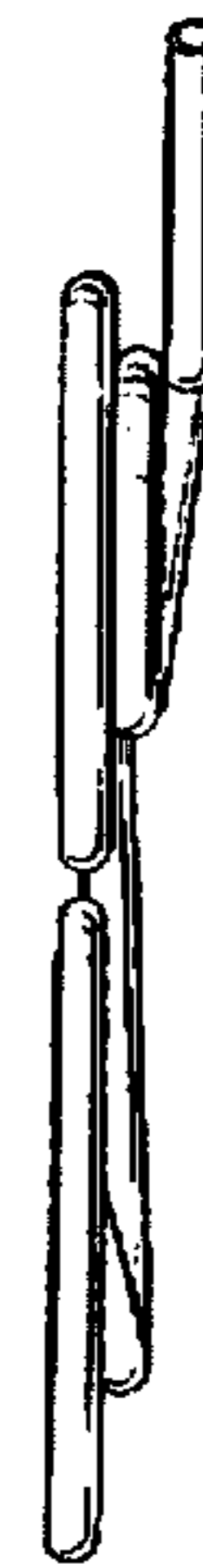

FIG-29



FIG-30