



US00D389307S

United States Patent [19]
Zimmerman

[11] **Patent Number: Des. 389,307**
[45] **Date of Patent: **Jan. 20, 1998**

[54] **STACKABLE TWO-PIECE CONTAINER FOR A CYLINDER HEAD**

[76] **Inventor: Wade Zimmerman, P.O. Box 3504, Thousand Oaks, Calif. 91359**

[**] **Term: 14 Years**

[21] **Appl. No.: 52,592**

[22] **Filed: Apr. 4, 1996**

[51] **LOC (6) Cl. 03-01**

[52] **U.S. Cl. D3/273; D9/425**

[58] **Field of Search D3/269, 273; D9/420, D9/423, 424, 425; 206/319, 223, 509, 511, 515, 519, 505**

[56] **References Cited**

U.S. PATENT DOCUMENTS

D. 285,413	9/1986	Carlson	D9/425
D. 285,906	9/1986	Tyler	D9/425
D. 308,340	6/1990	Ilse et al.	D9/425
D. 320,742	10/1991	Phan	D9/425
D. 330,161	10/1992	Schuh	D9/425
D. 343,795	2/1994	Verchere	D9/425
D. 351,765	10/1994	Beeler et al.	D9/424
D. 356,256	3/1995	Romanoff	D9/425
D. 363,663	10/1995	Plater	D9/425
4,174,036	11/1979	Beckman et al.	206/319
4,373,642	2/1983	Wolters et al.	206/509

Primary Examiner—Philip S. Hyder

Attorney, Agent, or Firm—Richard Slehofer

[57] **CLAIM**

The ornamental design for a stackable two-piece container for a cylinder head, as shown and described.

DESCRIPTION

FIG. 1 is a perspective view of the front of a stackable two-piece container for a cylinder head showing my new design;

FIG. 2 is a bottom perspective view thereof;

FIG. 3 is a top plan view thereof;

FIG. 4 is a bottom plan view thereof;

FIG. 5 is a front elevational view thereof;

FIG. 6 is a right side elevational view thereof;

FIG. 7 is a left side elevational view thereof;

FIG. 8 is a rear elevational view thereof;

FIG. 9 is a front perspective view thereof, wherein the broken line showing of the two additional containers is for illustrative purposes only and forms no part of the claimed design;

FIG. 10 is a partial cut away perspective view thereof; wherein the broken line showing of a cylinder head is for illustrative purposes only and forms no part of the claimed design; and,

FIG. 11 is a longitudinal cross section view taken along line 11—11 of FIG. 3, wherein the broken line showing of a cylinder head is for illustrative purposes only and forms no part of the claimed design.

1 Claim, 5 Drawing Sheets

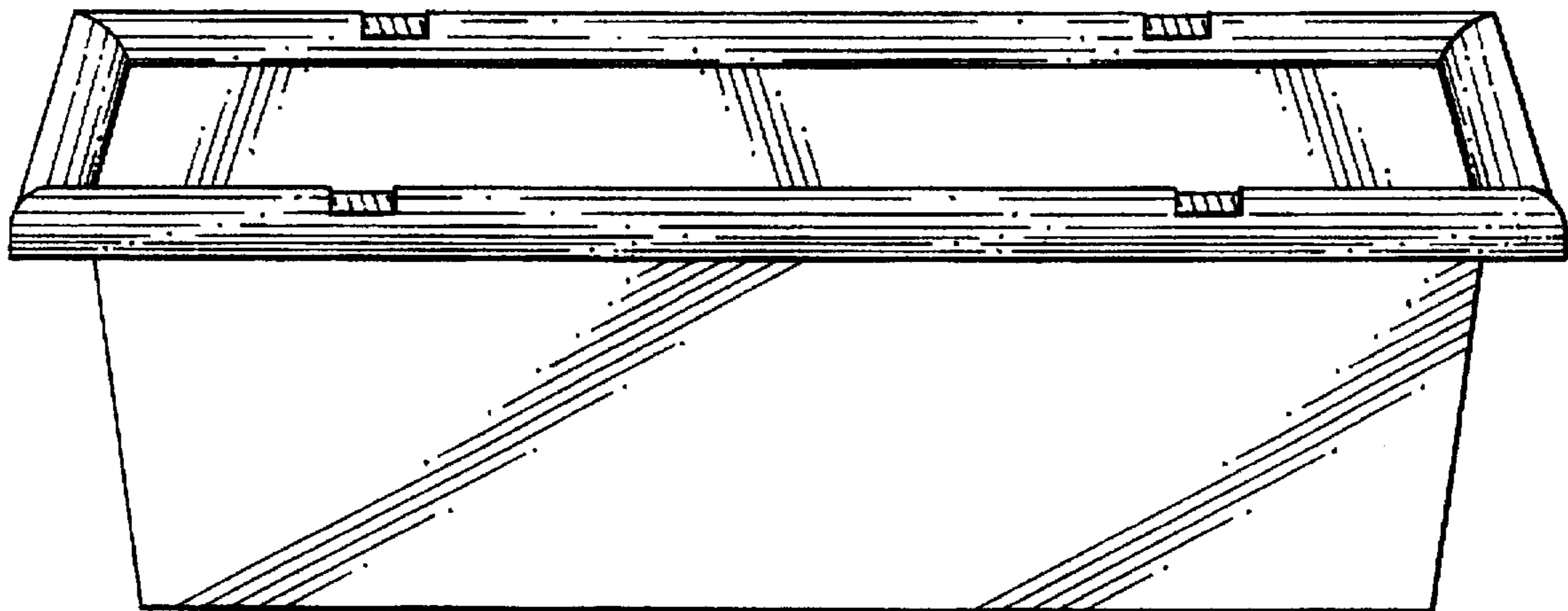

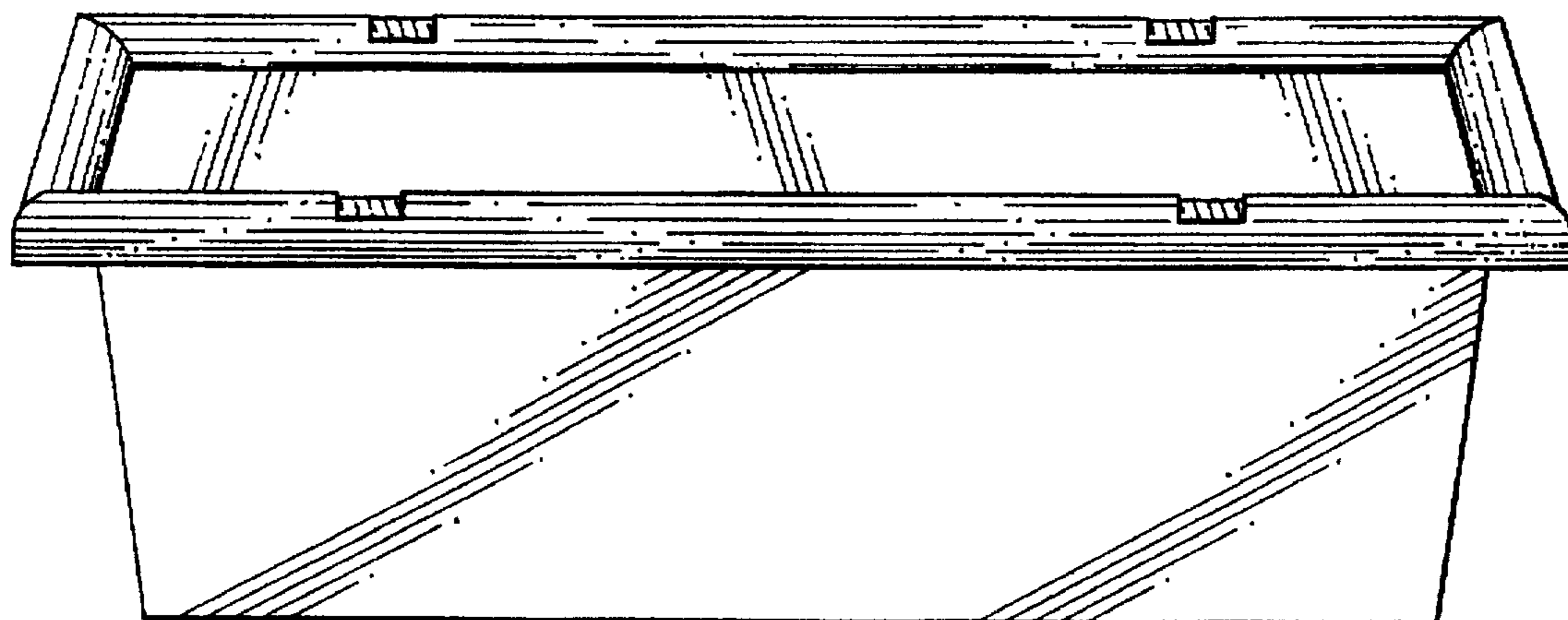

FIG. 1

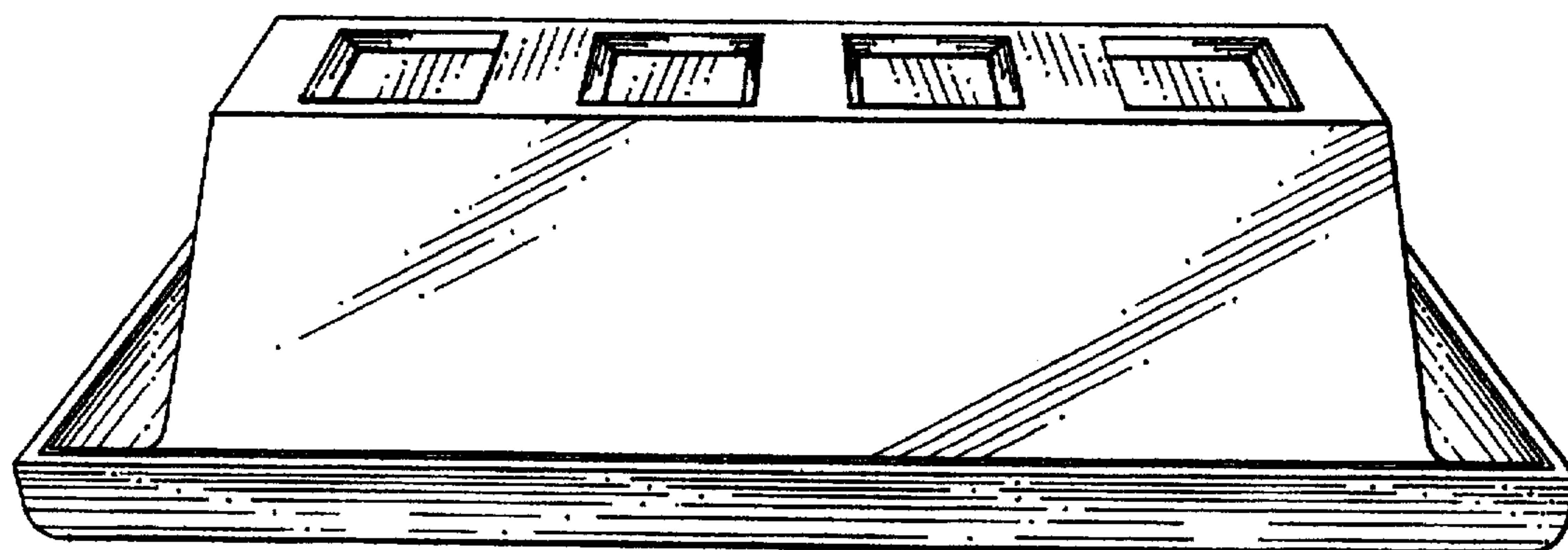

FIG. 2

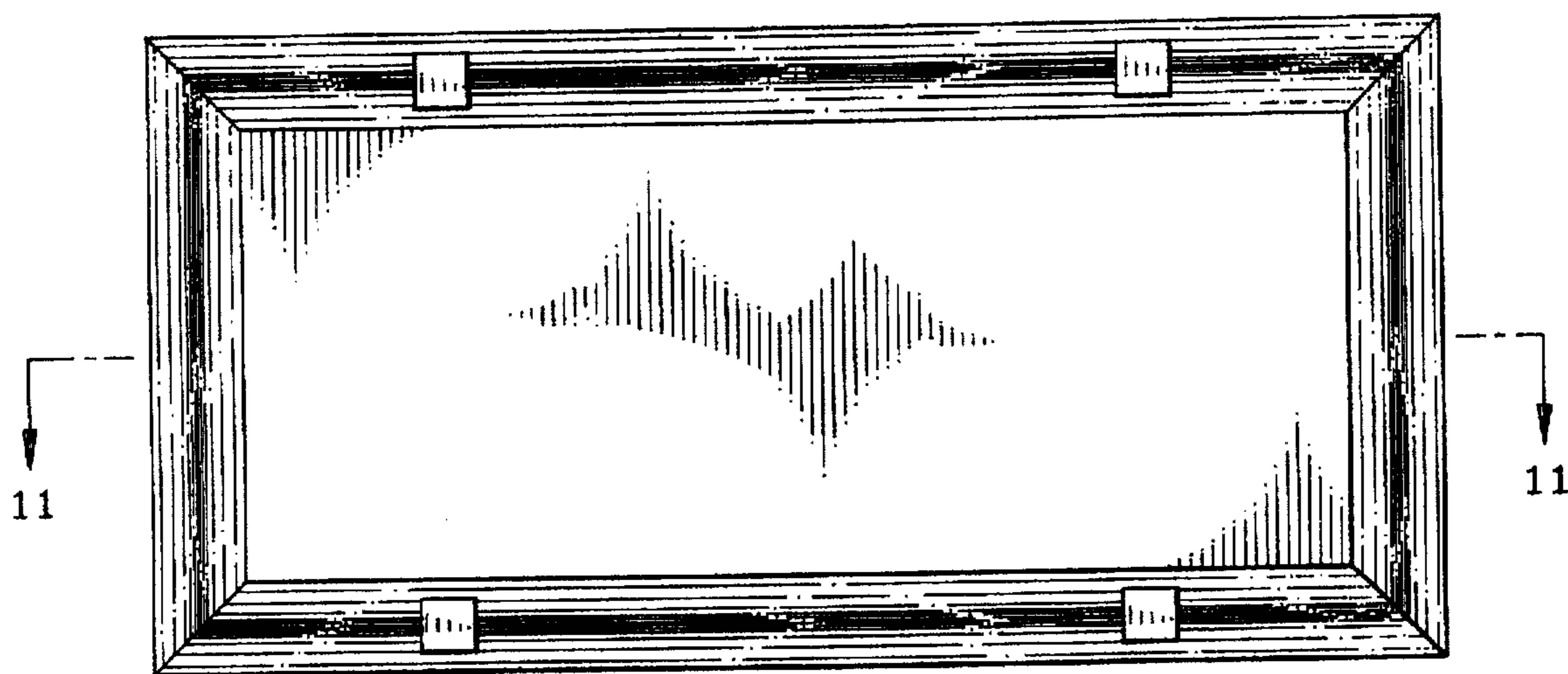

FIG. 3

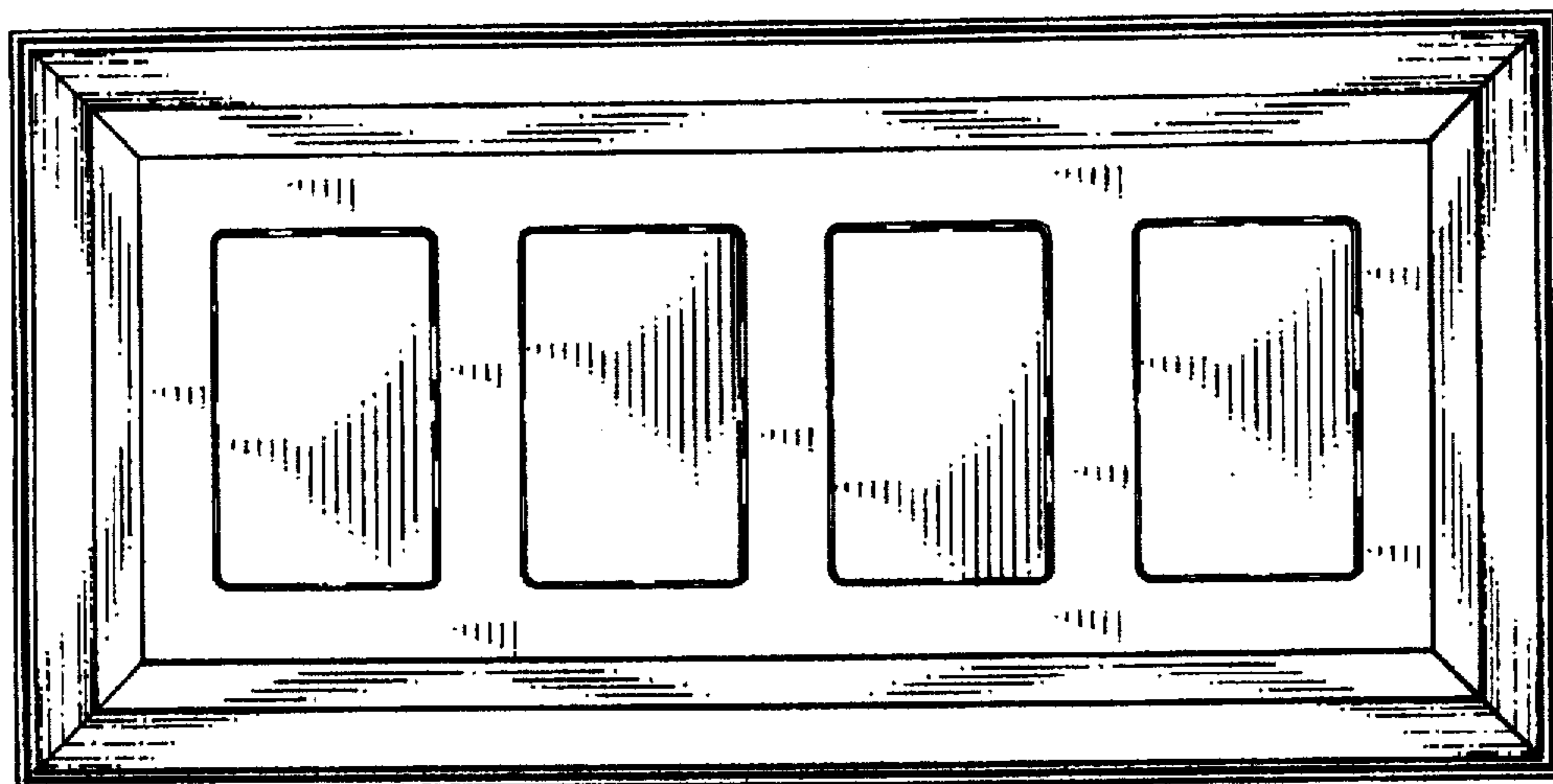

FIG. 4

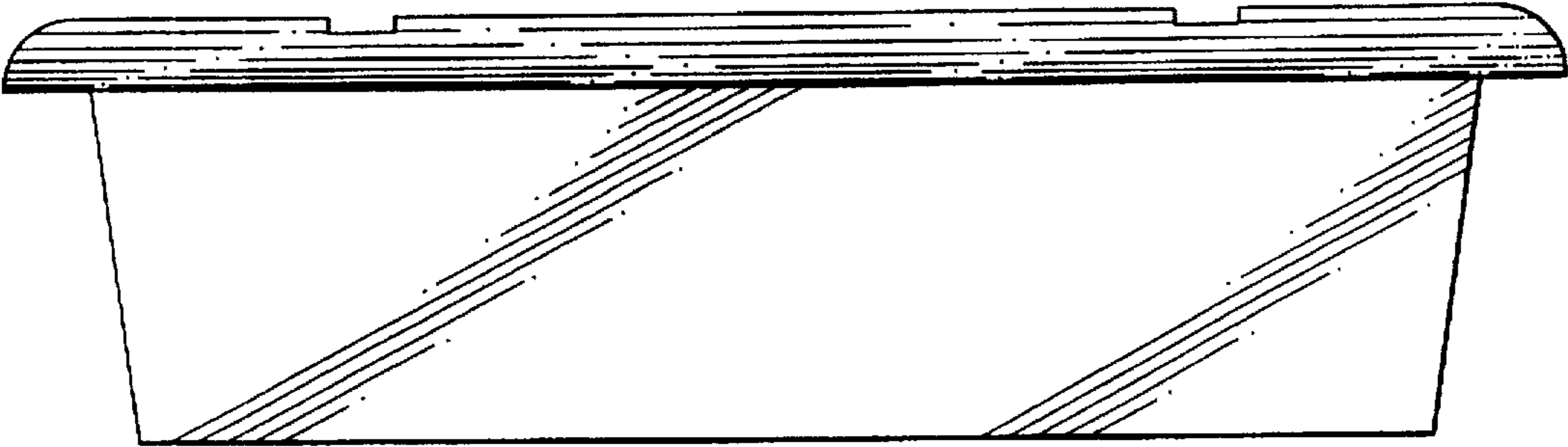

FIG. 5

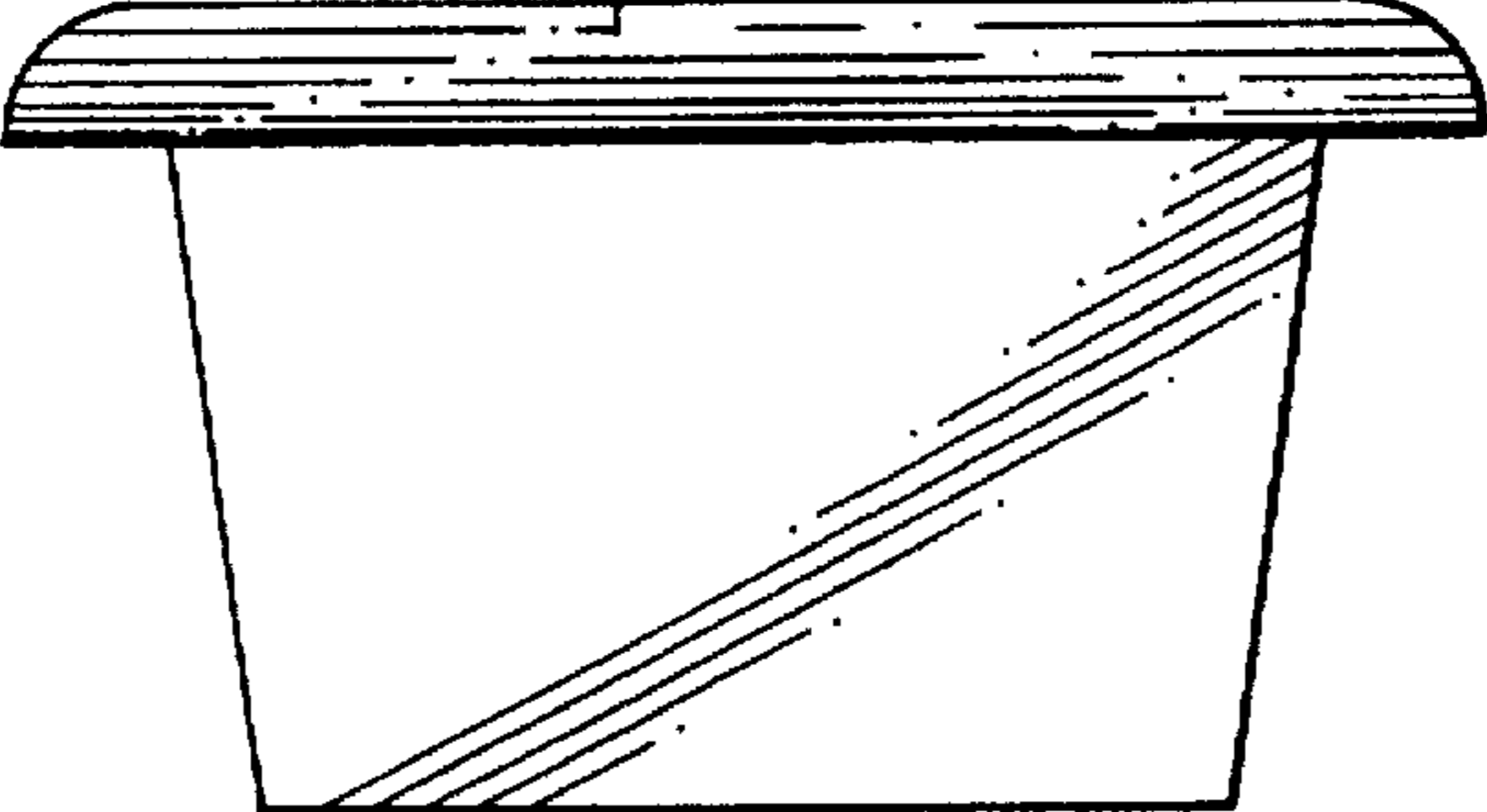

FIG. 6

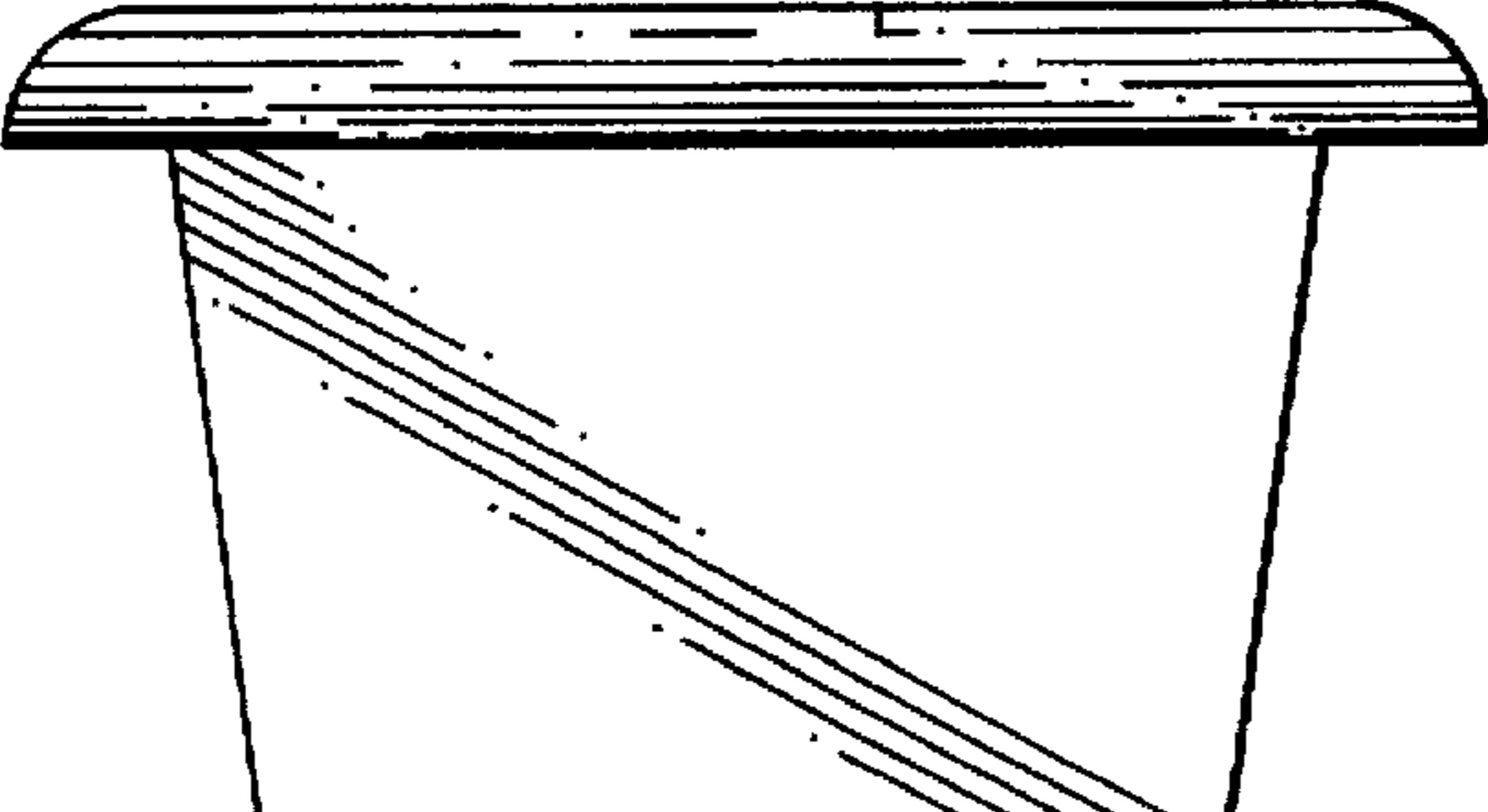

FIG. 7

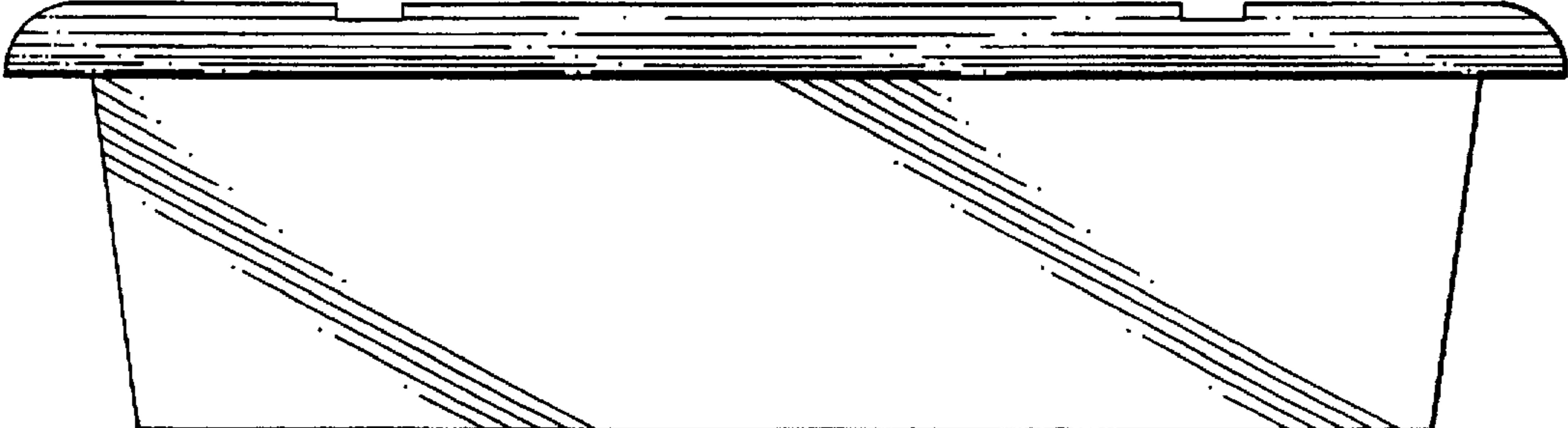

FIG. 8

FIG. 9

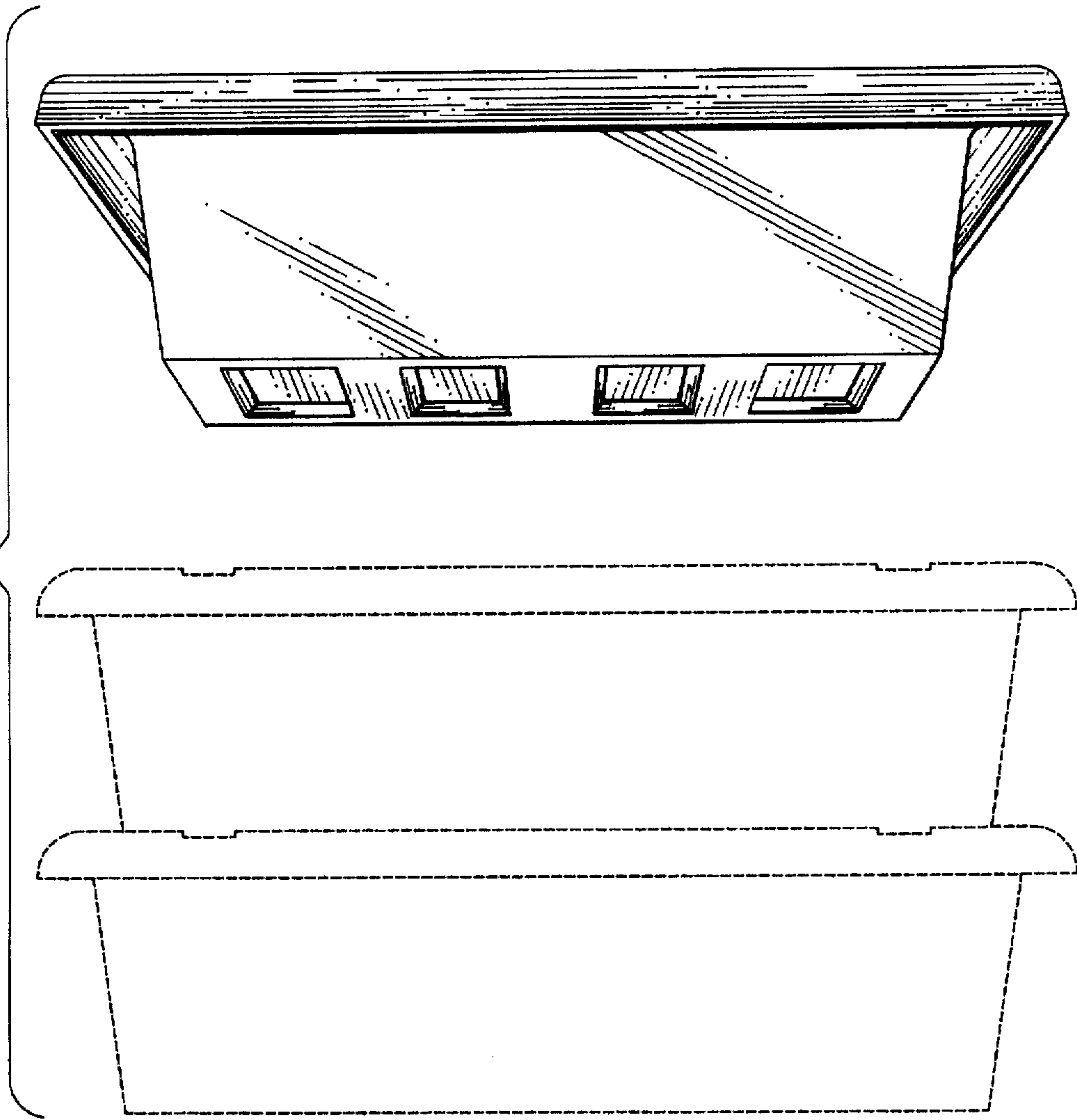
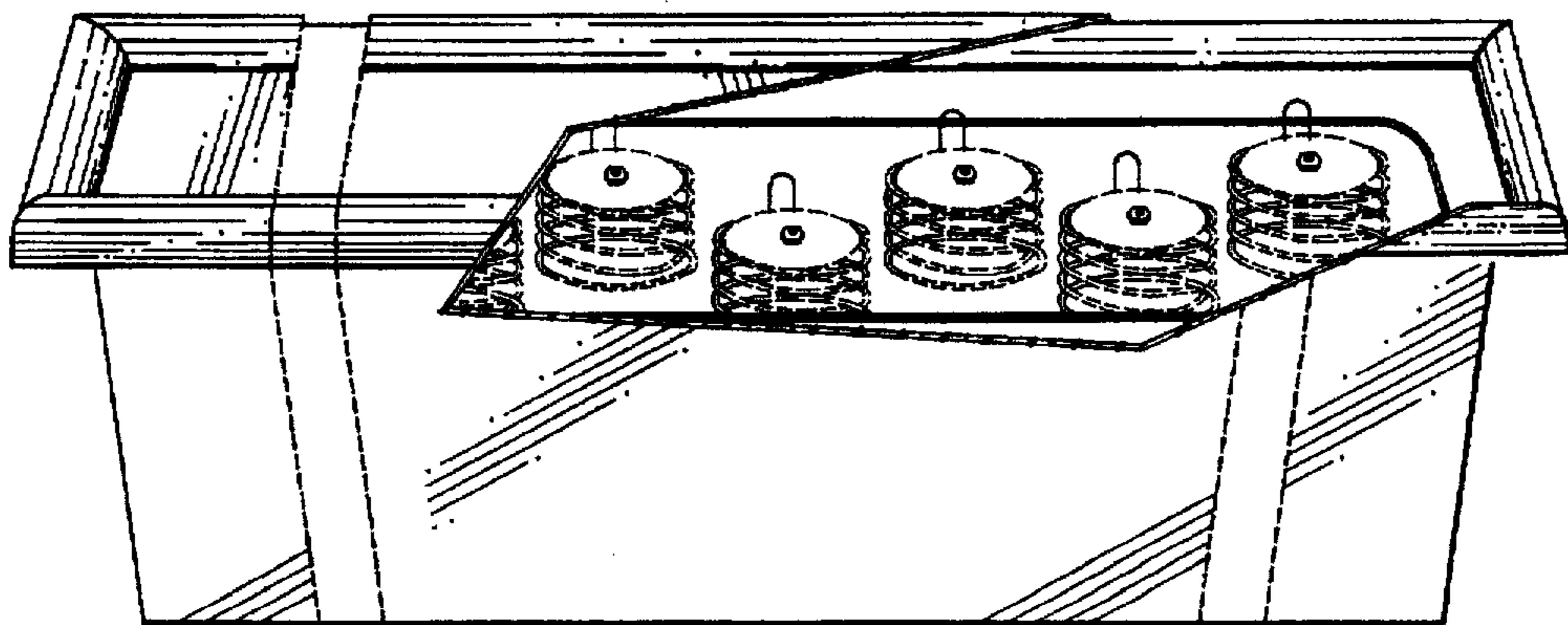

FIG. 10



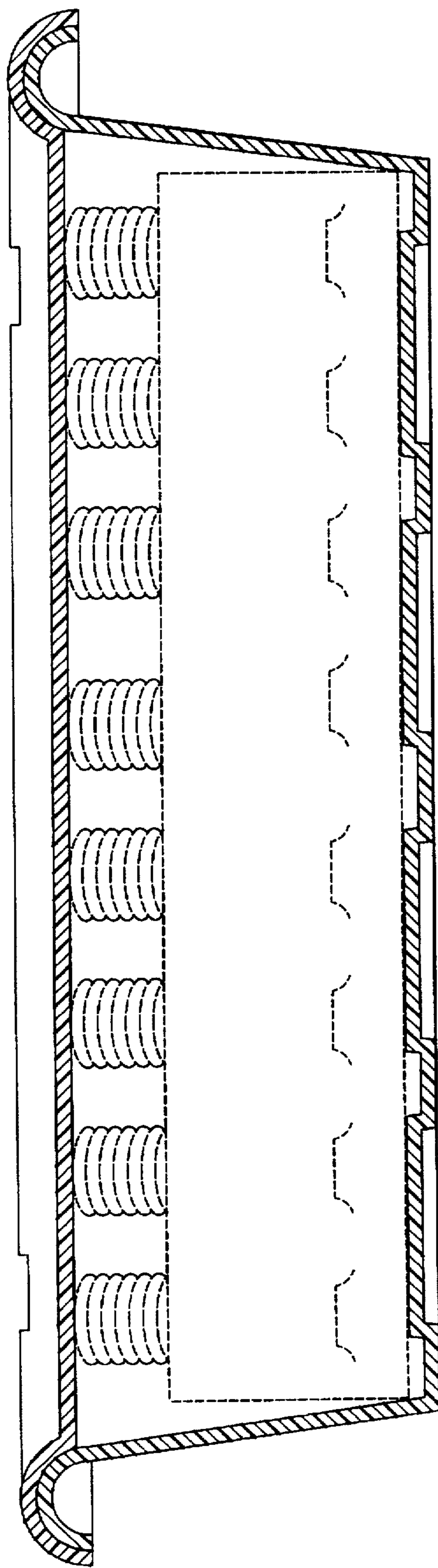

FIG. 11