

US00D389272S

United States Patent [19]

Ryu

[11] Patent Number: **Des. 389,272**

[45] Date of Patent: ****Jan. 13, 1998**

[54] **DISPOSABLE RAZOR**

[75] Inventor: **Ki-Jae Ryu**, Seoul, Rep. of Korea

[73] Assignee: **Dorco Co., Ltd.**, Kyungki-do, Rep. of Korea

[**] Term: **14 Years**

[21] Appl. No.: **32,811**

[22] Filed: **Dec. 29, 1994**

[30] **Foreign Application Priority Data**

Oct. 21, 1994 [KR] Rep. of Korea 29933/1994

[51] LOC (6) Cl. **28-03**

[52] U.S. Cl. **D28/46**

[58] Field of Search D28/44-48; 30/32, 30/48-50, 85

[56] **References Cited**

U.S. PATENT DOCUMENTS

H418 2/1988 Lee D28/46
D. 241,583 9/1976 Asano D28/46

D. 250,130 10/1978 Douglas D28/46
D. 260,303 8/1981 Wordtmann D28/46
D. 268,291 3/1983 Jones D28/48
D. 269,915 7/1983 Iten et al. D28/46
4,587,730 5/1986 Iten 30/32 X
4,754,547 7/1988 Butka 30/32 X

Primary Examiner—Sandra L. Morris
Assistant Examiner—C. Tuttle
Attorney, Agent, or Firm—Ratner & Prestia

[57] **CLAIM**

The ornamental design for a disposable razor, as shown and described.

DESCRIPTION

FIG. 1 is a perspective view of a disposable razor showing my new design;
FIG. 2 is a top plan view thereof;
FIG. 3 is a front elevation view thereof;
FIG. 4 is a right side elevation view thereof;
FIG. 5 is a left side elevation view thereof;
FIG. 6 is a back elevation view thereof; and
FIG. 7 is a bottom plan view thereof.

1 Claim, 3 Drawing Sheets

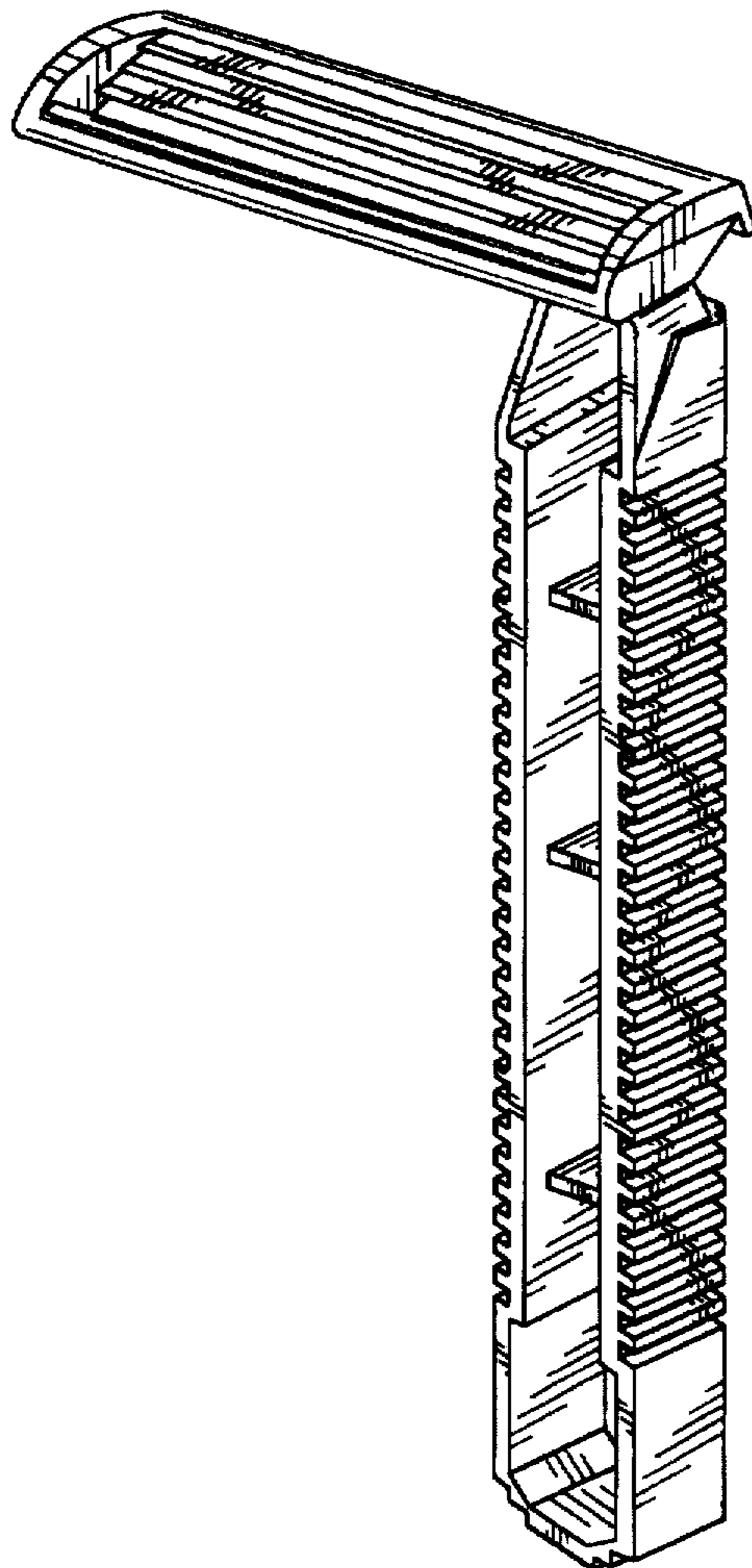

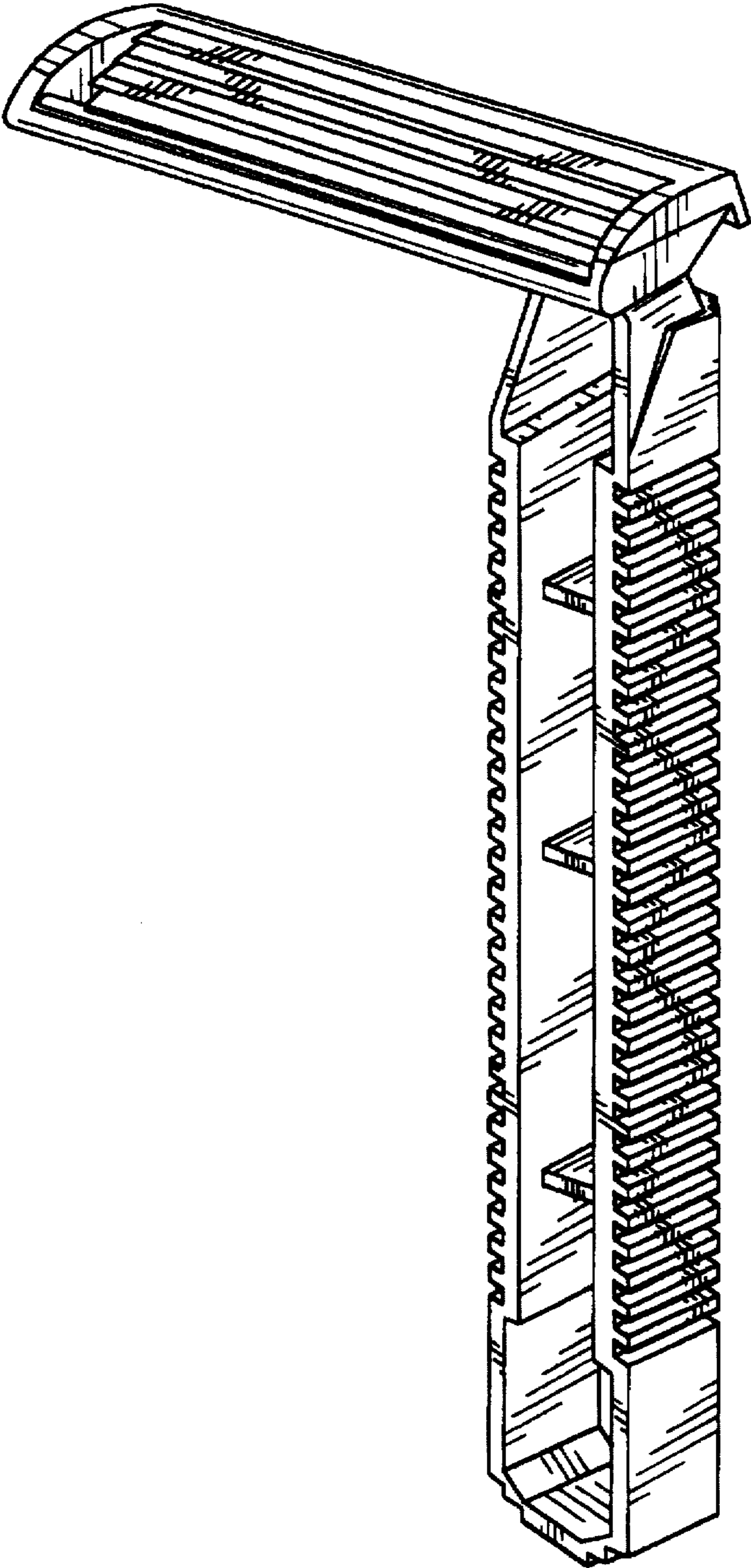

FIG. 1

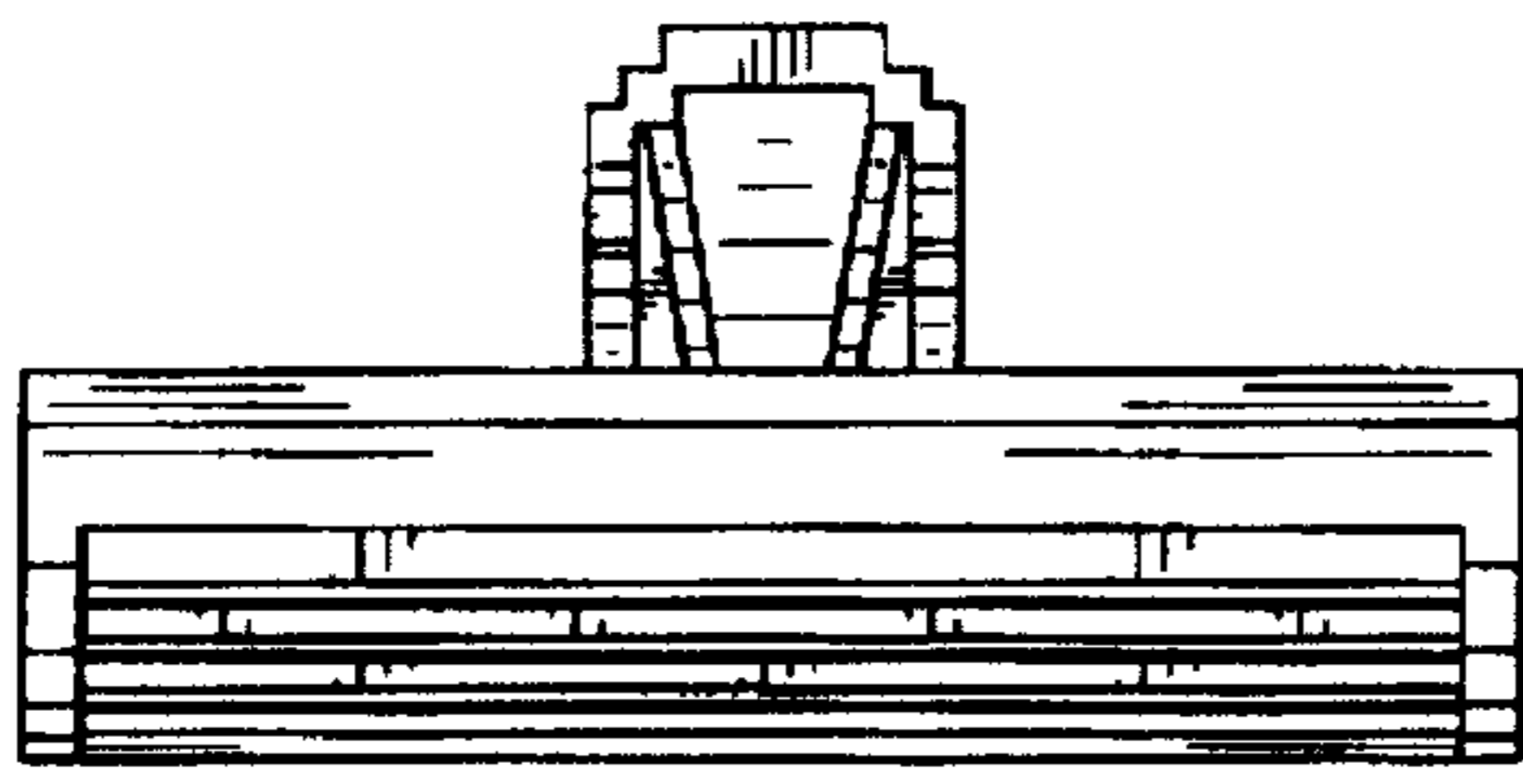

FIG. 2

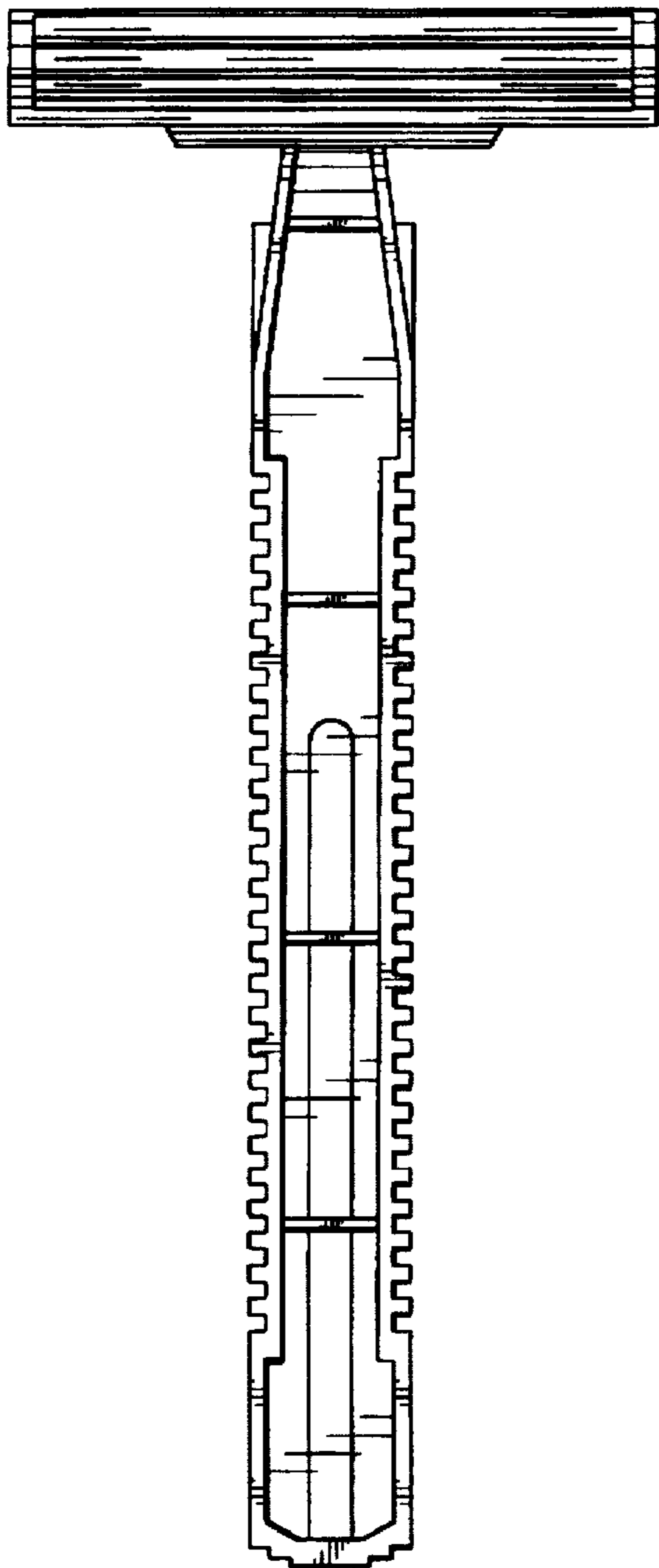

FIG. 3

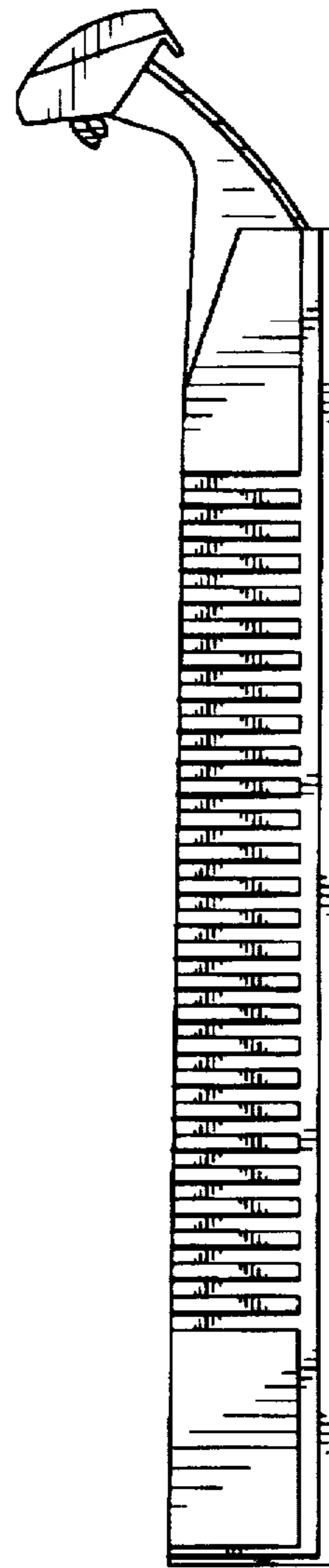

FIG. 4

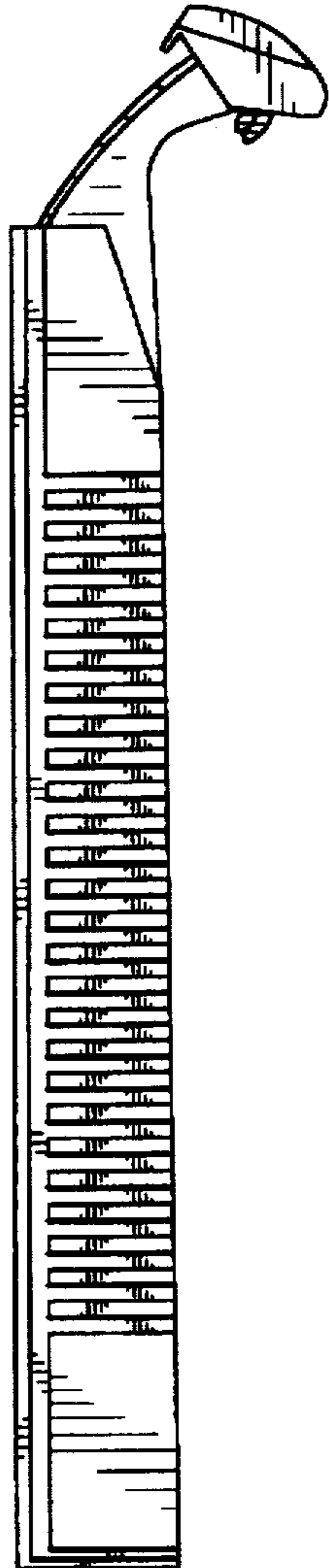

FIG. 5

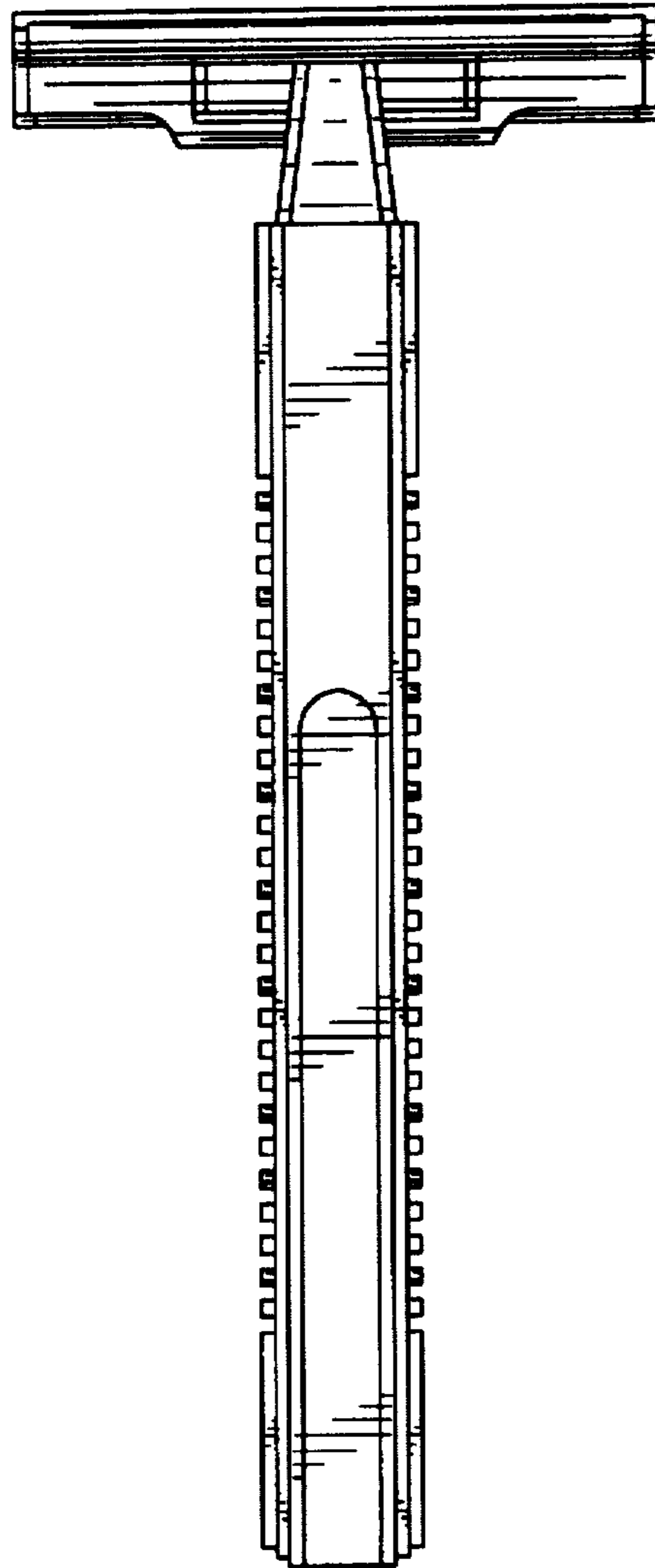

FIG. 6

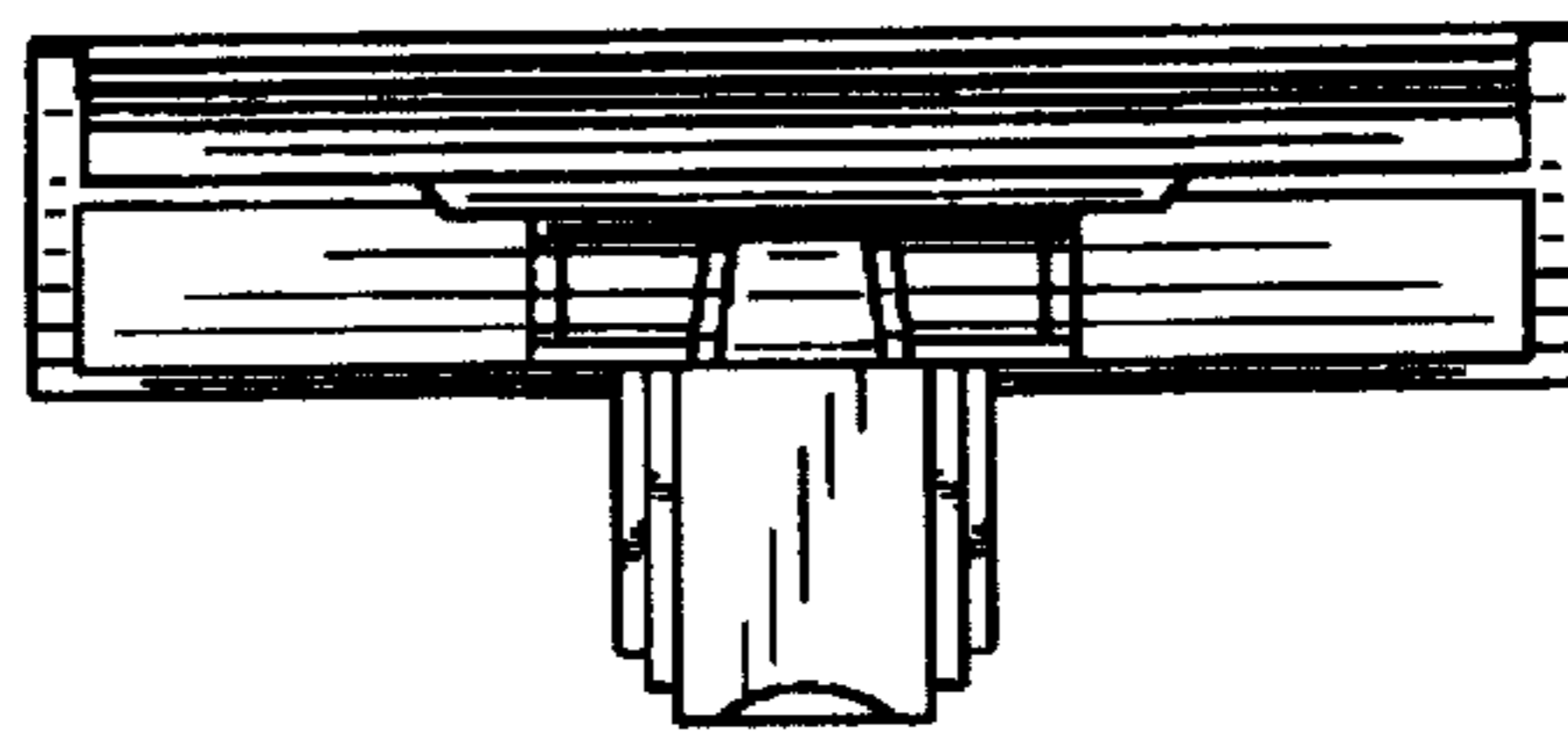

FIG. 7