



US00D389262S

# United States Patent [19] Compton

[11] Patent Number: **Des. 389,262**

[45] Date of Patent: **\*\*Jan. 13, 1998**

[54] **LUMINAIRE**

D. 360,047 7/1995 Zimmerman et al. .... D26/87 X  
4,319,312 3/1982 de Vos et al. .... 362/431 X

[75] Inventor: **Wayne W. Compton**, Chino Hills, Calif.

*Primary Examiner*—Susan J. Lucas  
*Attorney, Agent, or Firm*—Lyon & Lyon LLP

[73] Assignee: **Kim Lighting, Inc.**, City of Industry, Calif.

[57] **CLAIM**

[\*\*] Term: **14 Years**

The ornamental design for a luminaire, as shown and described.

[21] Appl. No.: **43,756**

### DESCRIPTION

[22] Filed: **Sep. 8, 1995**

FIG. 1 is a front elevational view of a luminaire showing the new design, the rear being a mirror image;

[51] LOC (6) Cl. .... **26-05**

FIG. 2 is a top plan view thereof;

[52] U.S. Cl. .... **D26/67; D26/72**

FIG. 3 is a side elevational view thereof, the opposite side being a mirror image;

[58] Field of Search ..... **D26/72, 80-92, D26/67, 68, 69, 70, 71; 362/147, 431, 432**

FIG. 4 is a bottom plan view thereof; and,

[56] **References Cited**

FIG. 5 is an enlarged, fragmentary perspective view thereof, the luminaire being fragmentarily shown for convenience of illustration.

### U.S. PATENT DOCUMENTS

D. 358,902 5/1995 Webster, III ..... D26/87

**1 Claim, 2 Drawing Sheets**

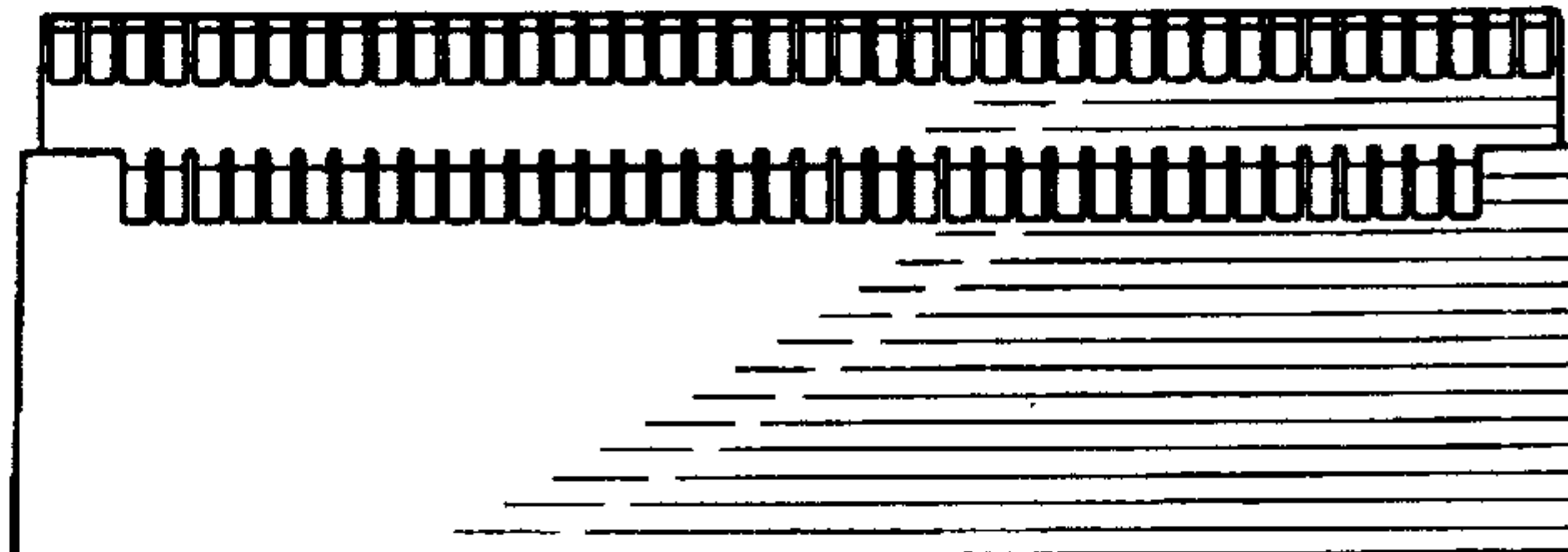
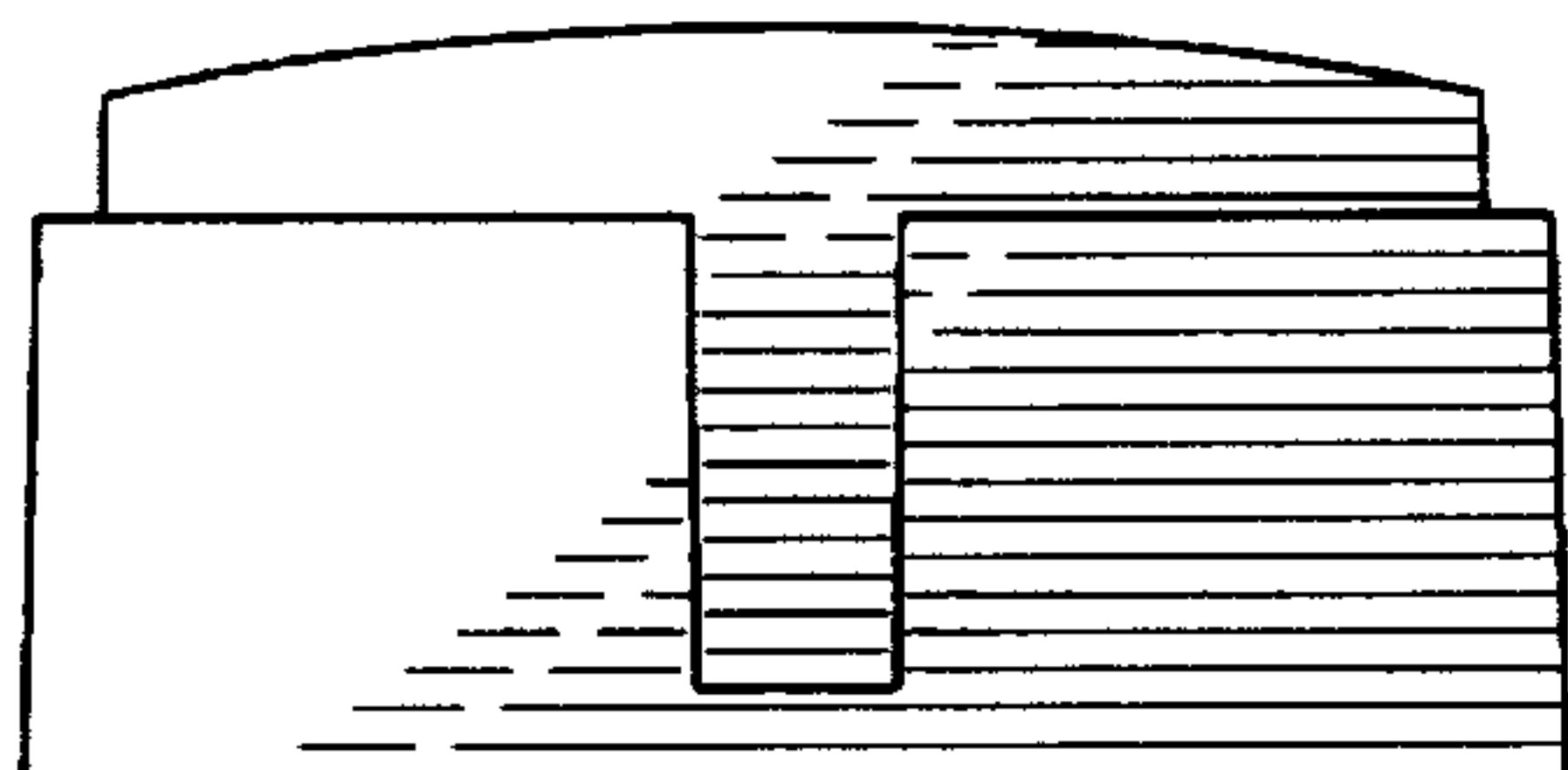
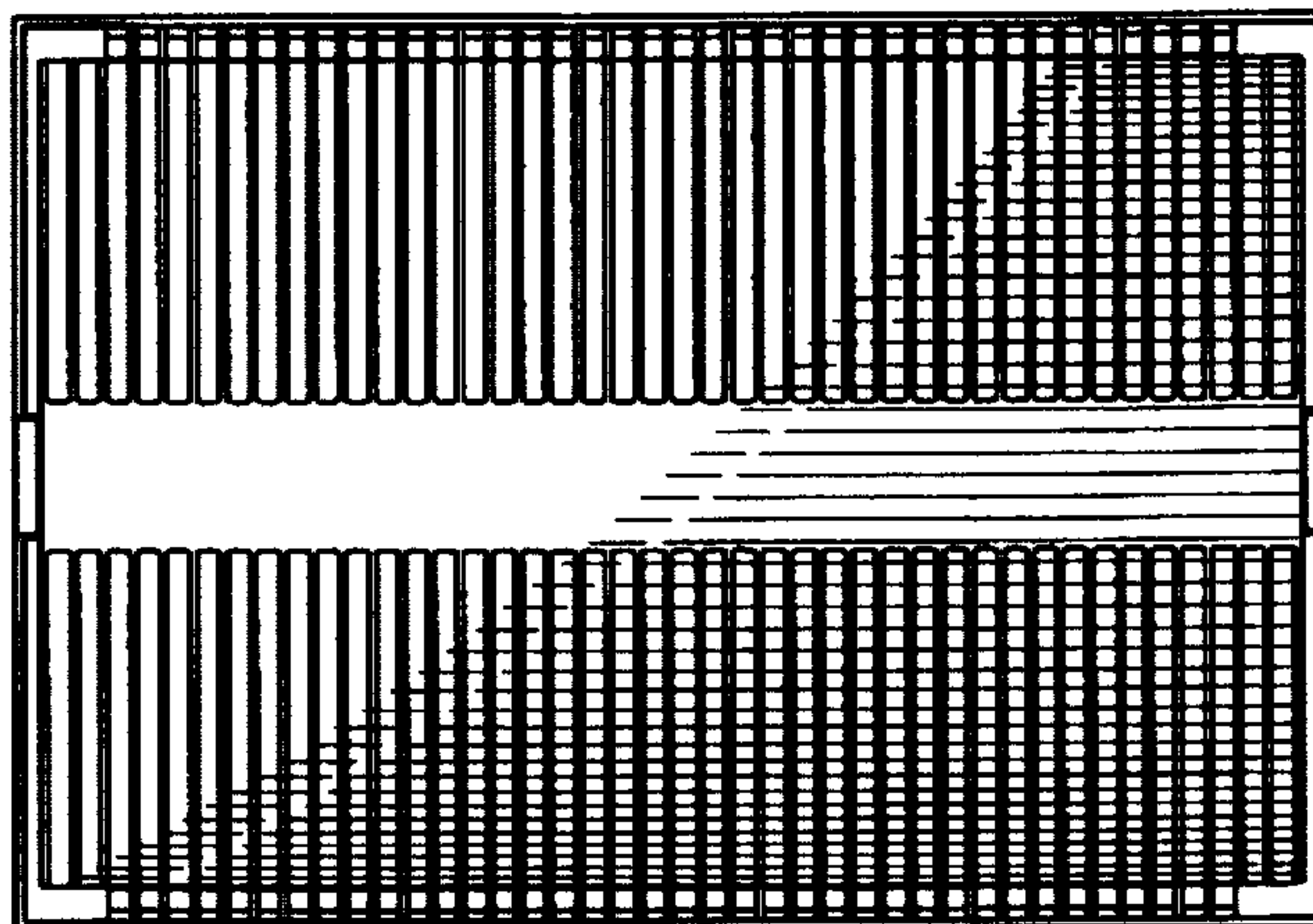

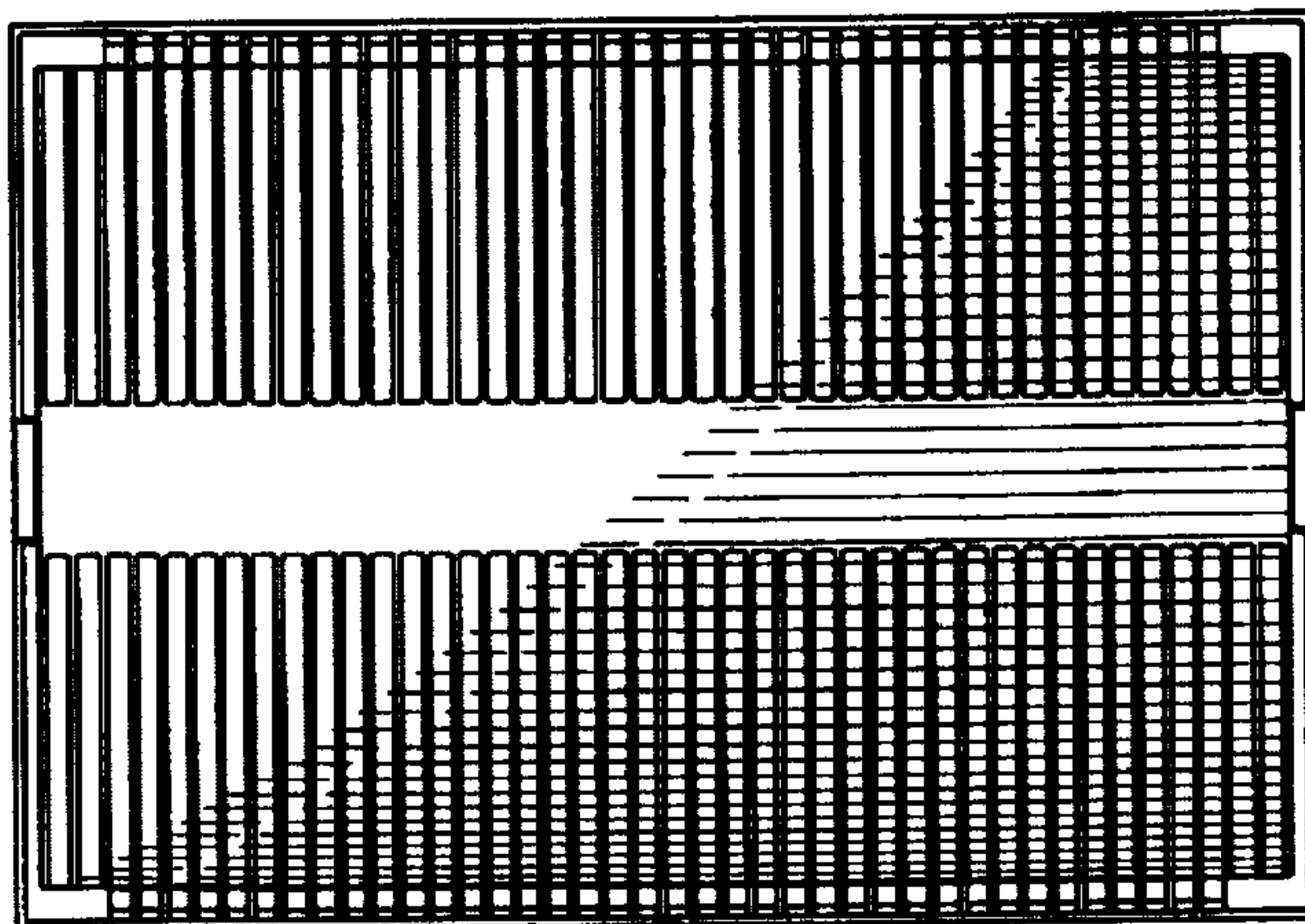

FIG. 2

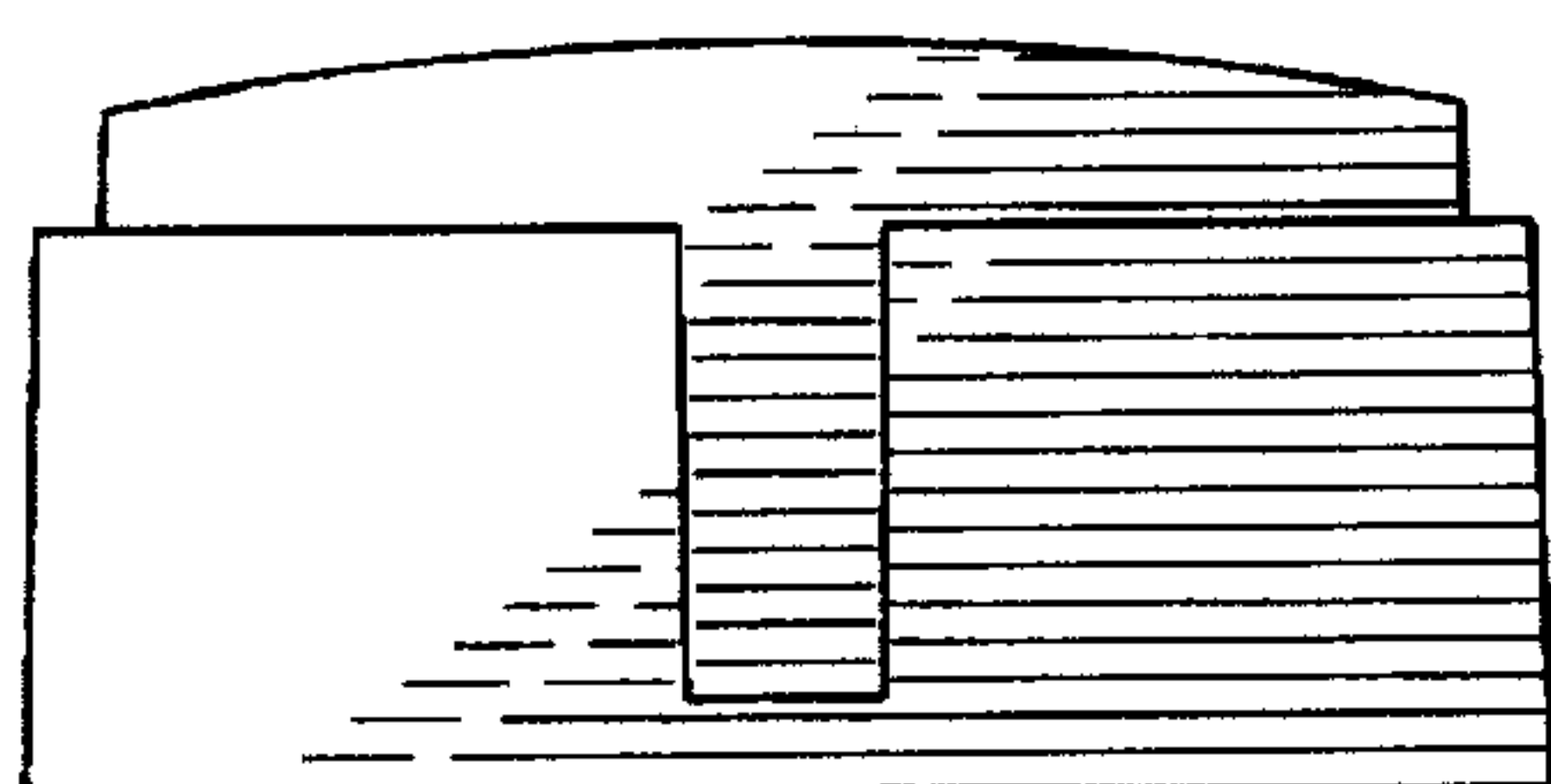

FIG. 1

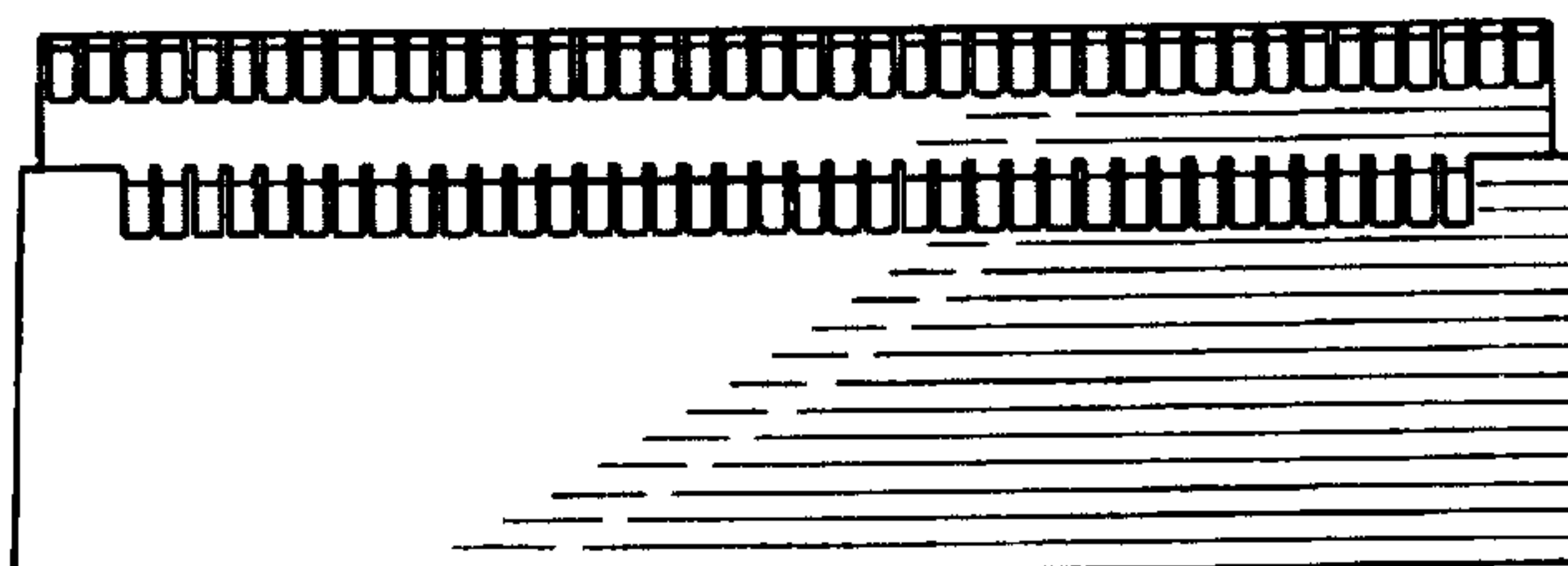

FIG. 3

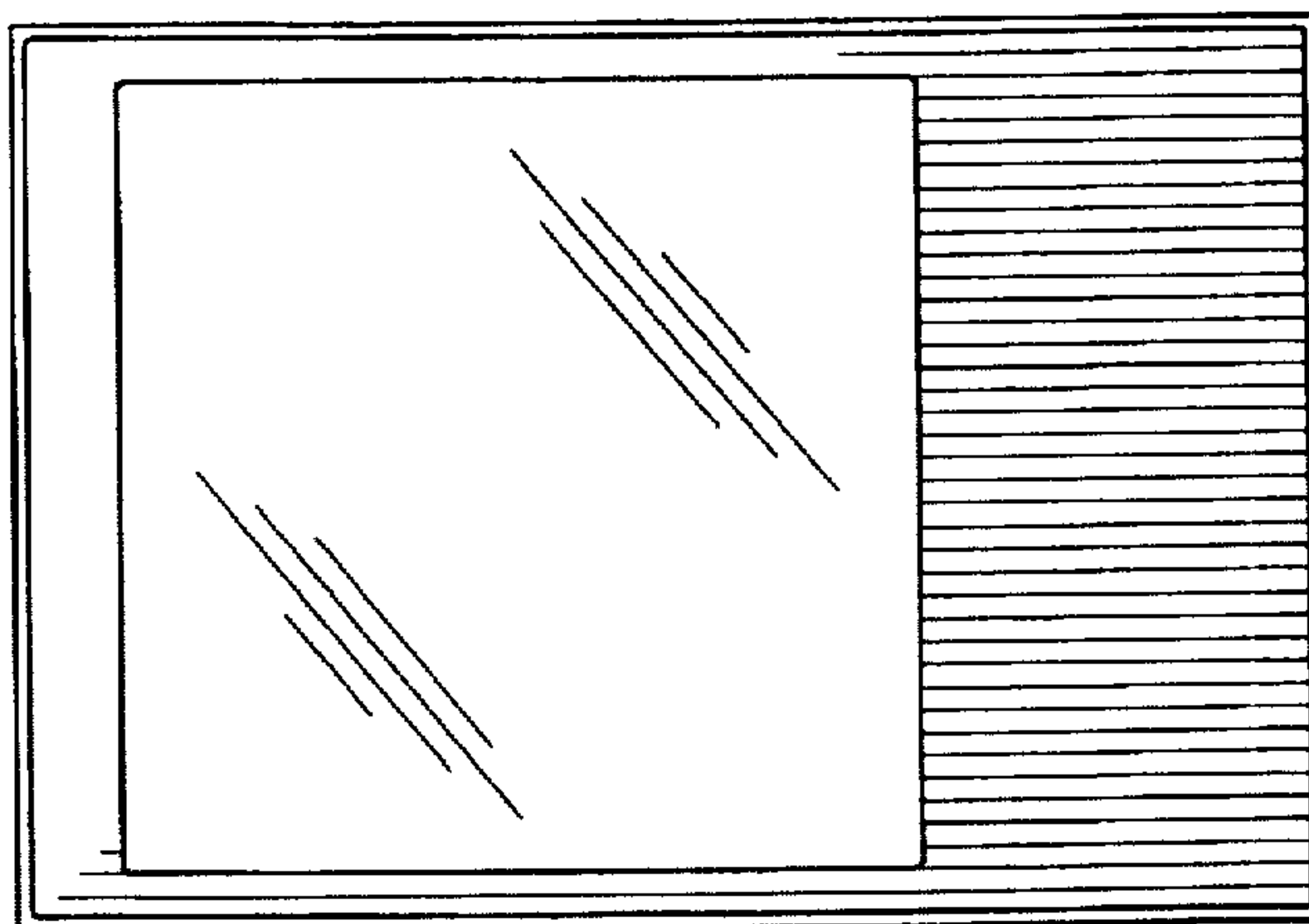

FIG. 4

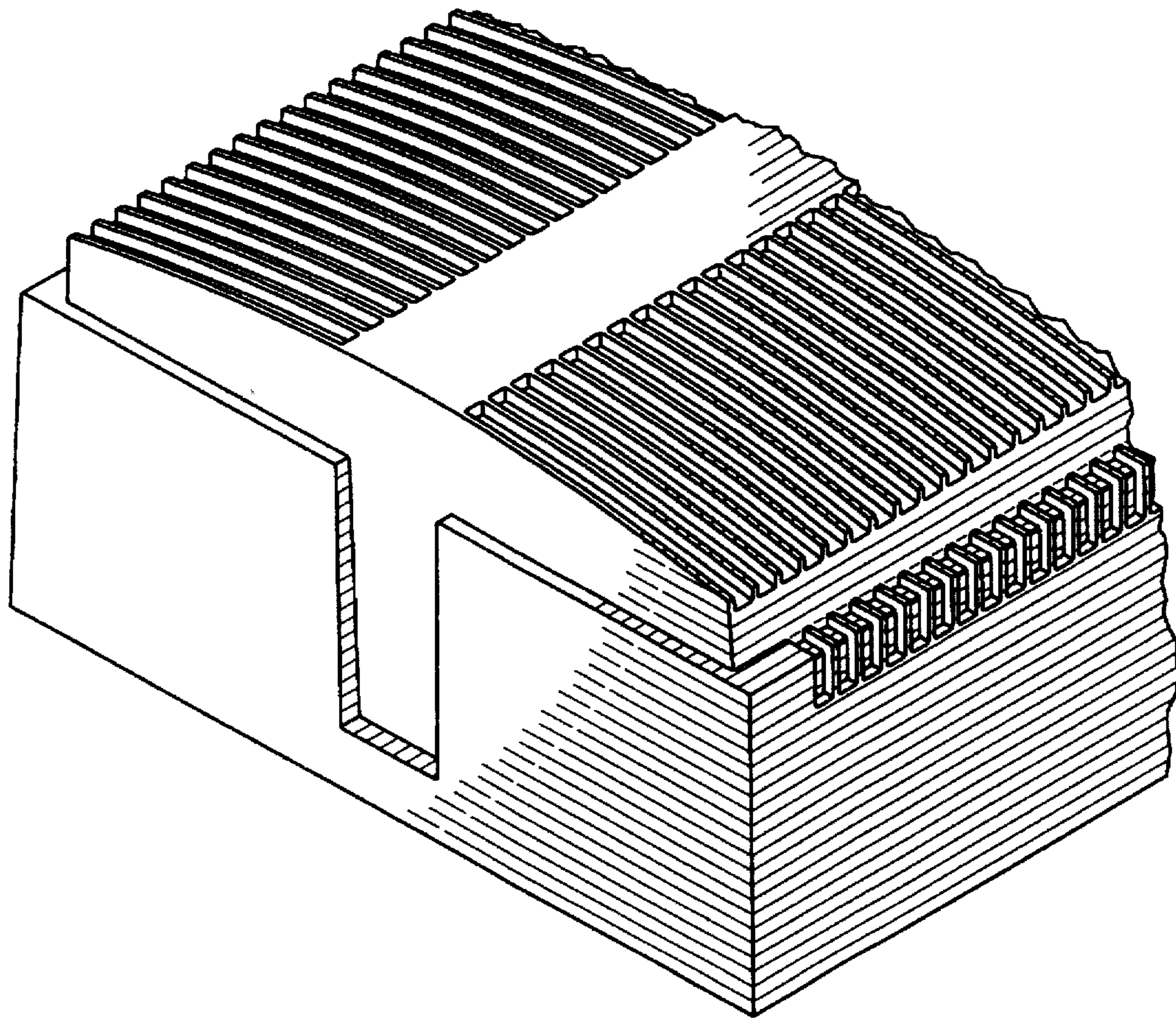

FIG. 5