



US00D389200S

United States Patent [19] Madsen

[11] Patent Number: Des. 389,200

[45] Date of Patent: **Jan. 13, 1998

[54] SANDWICH SHAPED YO-YO

[76] Inventor: Niels Madsen, Dahliahaven 107, Virum, Denmark, 2830

[**] Term: 14 Years

[21] Appl. No.: 52,439

[22] Filed: Mar. 29, 1996

[30] Foreign Application Priority Data

Sep. 29, 1995 [DK] Denmark 0929/1995

[51] LOC (6) Cl. 21-01

[52] U.S. Cl. D21/99; D21/59

[58] Field of Search D21/99, 59; D19/97; 446/247-250, 251

[56] References Cited

U.S. PATENT DOCUMENTS

59,745	11/1866	Haven et al.	446/250
D. 189,583	1/1961	Albert	D21/99
D. 197,239	12/1963	Nelligan	D21/99
D. 232,956	9/1974	Chelman	D21/99
668,829	2/1901	Boehme	446/250
2,676,432	4/1954	Field	446/251
3,953,936	5/1976	Ennis	446/258

Primary Examiner—Dominic Simone
Attorney, Agent, or Firm—Thomas R. Vigil

[57] CLAIM

The ornamental design for a sandwich shaped yo-yo, as shown in the drawings.

DESCRIPTION

FIG. 1 is a perspective view of a sandwich shaped yo-yo showing my new design;

FIG. 2 is an inverted bottom perspective view thereof;

FIG. 3 is an exploded perspective view of a second embodiment of FIG. 1, the difference residing in the smooth surface of the buns with seeds;

FIG. 4 is an exploded top perspective view of a third embodiment of FIG. 1, the difference residing in the smooth surface of the buns without seeds;

FIG. 5 is a top perspective view of a fourth embodiment of FIG. 1, the difference residing in the smooth surface of the top section of the bun and the irregular surface of the bottom section without seeds; and,

FIG. 6 is an exploded perspective view of a fifth embodiment of FIG. 1, the difference residing in the smooth surface of the buns without seeds.

1 Claim, 5 Drawing Sheets

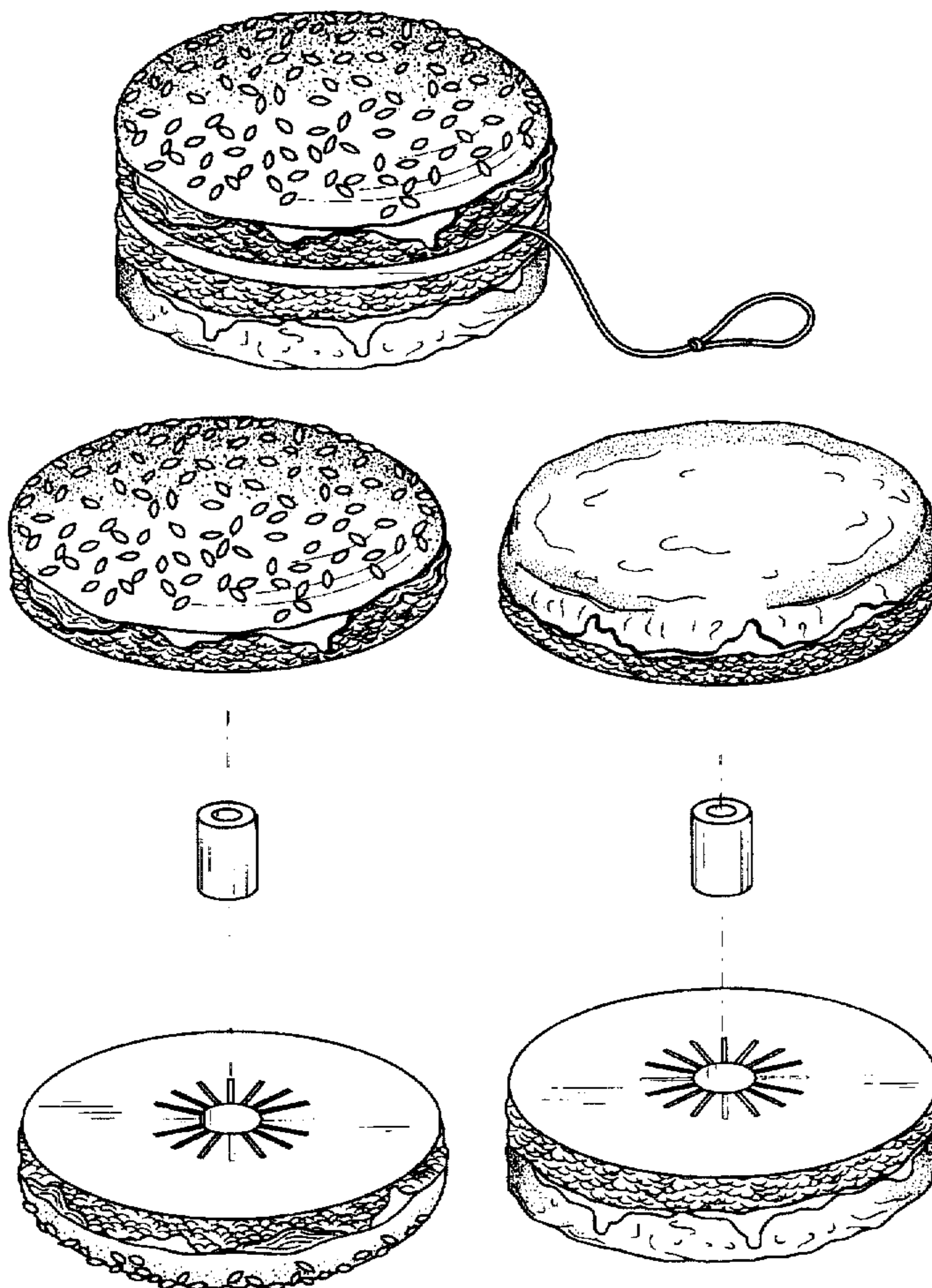

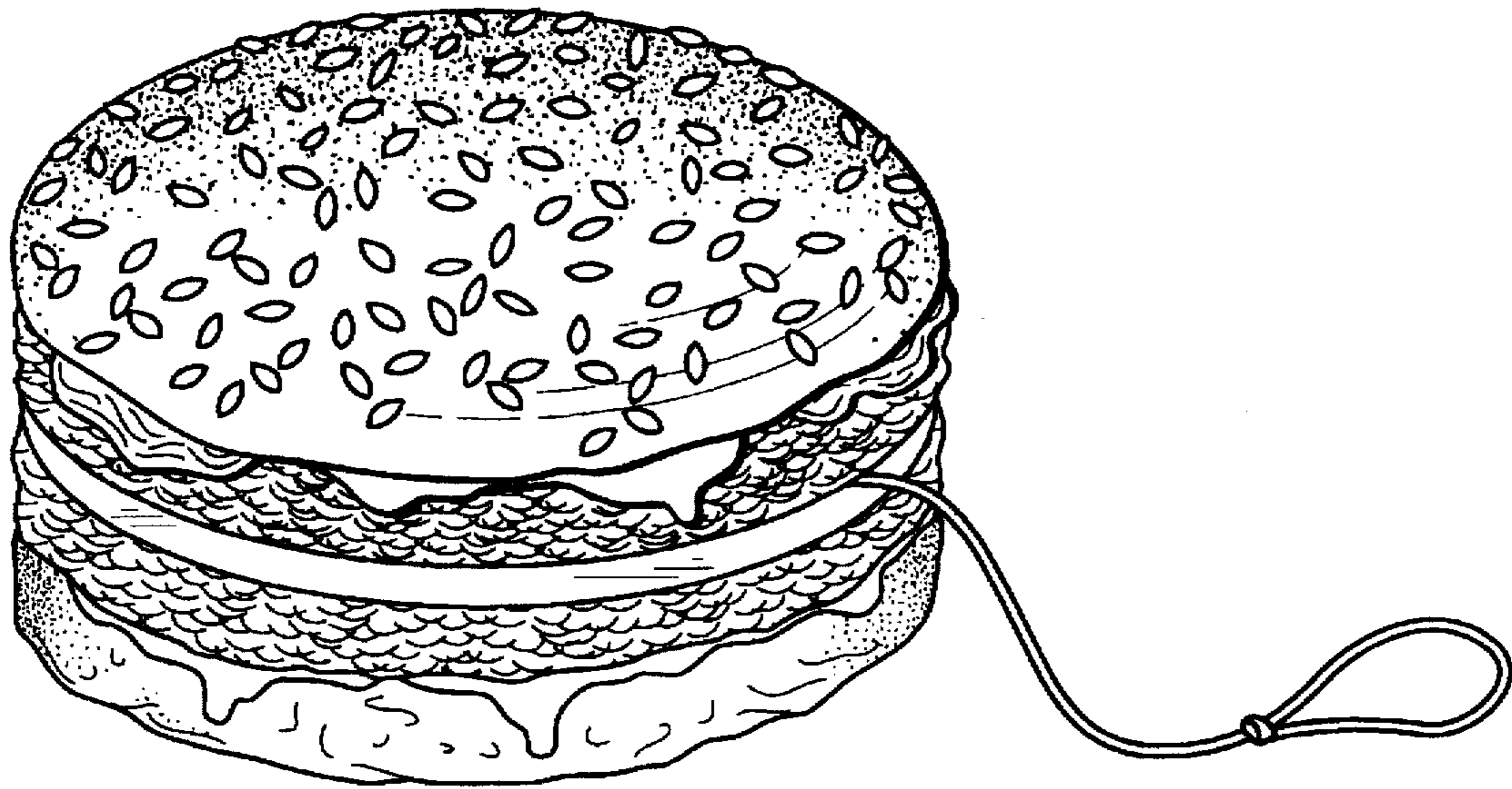

FIG. 1

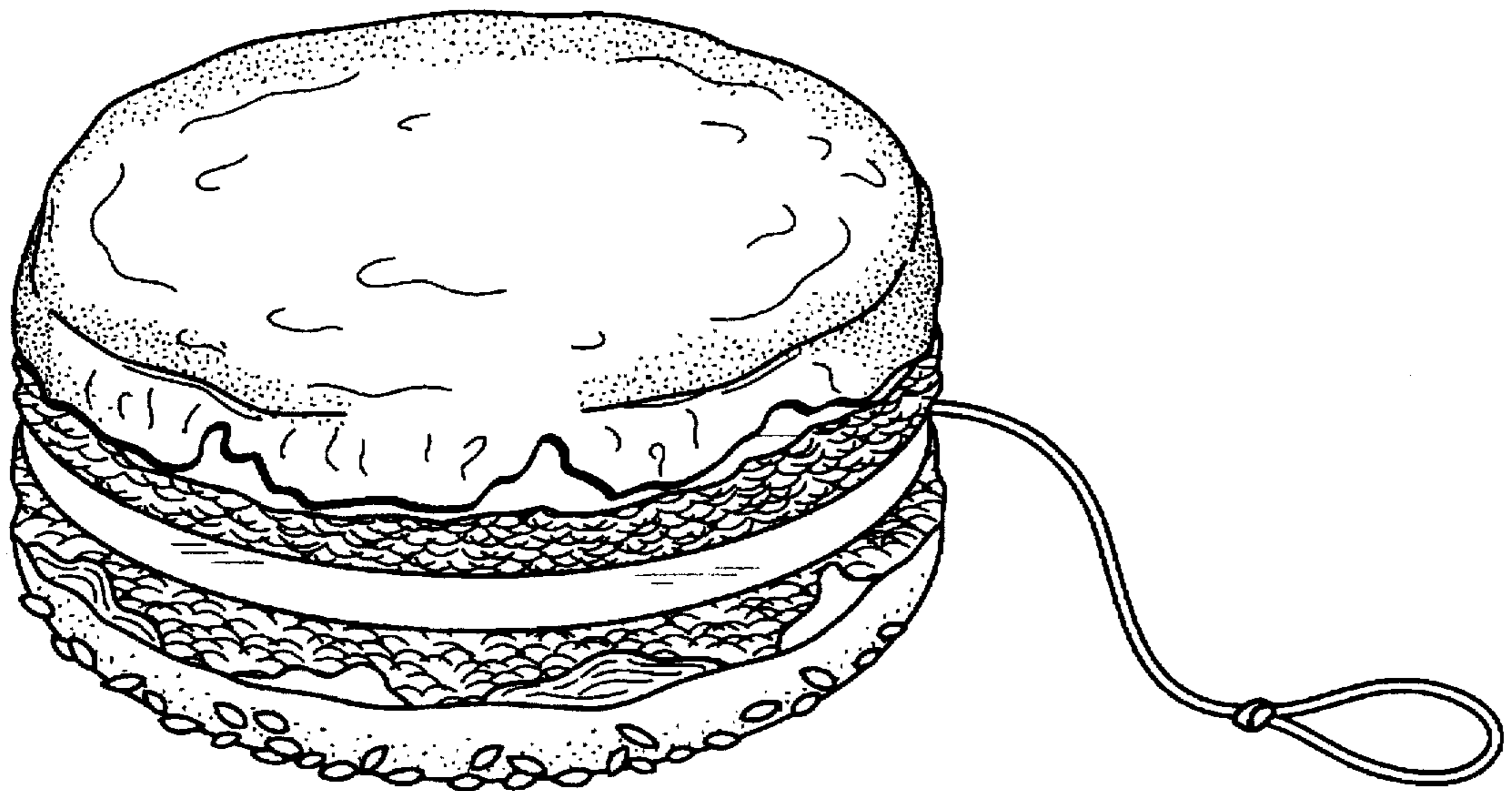

FIG. 2

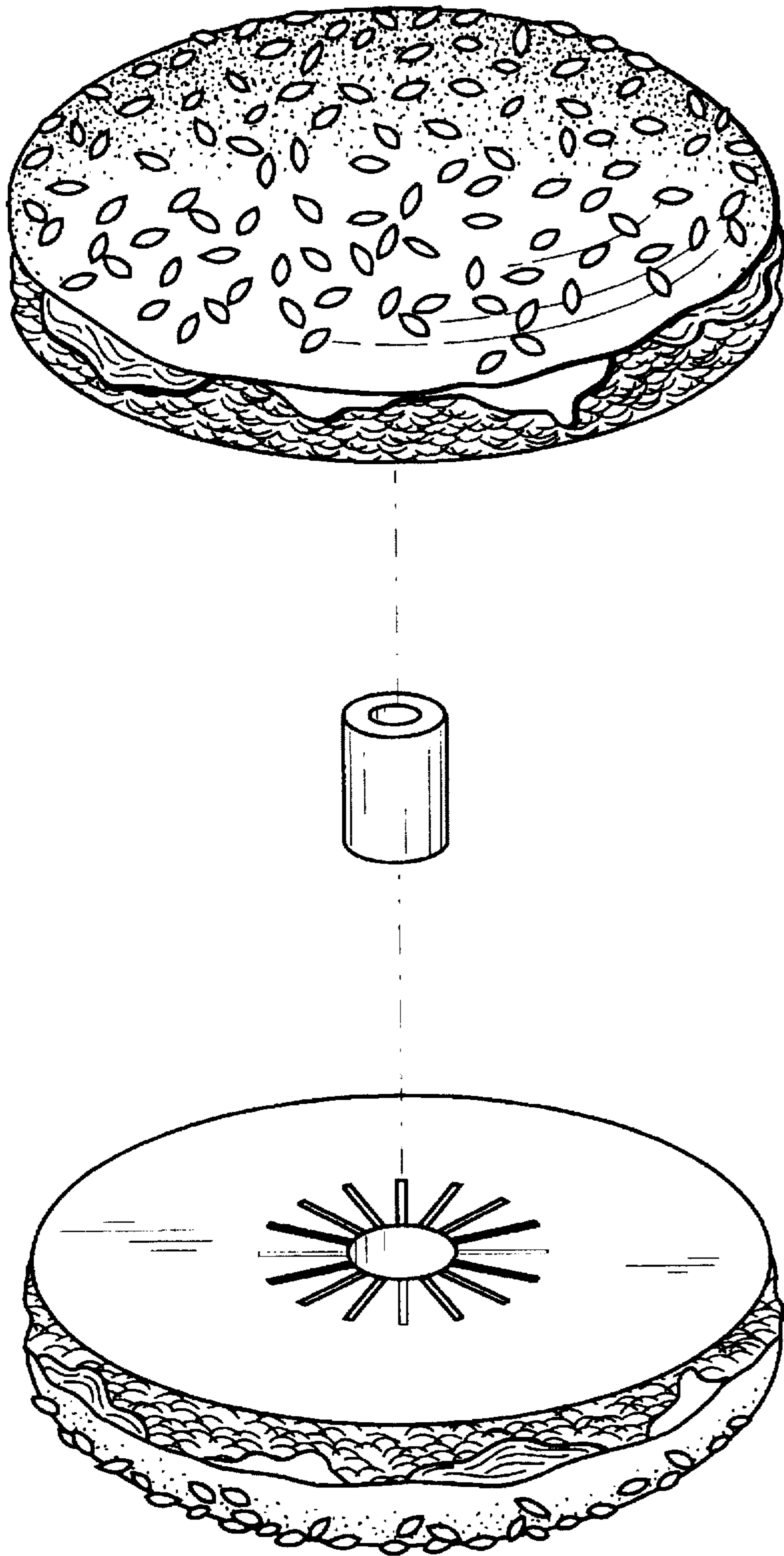

FIG. 3

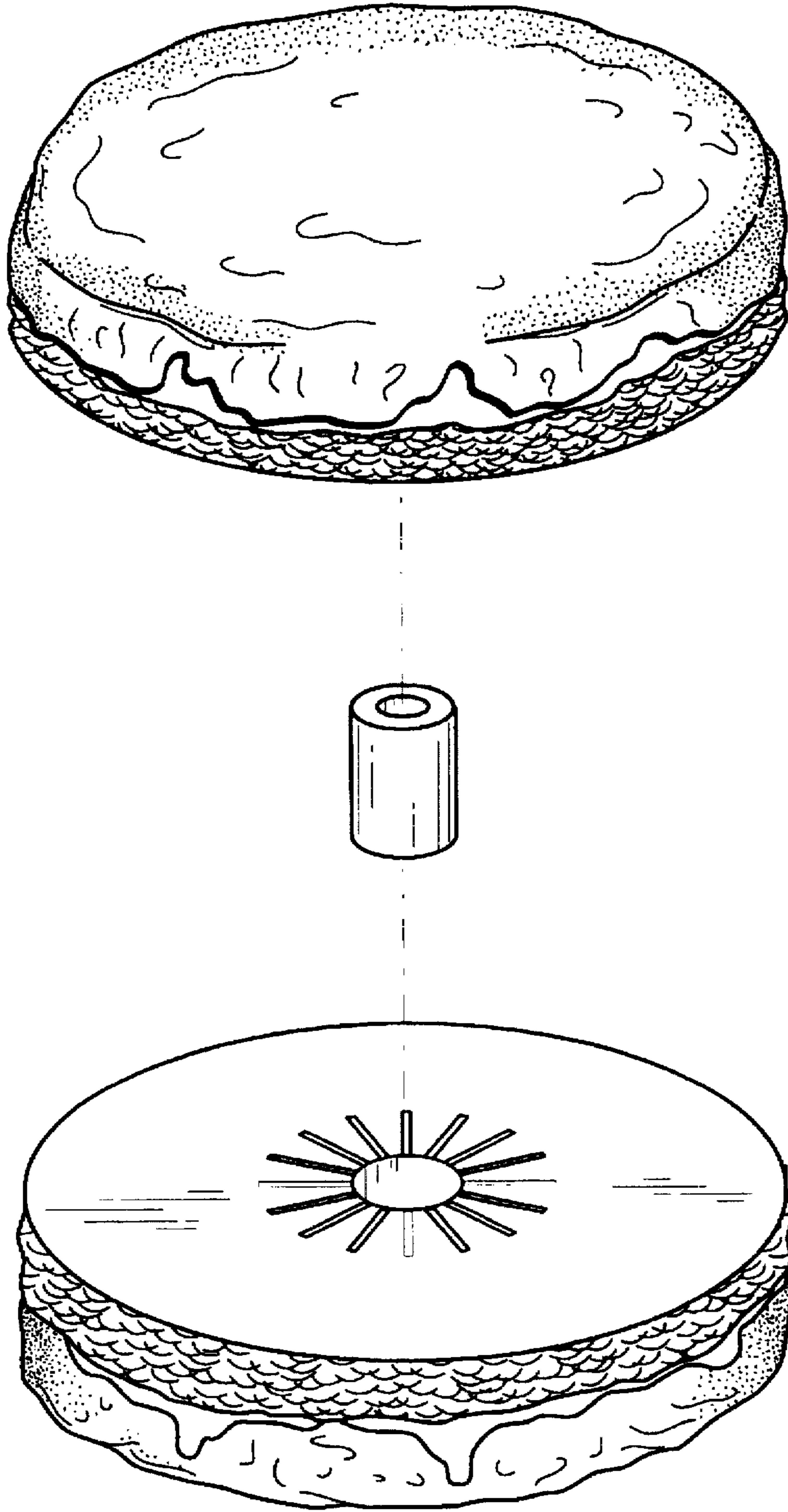

FIG. 4

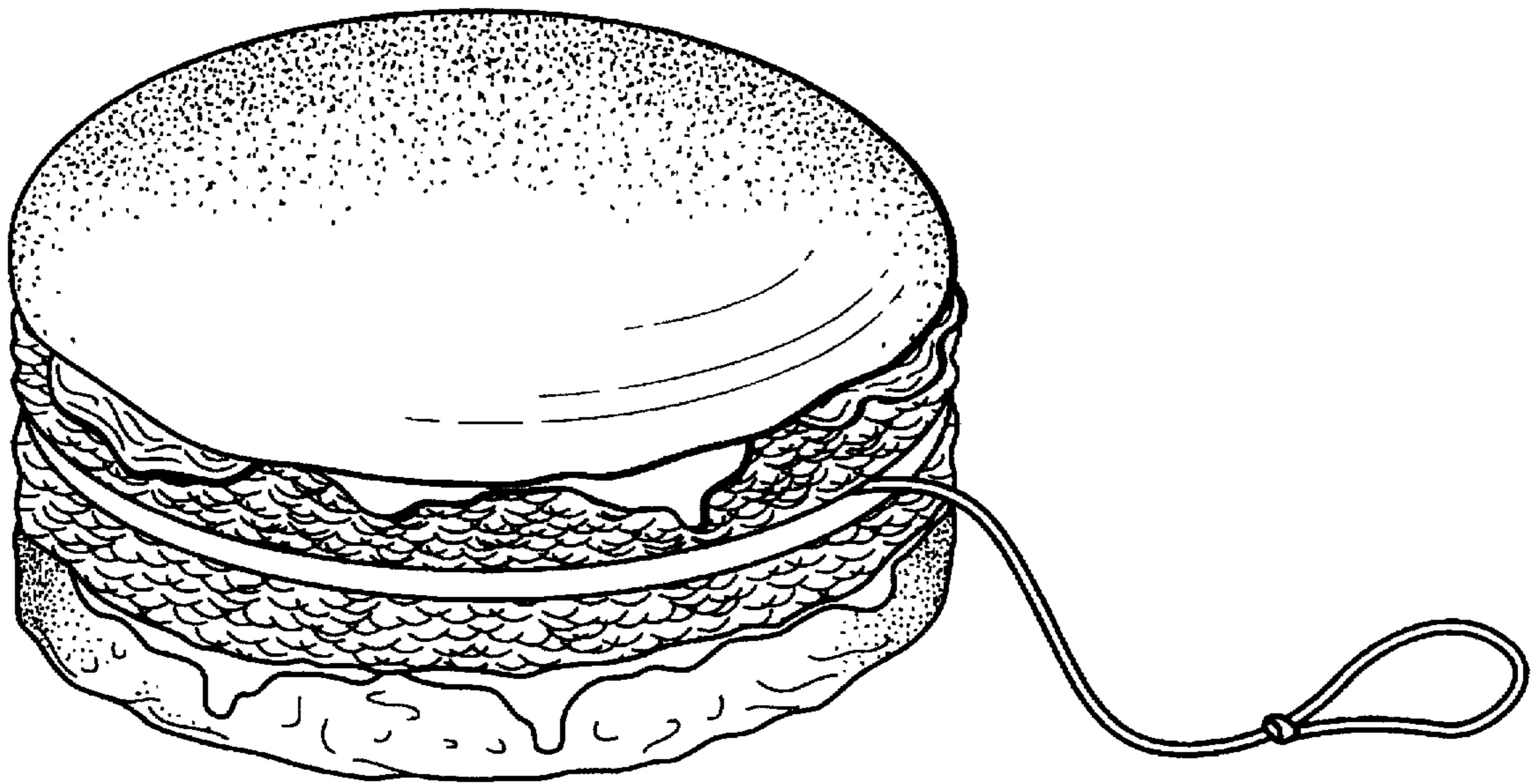

FIG. 5

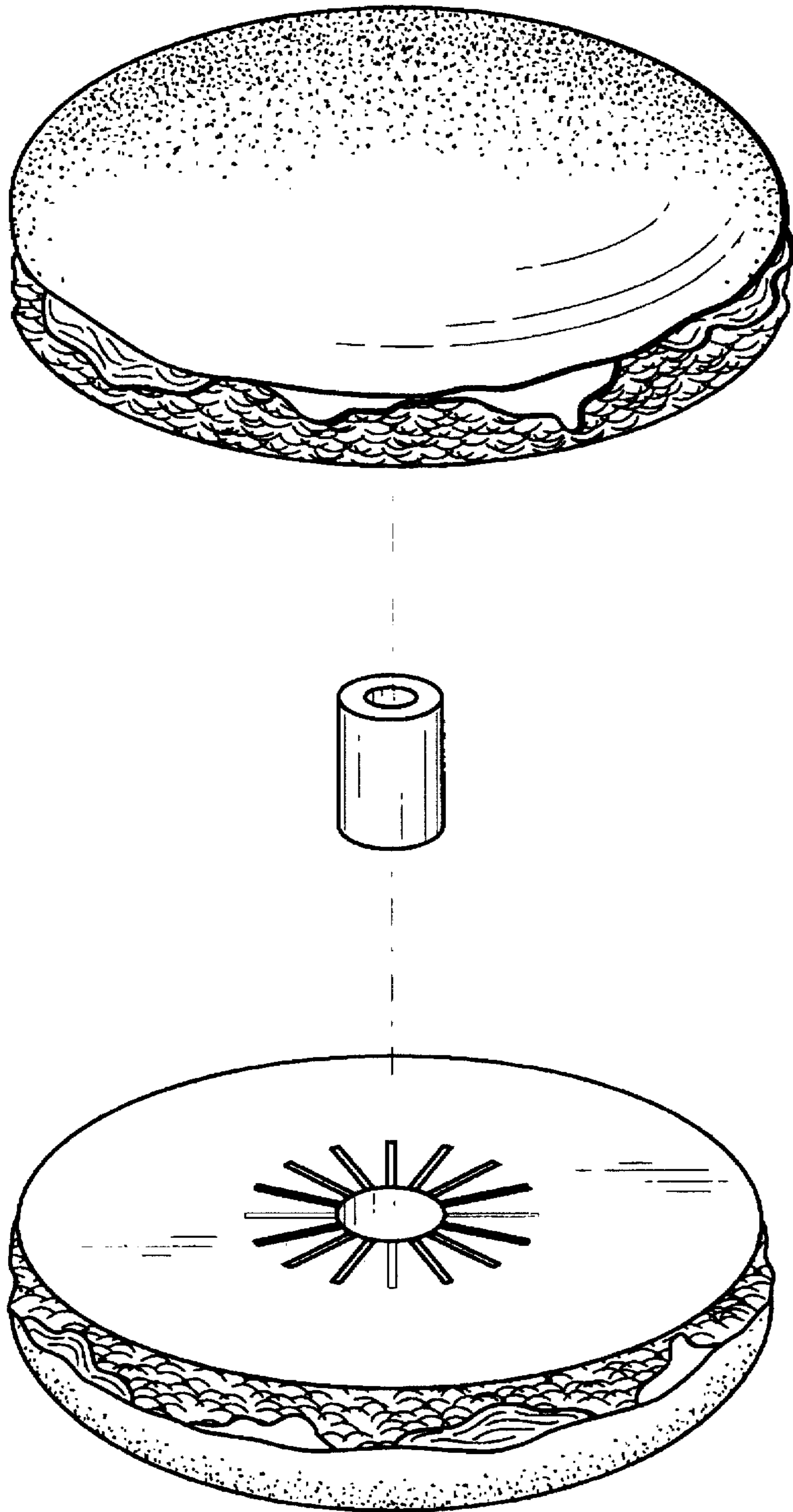

FIG. 6