



US00D389076S

# United States Patent [19]

Beckstrom et al.

[11] Patent Number: Des. 389,076

[45] Date of Patent: \*\*Jan. 13, 1998

[54] SCALE

[75] Inventors: **David W. Beckstrom**, Fairfield; **David W. Davis**, Winsted; **John F. Davison, Jr.**, New Britain; **Robert L. Marvin, Jr.**, Farmington; **Paul W. Porter**, Southbury, all of Conn.

[73] Assignee: **Pitney Bowes Inc.**, Stamford, Conn.

[\*\*] Term: **14 Years**

[21] Appl. No.: **62,358**

[22] Filed: **Nov. 13, 1996**

[51] LOC (6) Cl. .... **10-04**

[52] U.S. Cl. .... **D10/91**

[58] Field of Search ..... **D10/91; 177/25, 177/30, 210 R, 229, 238-241, DIG. 3**

## [56] References Cited

### U.S. PATENT DOCUMENTS

D. 354,691 1/1995 Goldberg et al. .... D10/91  
5,521,334 5/1996 Freeman ..... 177/154

*Primary Examiner*—Antoine Duval Davis

*Attorney, Agent, or Firm*—Angelo N. Chaclos; Steven J. Shapiro; Melvin J. Scolnick

## [57] CLAIM

The ornamental design for a scale, as shown and described.

### DESCRIPTION

FIG. 1 is a top, front and right side perspective view of a scale in accordance with a first embodiment of the new design;

FIG. 2 is a top plan view in accordance with the first embodiment thereof;

FIG. 3 is a right side view in accordance with the first embodiment thereof and the left side view is a mirror image of the right side view;

FIG. 4 is a front elevational view in accordance with the first embodiment view thereof;

FIG. 5 is a rear elevational view in accordance with the first embodiment thereof; and

FIG. 6 is a top, front and right side perspective view of a scale in accordance with a second embodiment of the new design;

FIG. 7 is a top plan view in accordance with the second embodiment thereof;

FIG. 8 is a right side view in accordance with the second embodiment thereof and the left side view is a mirror image of the right side view except for the arrangement of which keys are visible in the left side view;

FIG. 9 is a front elevational view in accordance with the second embodiment thereof;

FIG. 10 is a rear elevational view in accordance with the second embodiment thereof; and

FIG. 11 is a top, front and right side perspective view of a scale in accordance with a third embodiment of the new design;

FIG. 12 is a top plan view in accordance with the third embodiment thereof;

FIG. 13 is a right side view in accordance with the third embodiment thereof and the left side view is a mirror image of the right side view except for the arrangement of which keys are visible in the left side view;

FIG. 14 is a front elevational view in accordance with the third embodiment thereof;

FIG. 15 is a rear elevational view in accordance with the third embodiment thereof; and

FIG. 16 is a top, front and right side perspective view of a scale in accordance with a fourth embodiment of the new design;

FIG. 17 is a top plan view in accordance with the fourth embodiment thereof;

FIG. 18 is a right side view in accordance with the fourth embodiment thereof and the left side view is a mirror image of the right side view except for the arrangement of which keys are visible in the left side view;

FIG. 19 is a front elevational view in accordance with the fourth embodiment thereof; and,

FIG. 20 is a rear elevational view in accordance with the fourth embodiment thereof.

**1 Claim, 20 Drawing Sheets**

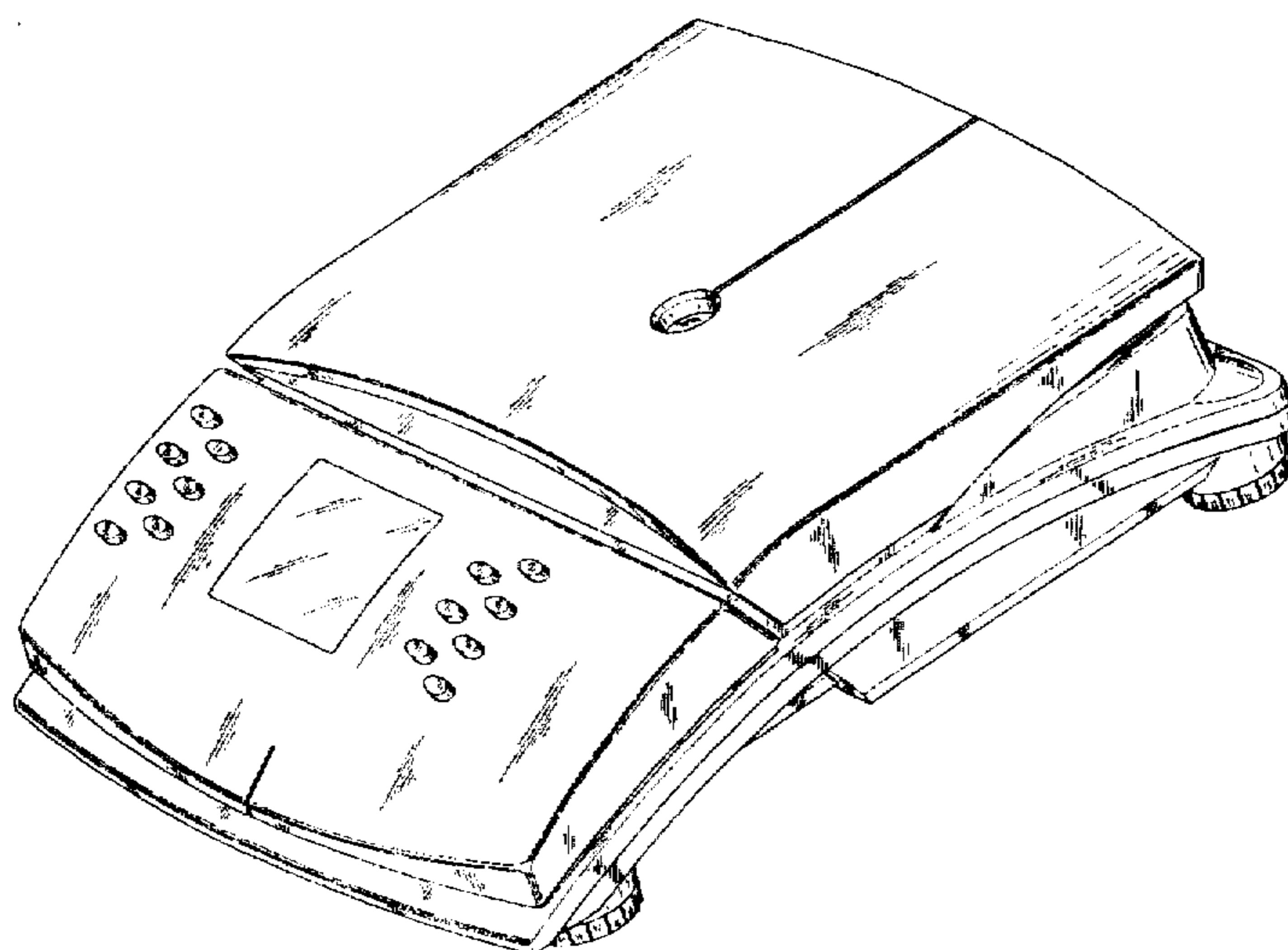

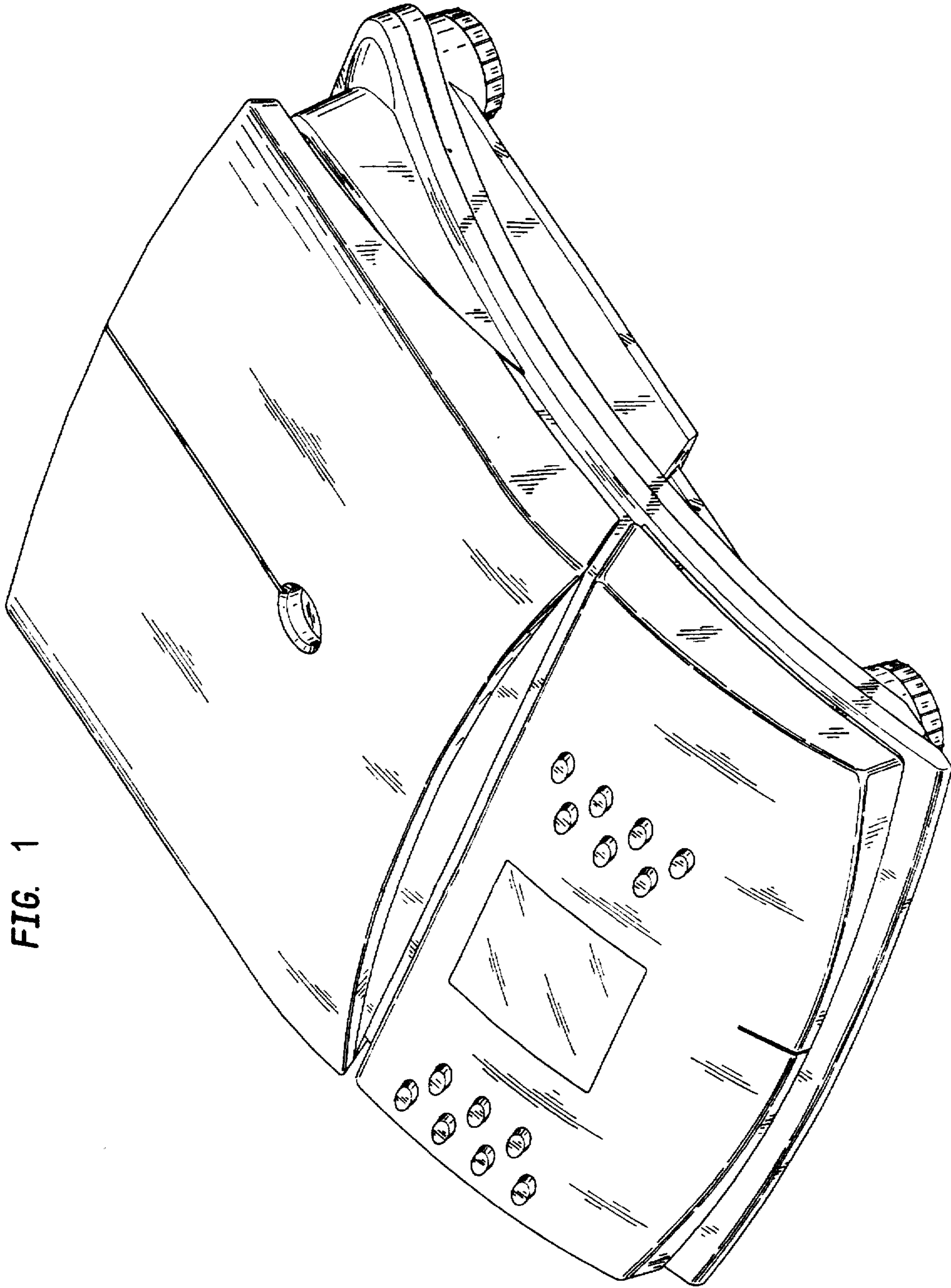

FIG. 1

FIG. 2

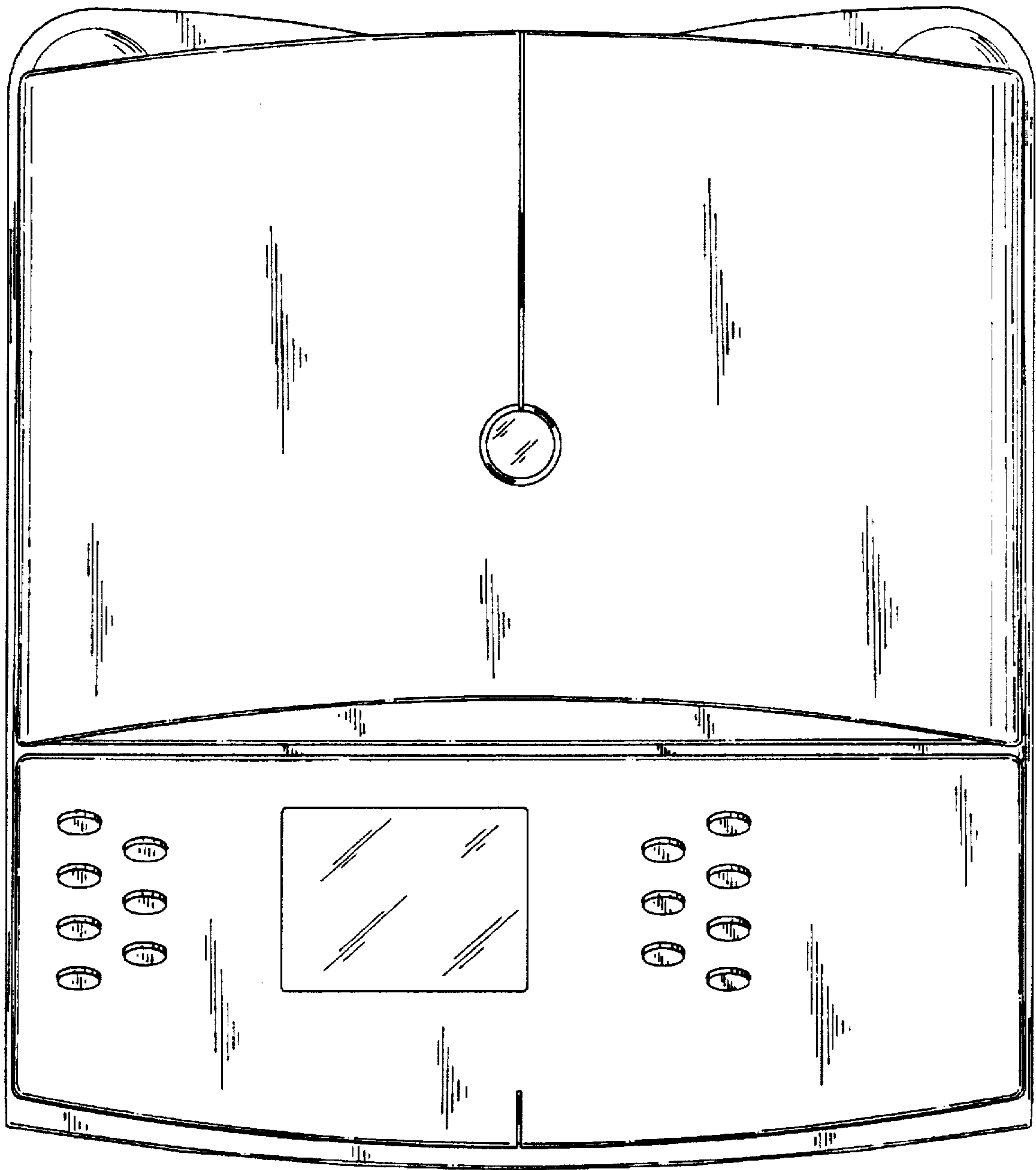

FIG. 3

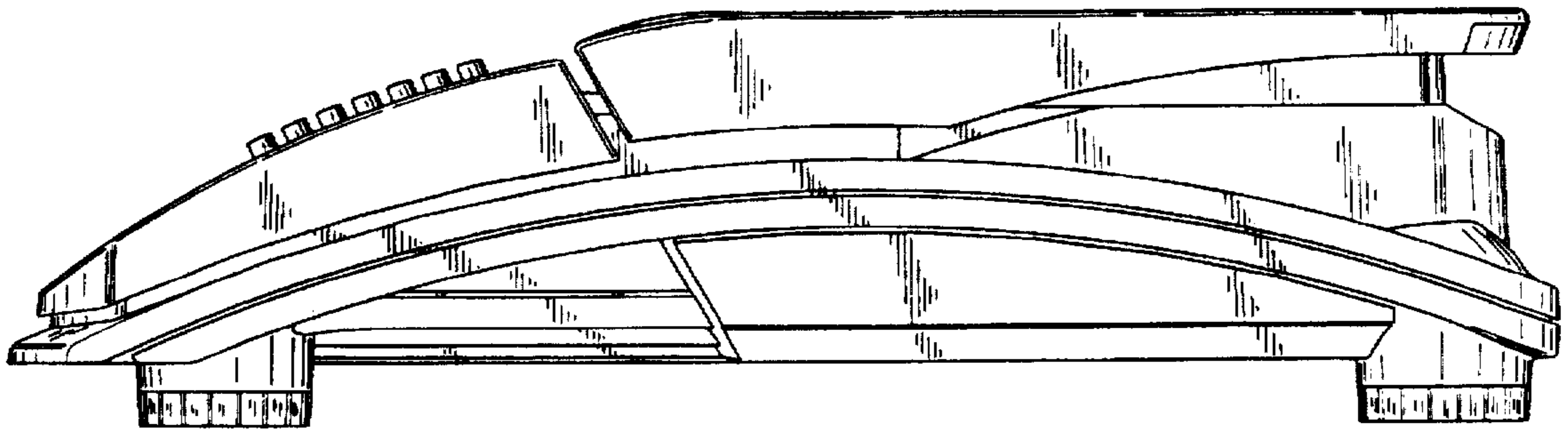

FIG. 4

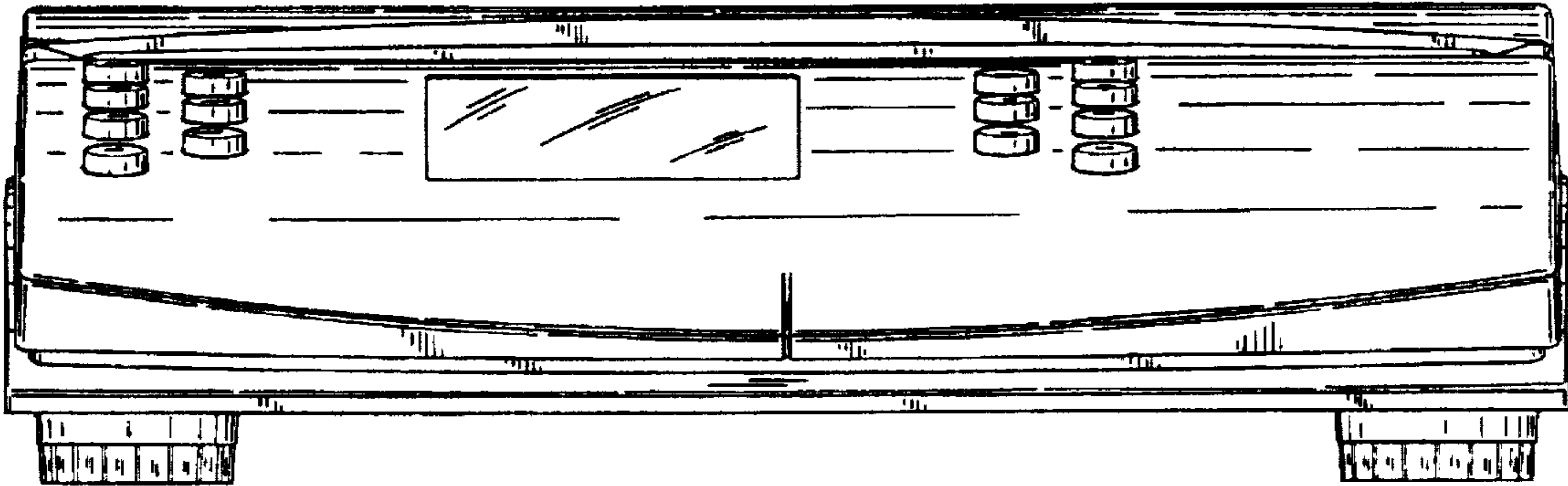
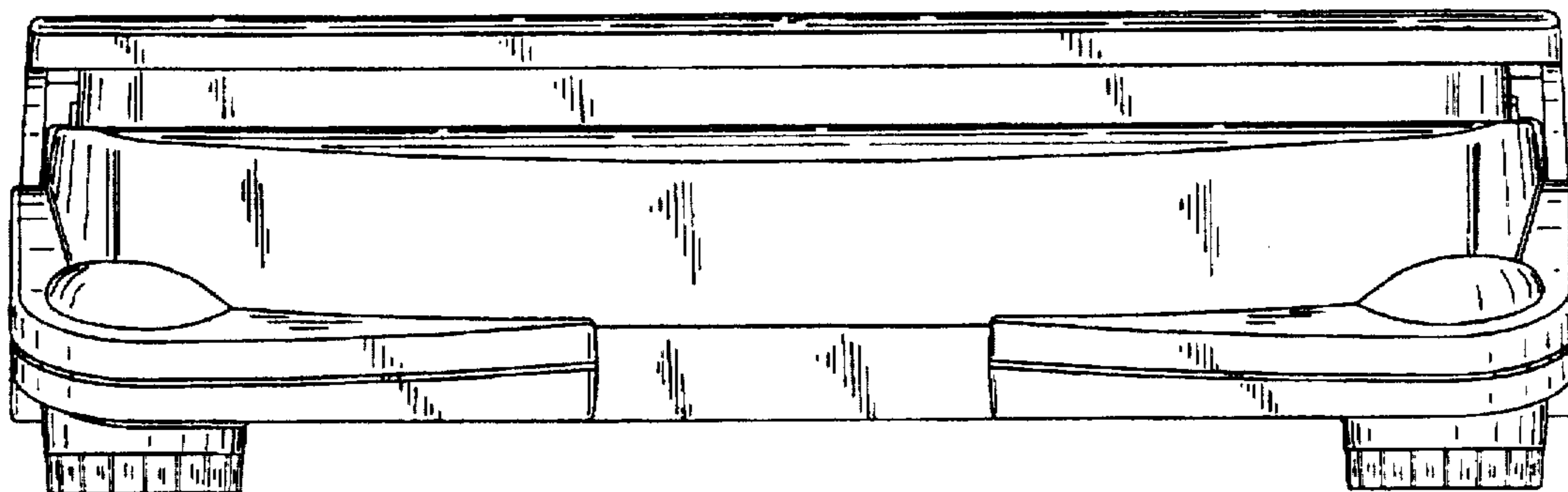

FIG. 5



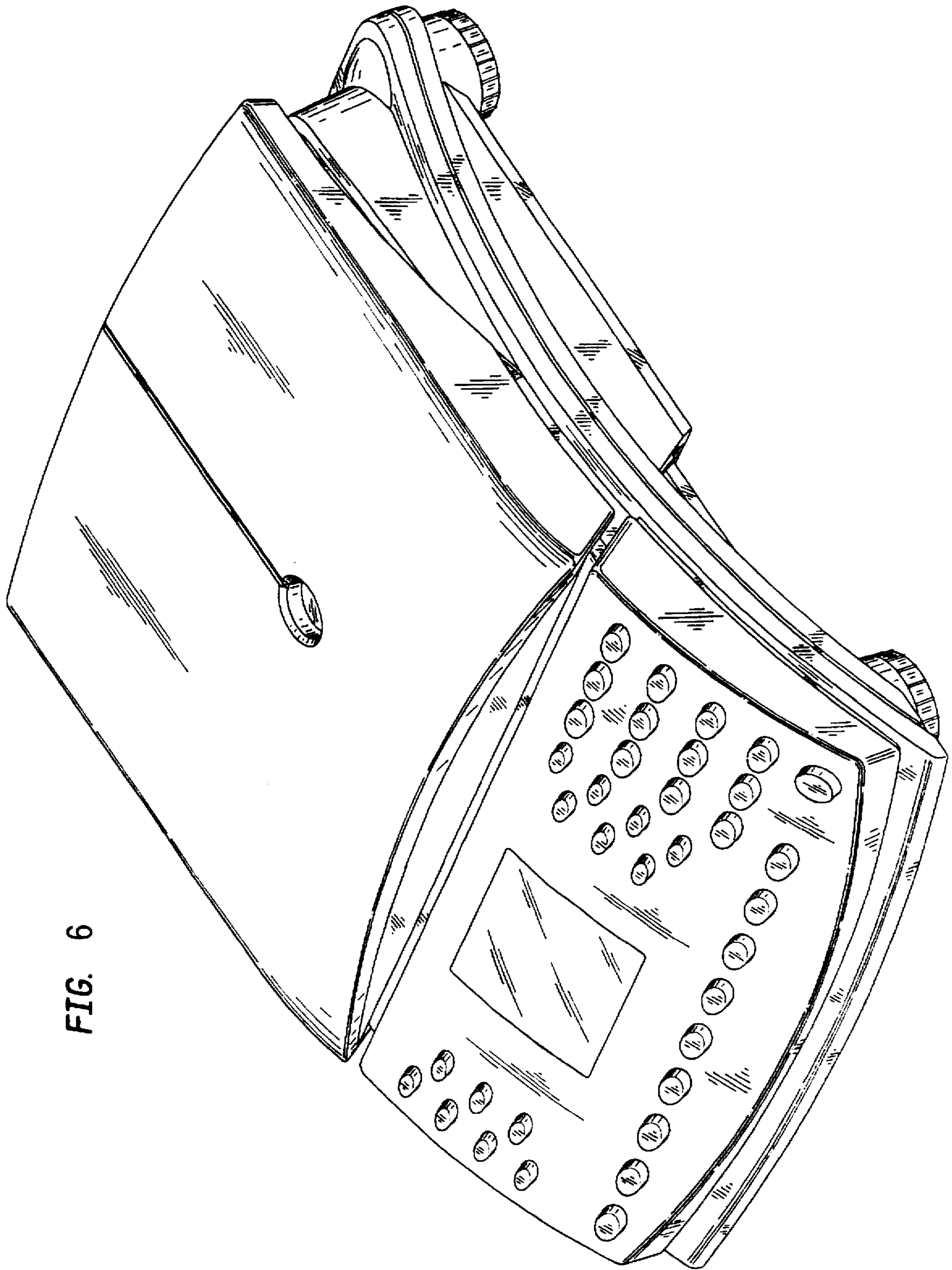

FIG. 6

FIG. 7

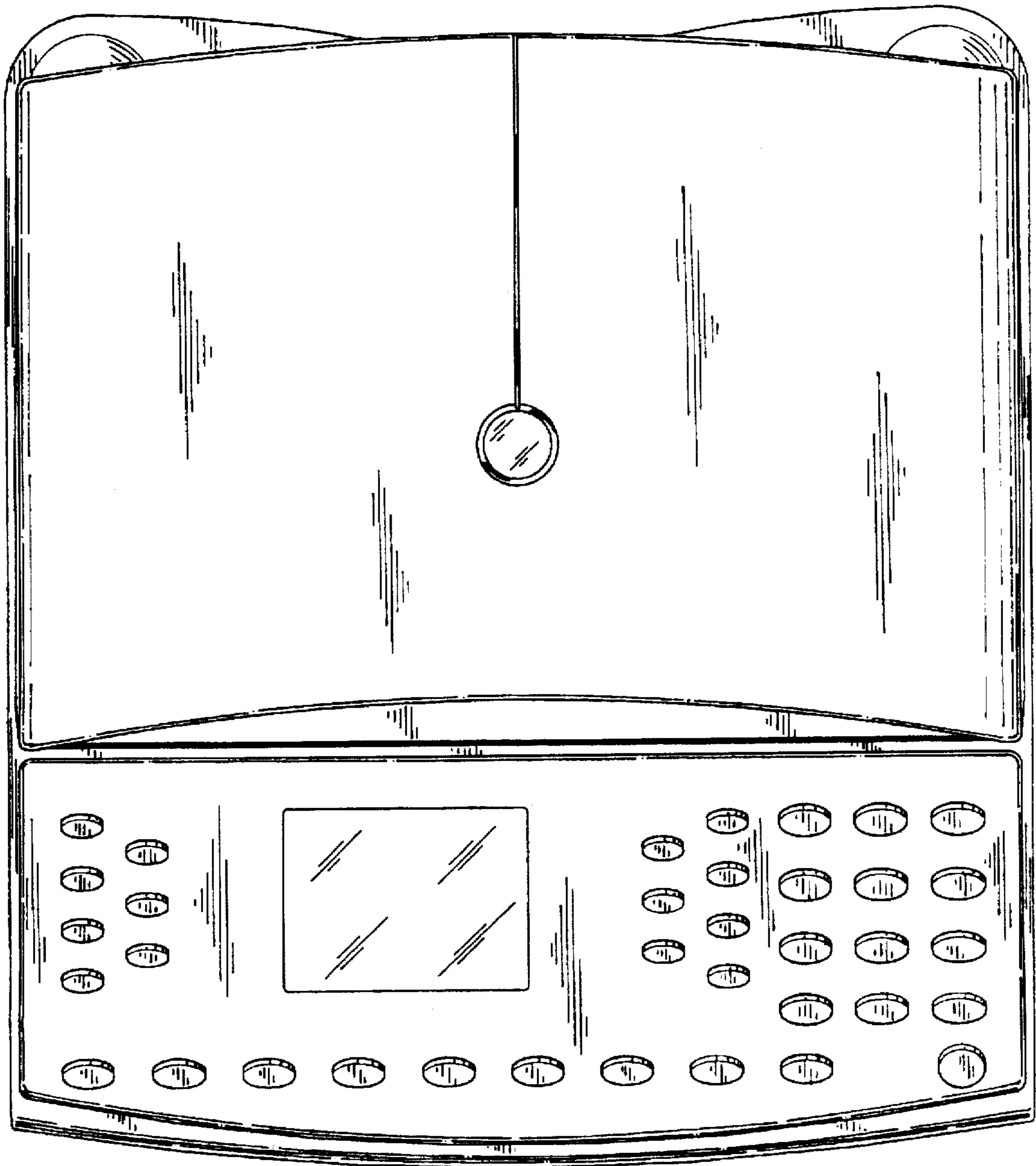



FIG. 8

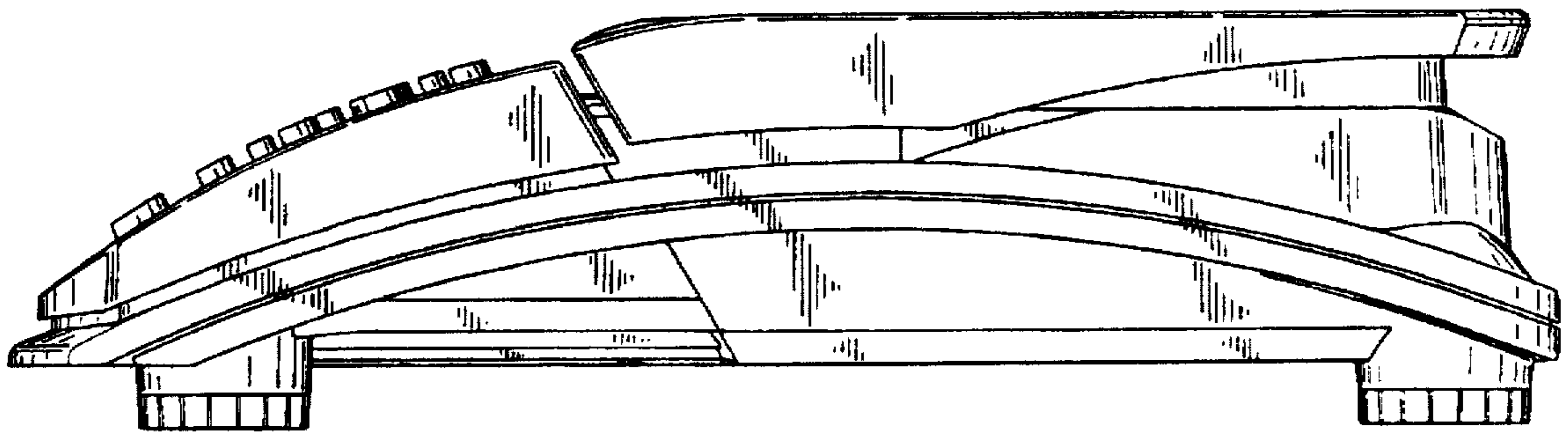

FIG. 9

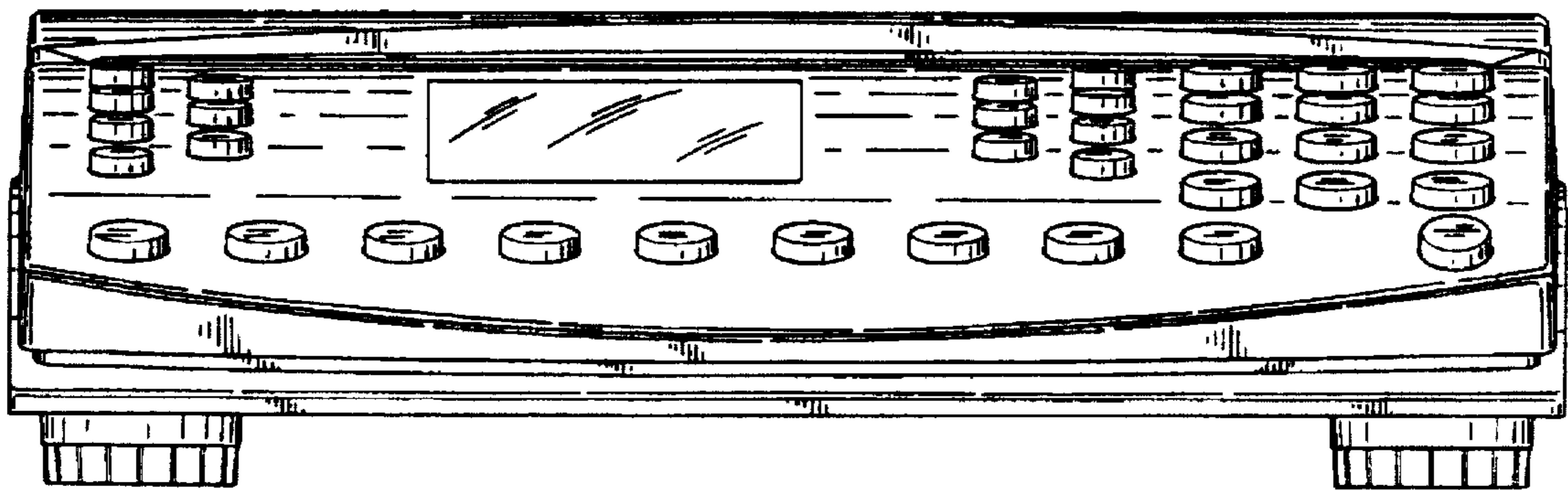
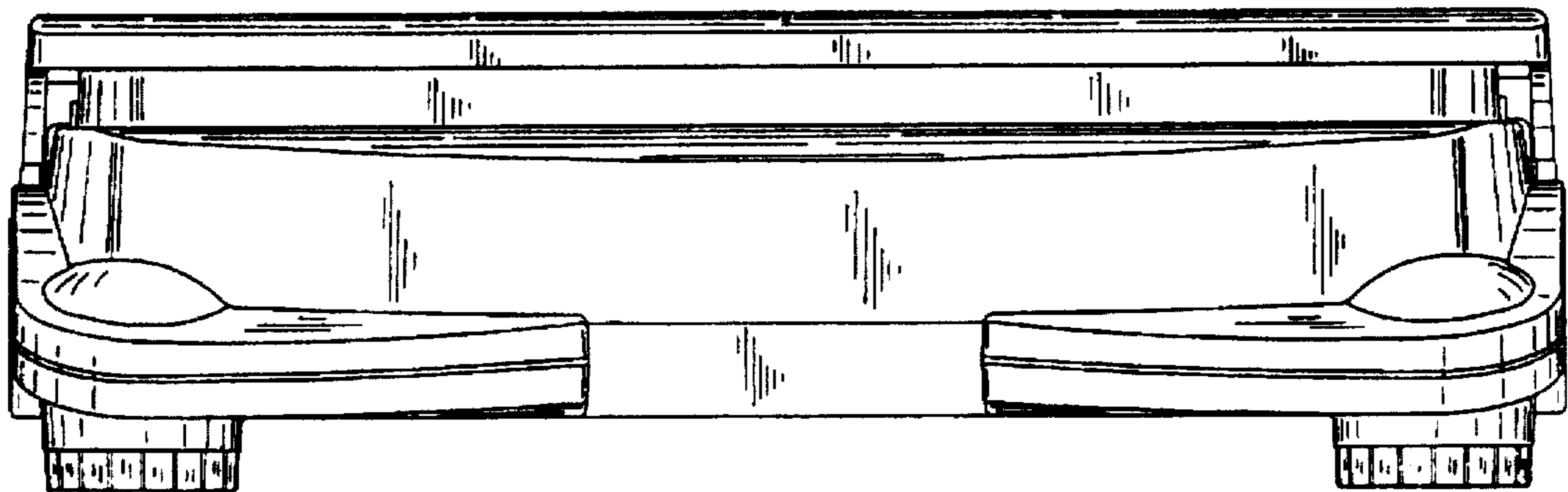

FIG. 10



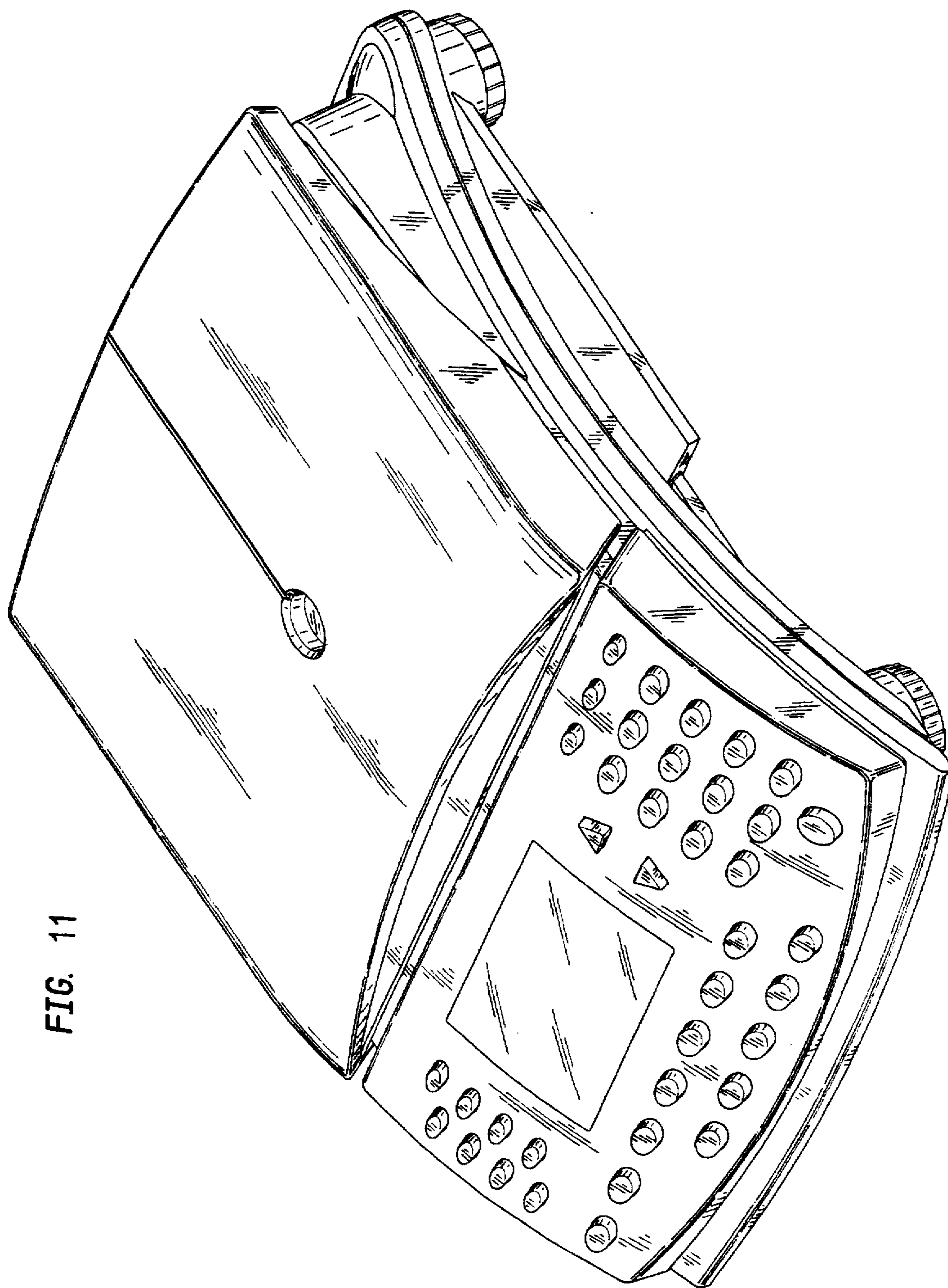

FIG. 11

FIG. 12

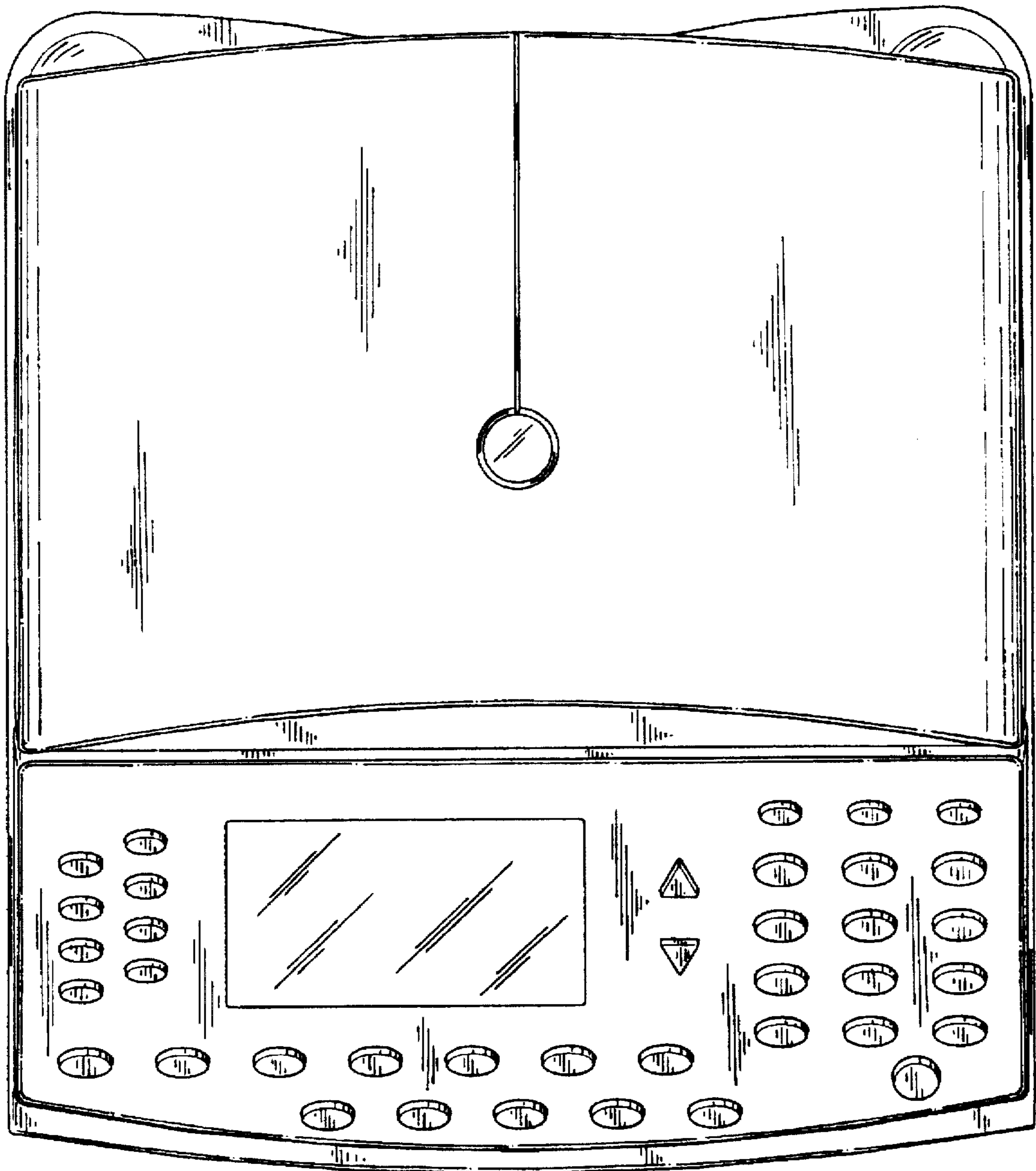

FIG. 13

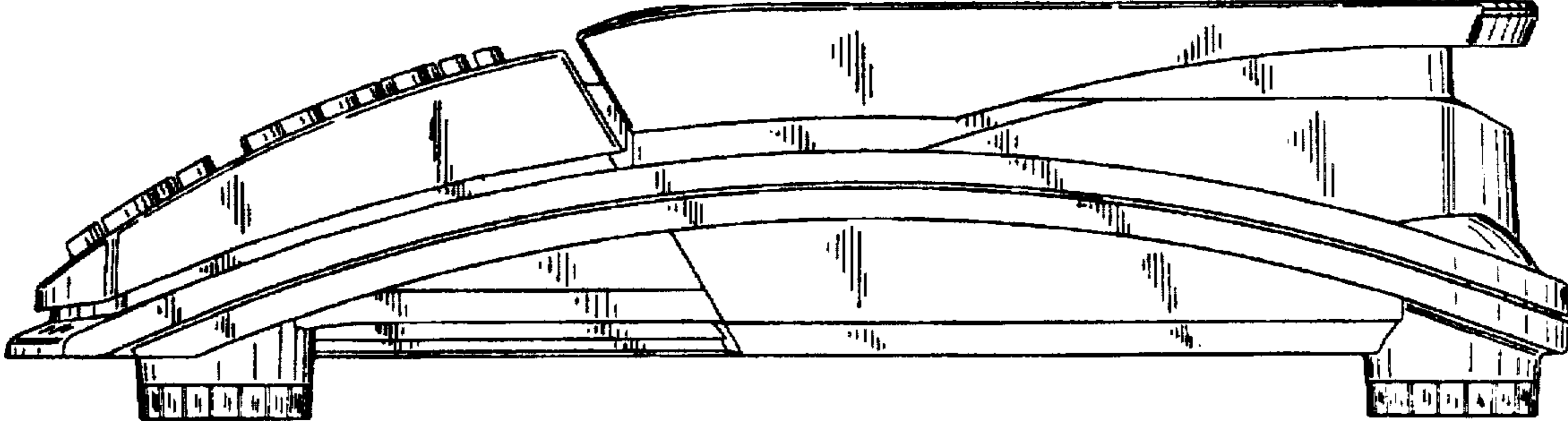

FIG. 14

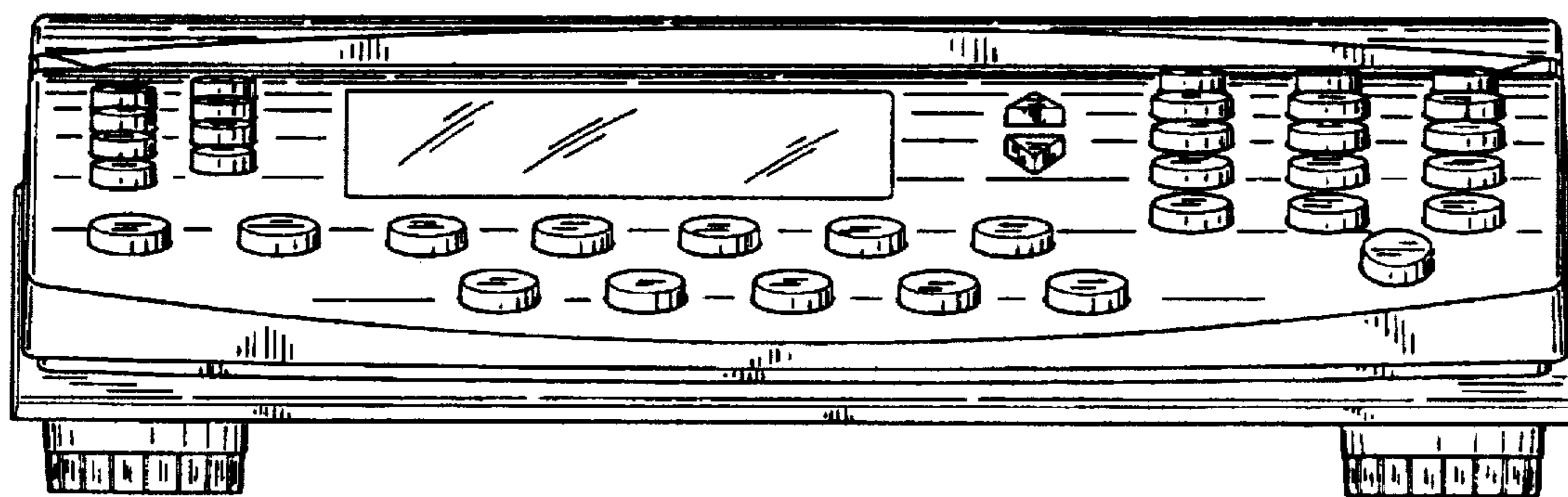
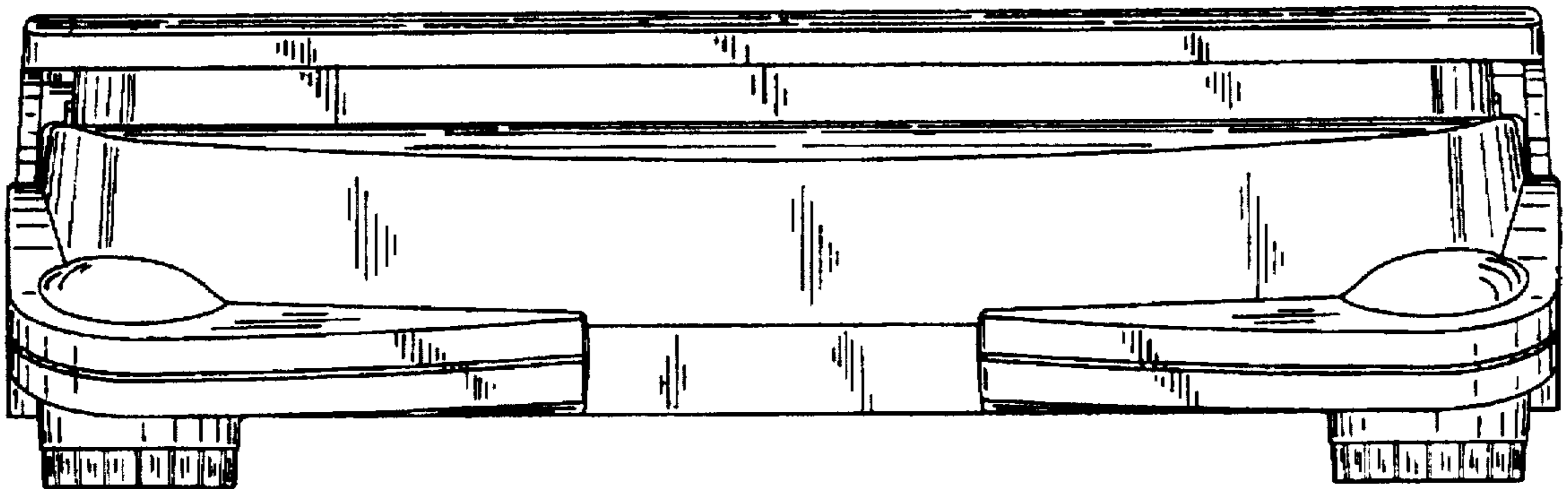

FIG. 15





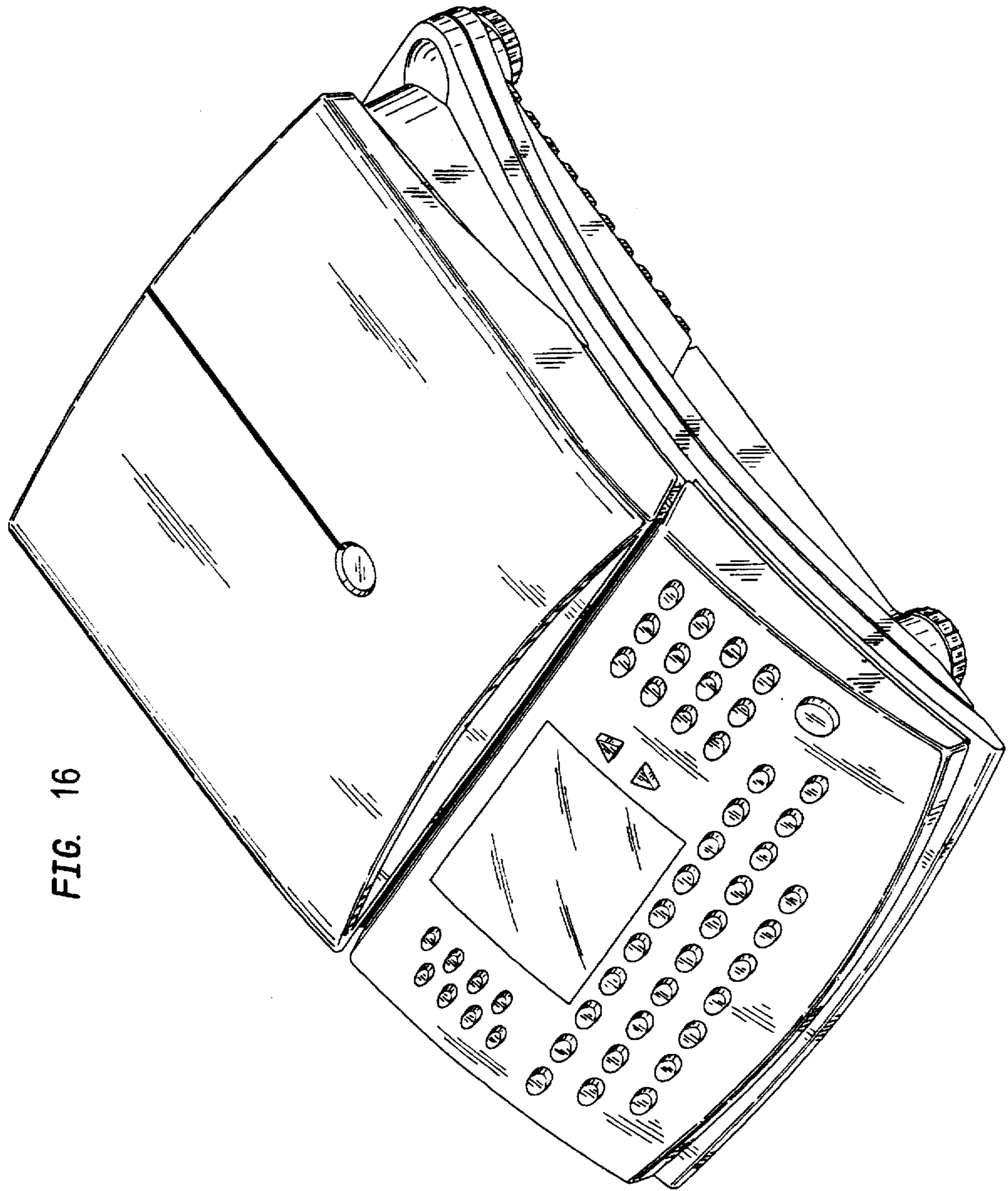

FIG. 16

FIG. 17

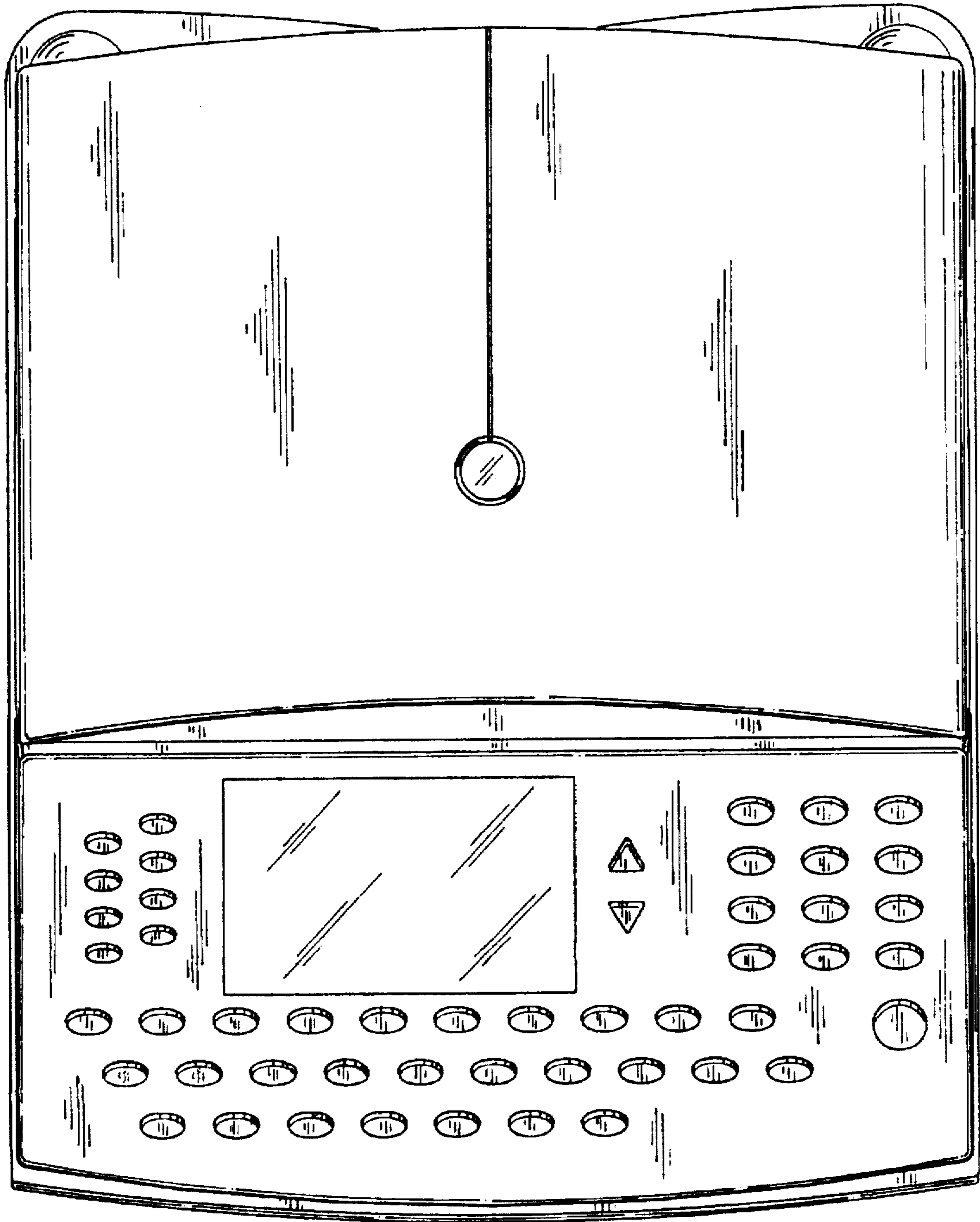

FIG. 18

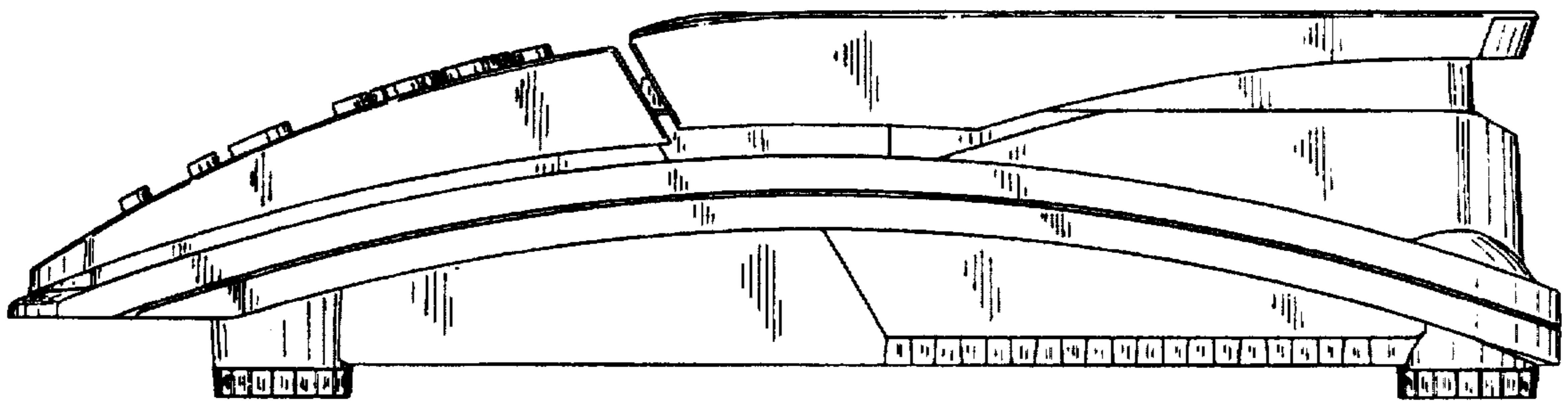

FIG. 19

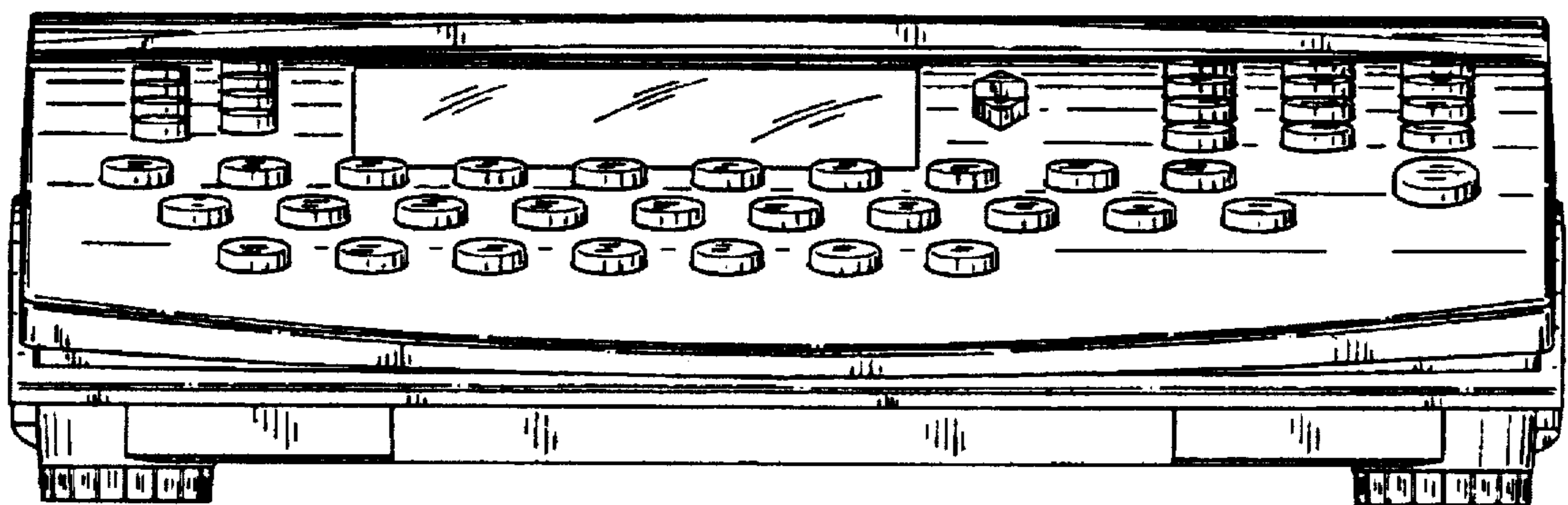

FIG. 20

