



US00D389049S

United States Patent [19]
Kalat

[11] **Patent Number: Des. 389,049**
[45] **Date of Patent: **Jan. 13, 1998**

[54] **REINFORCING ROD FASTENER**
[75] **Inventor: Edward W. Kalat, Southington, Conn.**
[73] **Assignee: Southington Tool & Mfg. Corp., Plantsville, Conn.**
[**] **Term: 14 Years**
[21] **Appl. No.: 41,810**
[22] **Filed: Jul. 25, 1995**
[51] **LOC (6) Cl. 08-08**
[52] **U.S. Cl. D8/382**
[58] **Field of Search D8/354, 382, 384; 52/665, 685, 712, 719; 248/218.4**

3,356,399 12/1967 Young 52/712 X
5,392,581 2/1995 Hatzinikolas et al. 52/712

Primary Examiner—Terry A. Wallace
Attorney, Agent, or Firm—Chilton, Alix & Van Kirk

[57] **CLAIM**

The ornamental design for a reinforcing rod fastener, as shown and described.

DESCRIPTION

FIG. 1 is a top view of a reinforcing rod fastener showing my new design;
FIG. 2 is a front view thereof;
FIG. 3 is a rear view thereof;
FIG. 4 is a bottom view thereof;
FIG. 5 is a left side view thereof, the right side thereof being a mirror image; and,
FIG. 6 is a perspective view thereof, the broken lines are shown for illustrative purposes only and form no part of the claimed design.

[56] **References Cited**
U.S. PATENT DOCUMENTS
1,805,797 5/1931 Bates 52/712 X
1,999,508 4/1935 Mathews 52/719
3,161,263 12/1964 Stokes 248/218.4

1 Claim, 2 Drawing Sheets

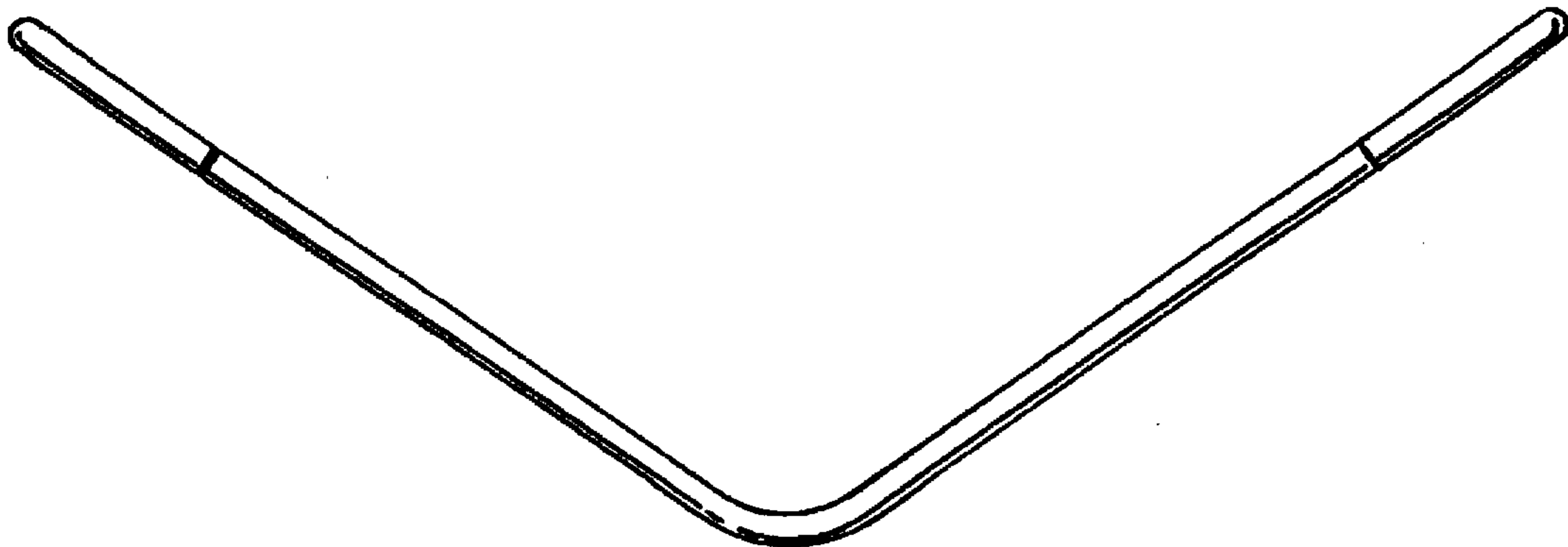
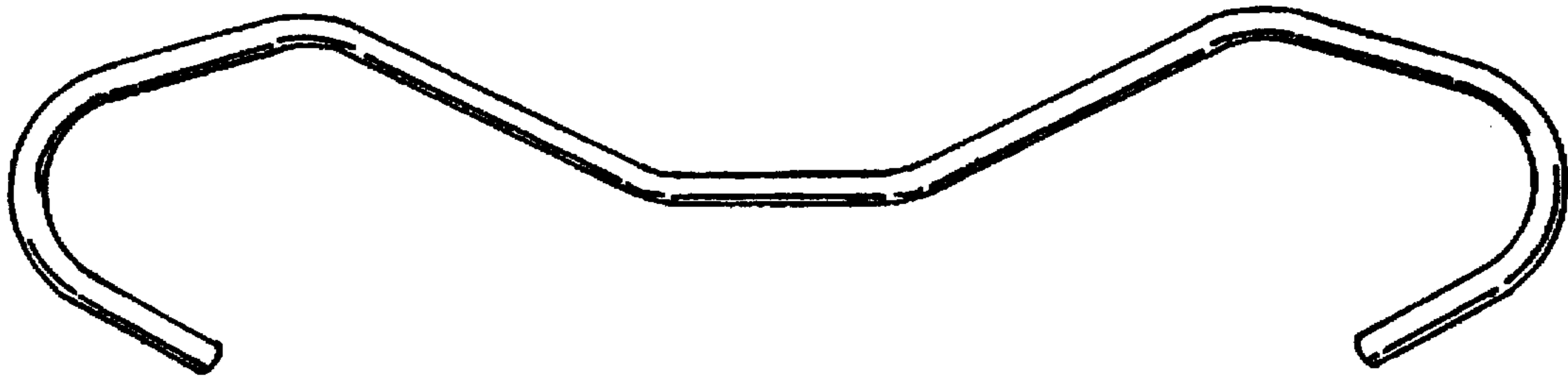

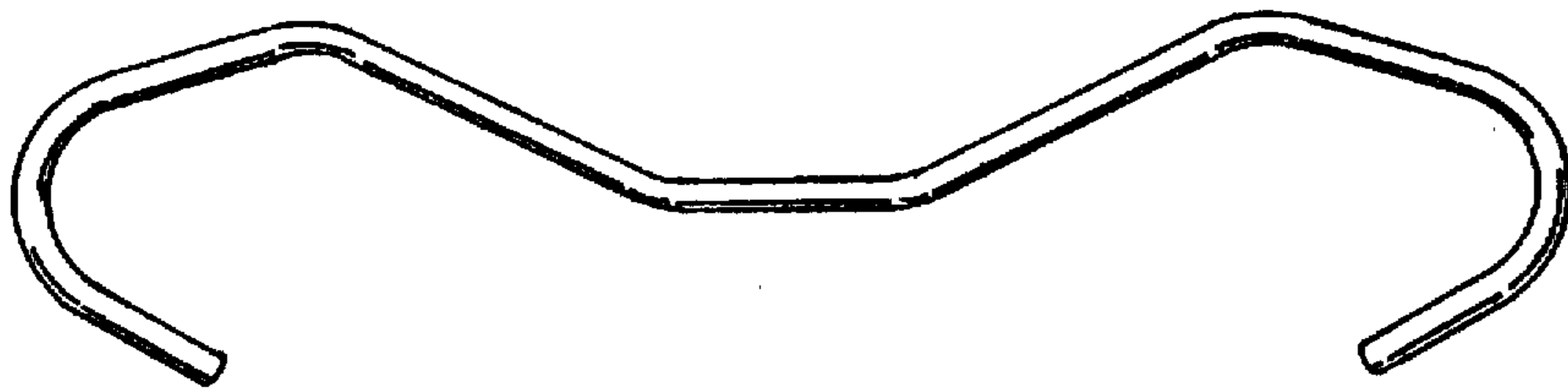

FIG. 1

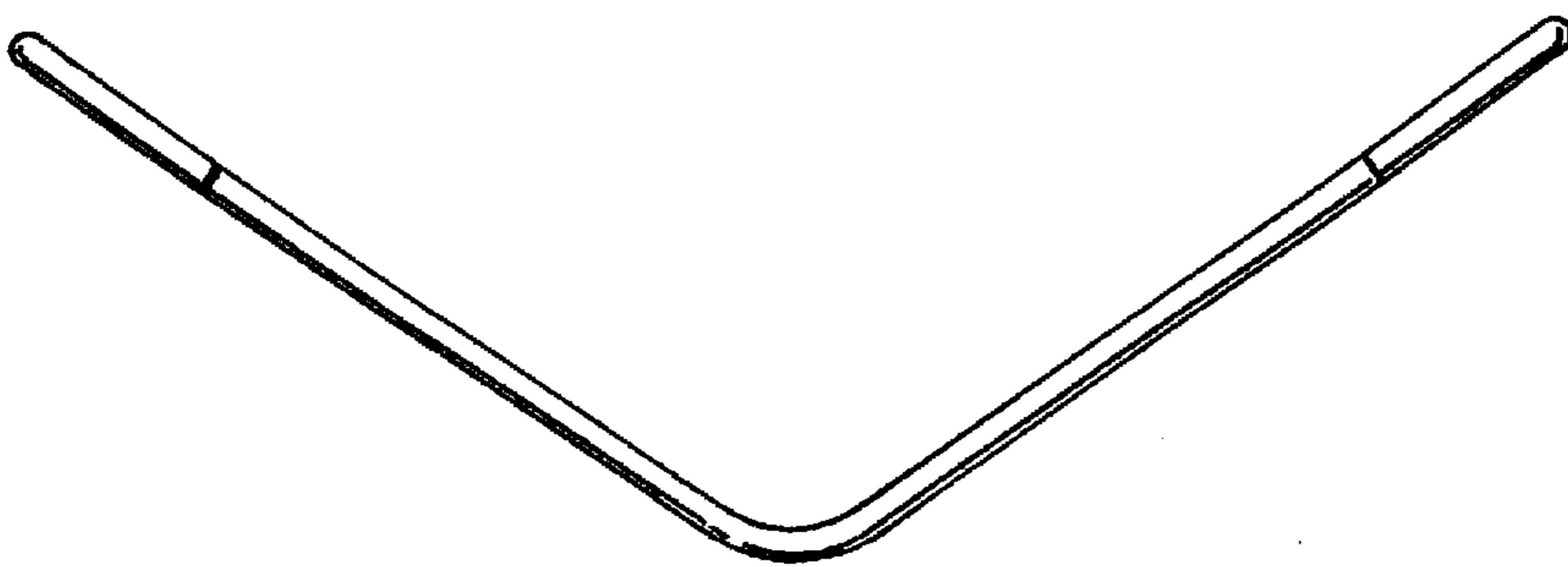

FIG. 2

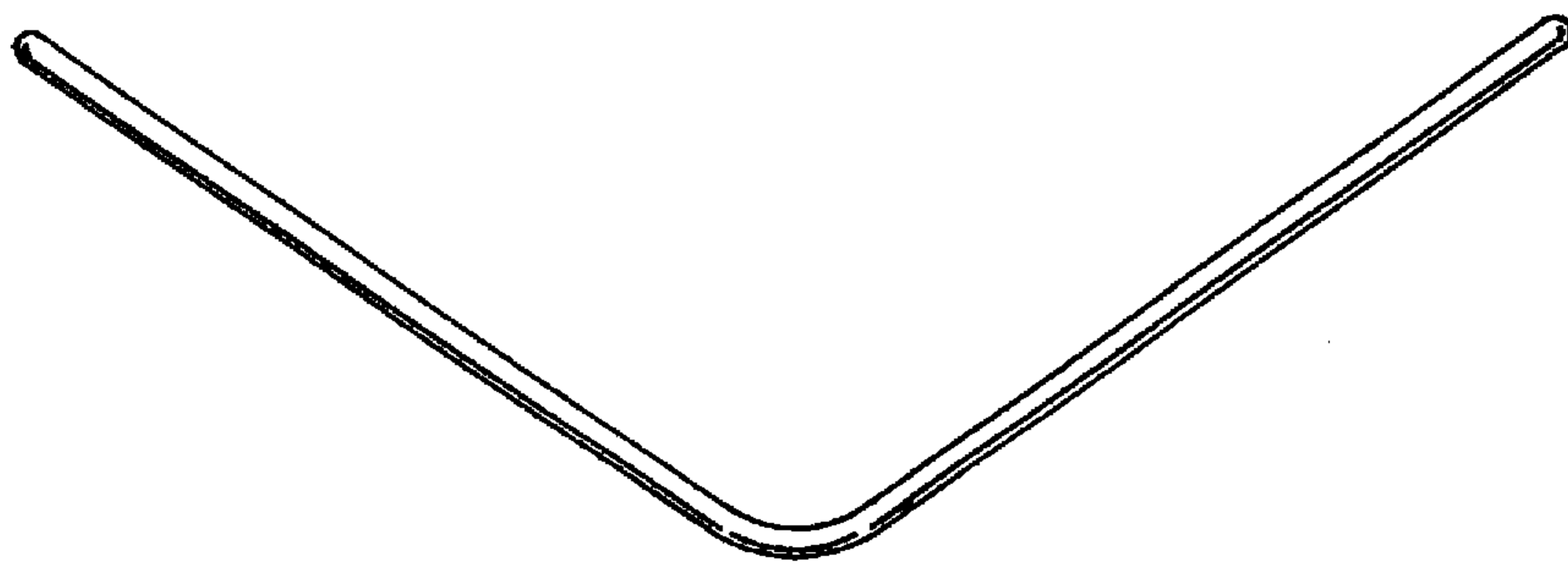

FIG. 3

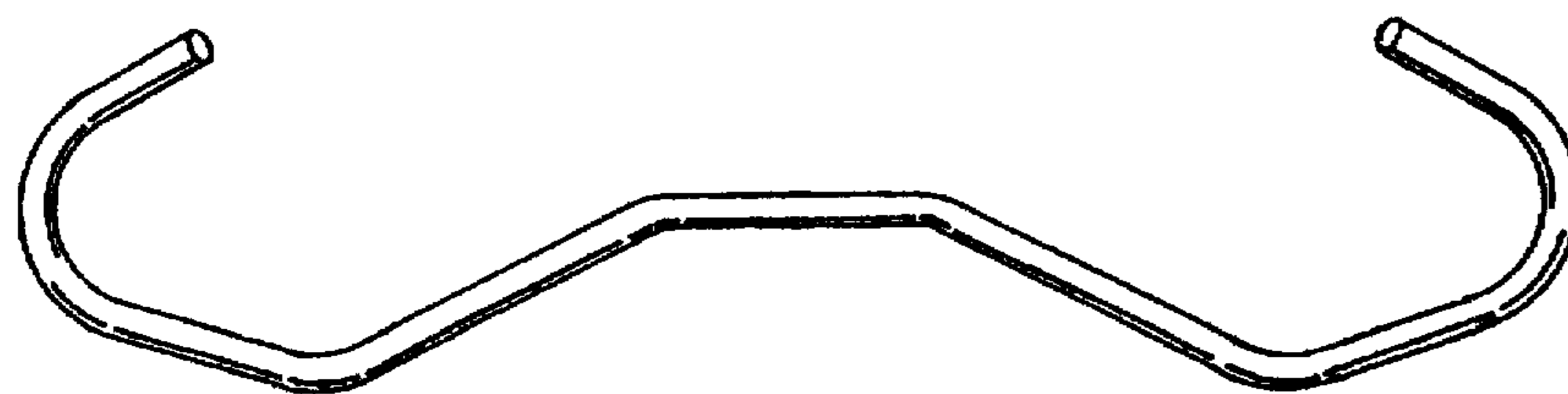

FIG. 4

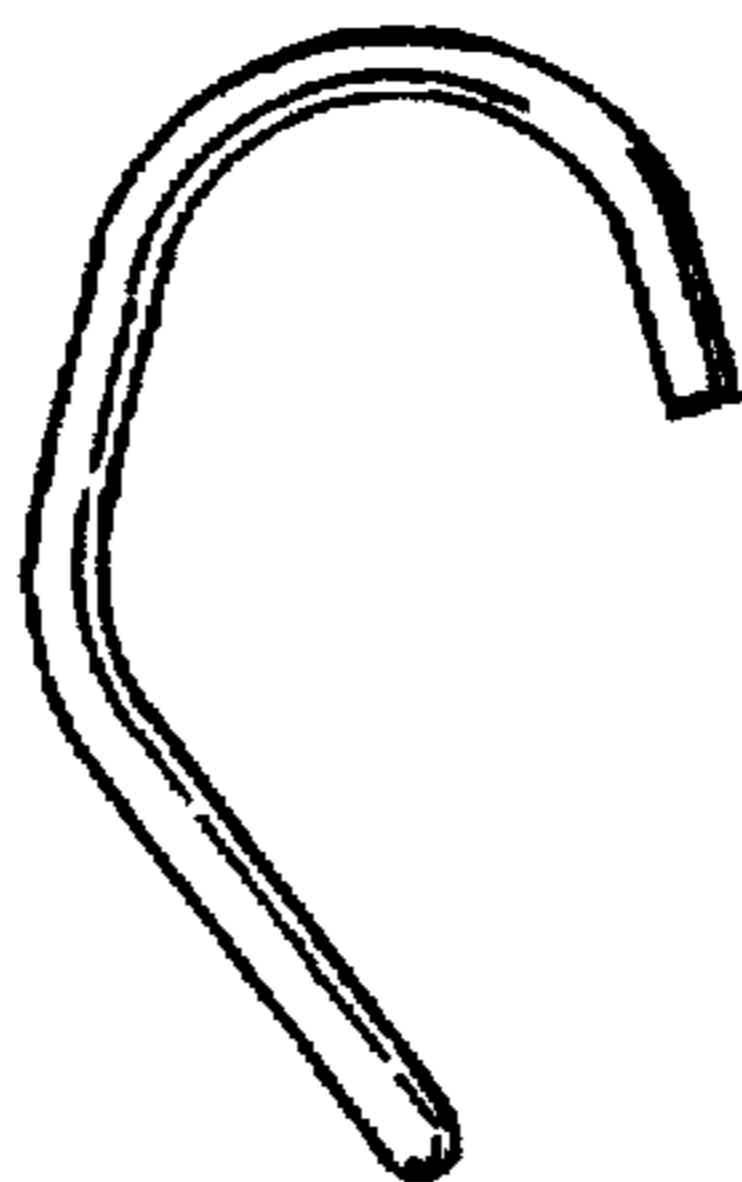

FIG. 5

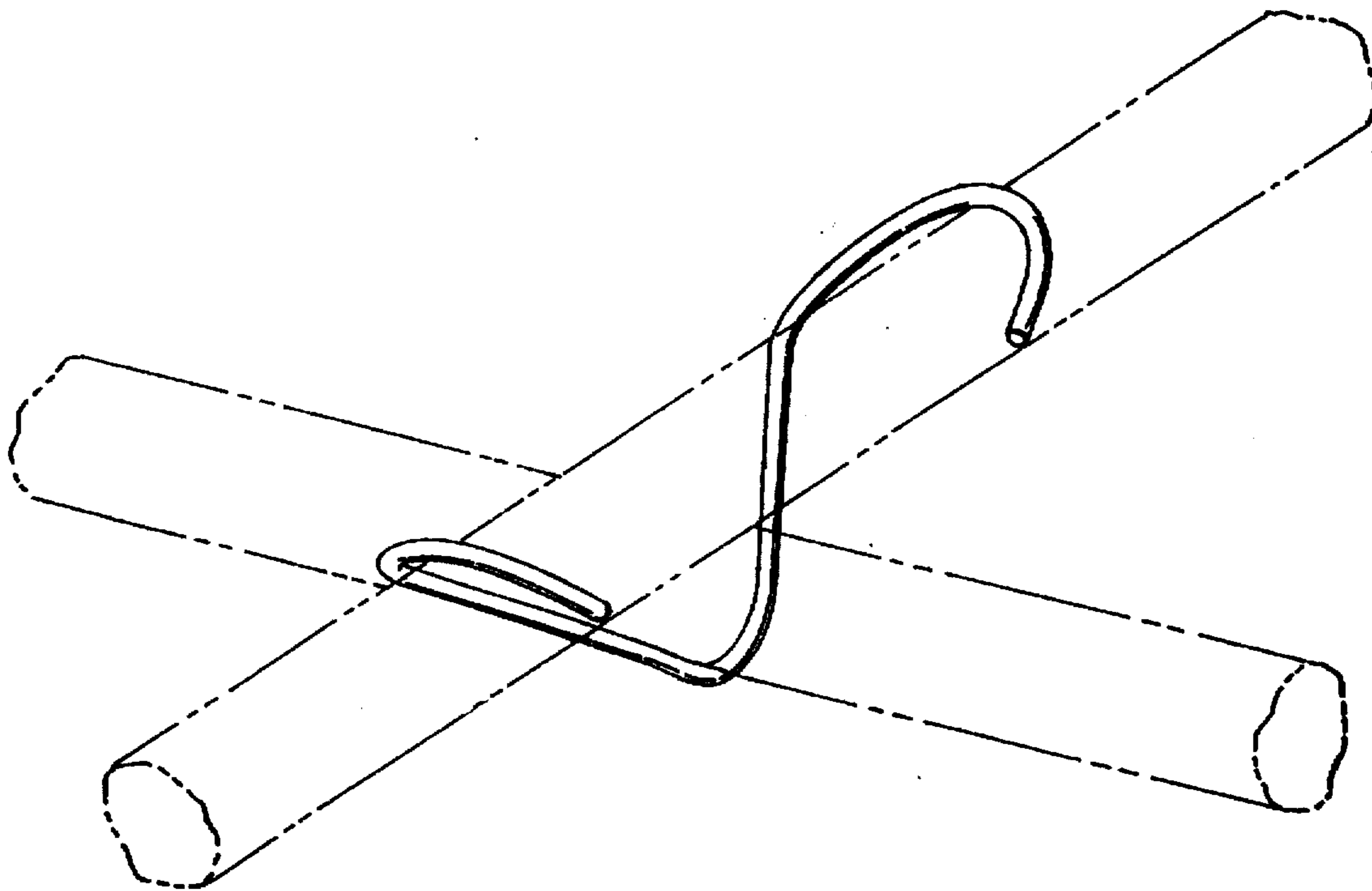

FIG. 6