



US00D388996S

United States Patent [19]
Bell

[11] **Patent Number:** **Des. 388,996**
[45] **Date of Patent:** ****Jan. 13, 1998**

[54] **ORTHOPEDIC PILLOW**

[76] **Inventor:** **Melvin C. Bell**, 10614 Sheldon Woods Way, Elk Grove, Calif. 95624

[**] **Term:** **14 Years**

[21] **Appl. No.:** **46,886**

[22] **Filed:** **Nov. 20, 1995**

[51] **LOC (6) Cl.** **06-09**

[52] **U.S. Cl.** **D6/601; D6/603**

[58] **Field of Search** **D6/368, 595, 596, D6/597, 601, 602, 603, 604, 605, 606, 607, 608, 609, 611, 616; 297/465, 452.23; 5/448, 645, 652-655, 636-638, 709**

[56] **References Cited**

U.S. PATENT DOCUMENTS

D. 258,035	1/1981	Fenwick	D6/603
D. 309,392	7/1990	Hafvenstein	D6/301
D. 341,979	12/1993	Peters	D6/596
D. 362,579	9/1995	Short	D6/601
1,409,746	3/1922	McCord	5/652
1,425,952	8/1922	Fidler	D6/603 X
5,152,018	10/1992	Lea	5/709 X
5,243,724	9/1993	Barnes	297/465 X

Primary Examiner—Martie Thompson

[57] **CLAIM**

The ornamental design for an orthopedic pillow, as shown and described.

DESCRIPTION

FIG. 1 is a left front perspective of the bottom of an orthopedic pillow, showing my new design;

FIG. 2 is a bottom plan view, thereof, showing an article pocket;

FIG. 3 is a top plan view, thereof;

FIG. 4 is a front elevational view, thereof;

FIG. 5 is a rear elevational view, thereof;

FIG. 6 is an elevational view, taken of the left hand side of the pillow;

FIG. 7 is an elevational view, taken of the right hand side of the pillow; and,

FIG. 8 is a front elevational view thereof, the chair and the magazine shown in the article pocket being depicted by means of broken lines for illustrative purposes only and forming no part of the claimed design.

The broken lines appearing in FIGS. 1 and 2 of the drawings are stitching.

1 Claim, 2 Drawing Sheets

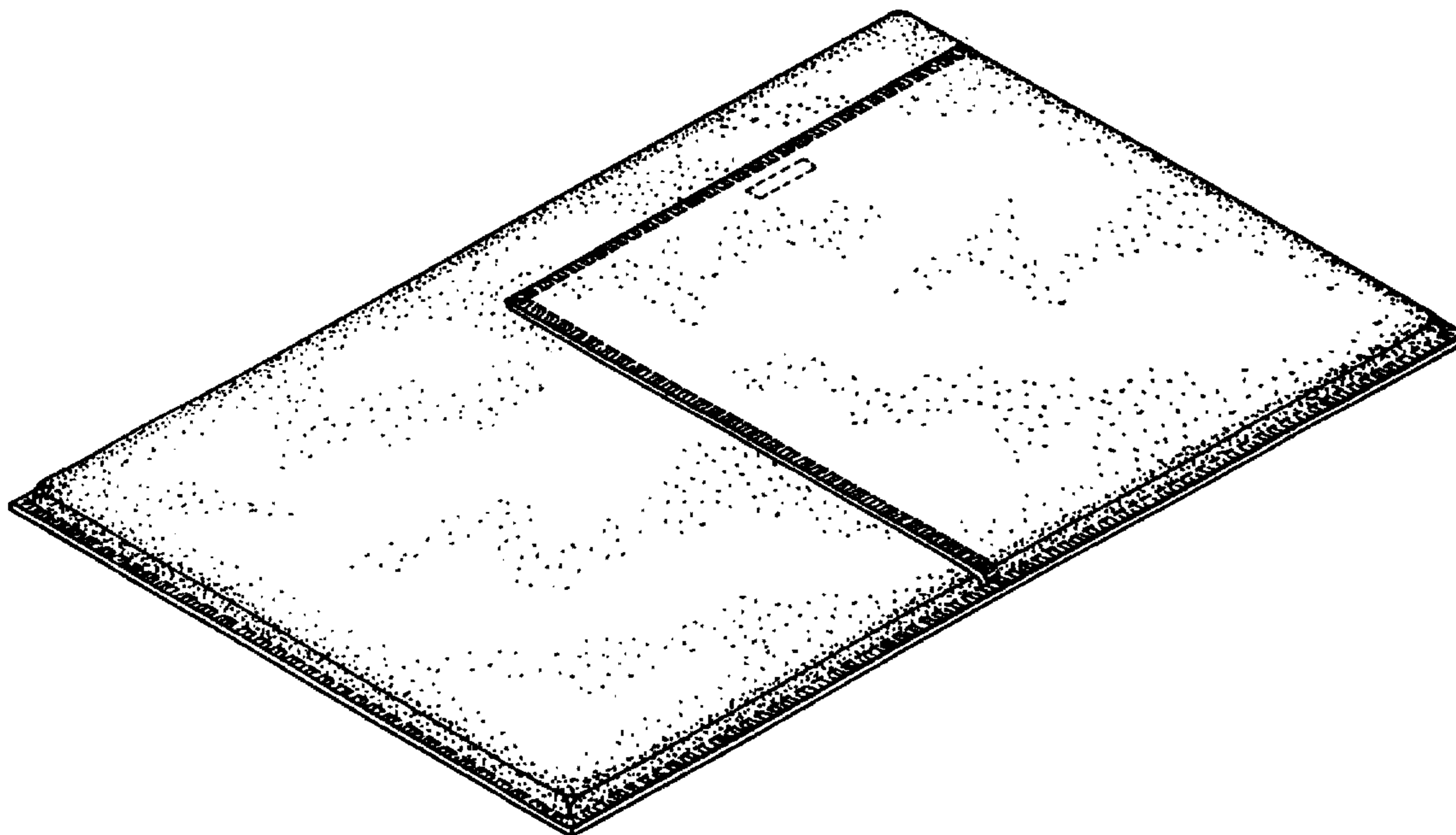

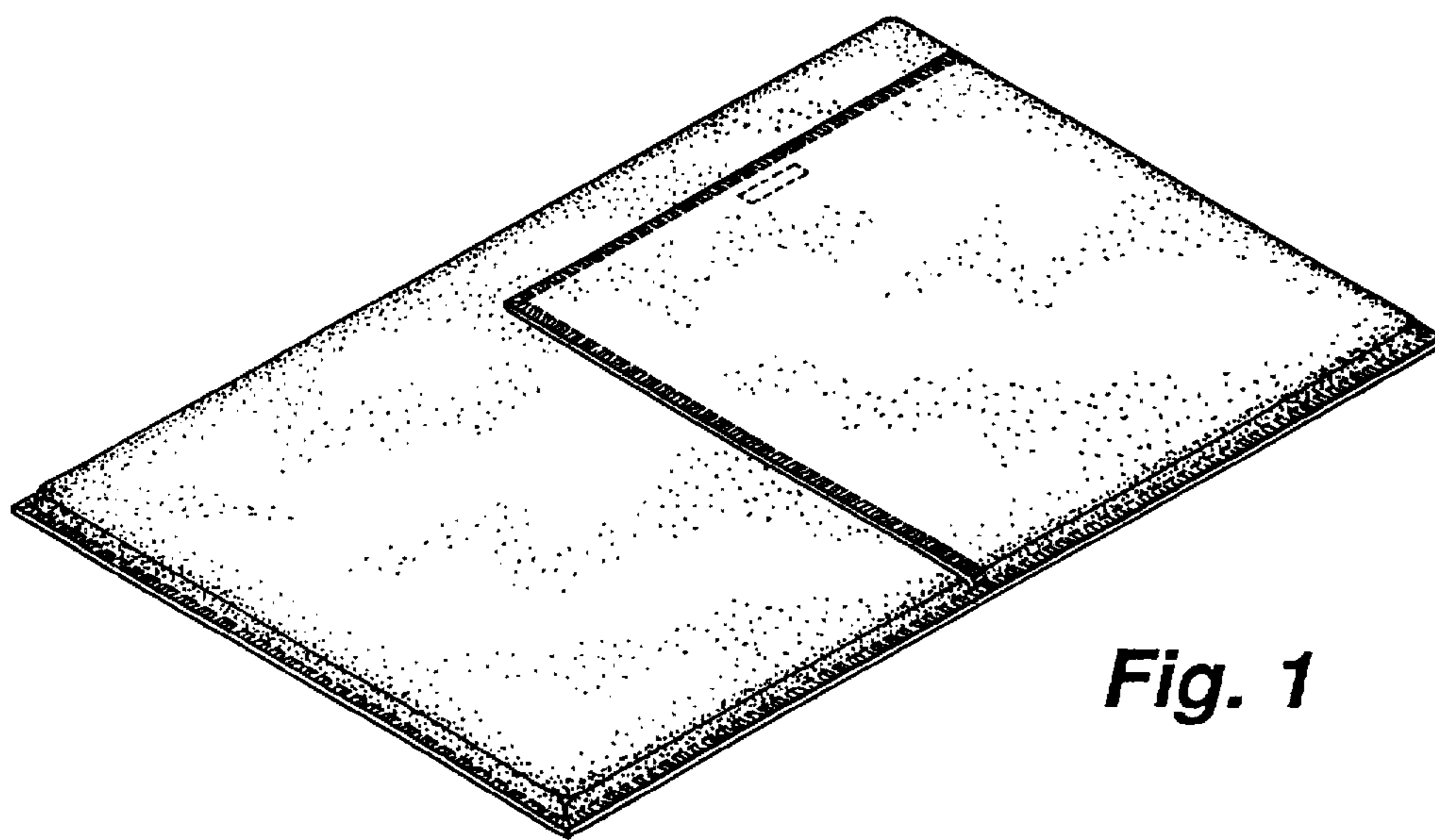

Fig. 1

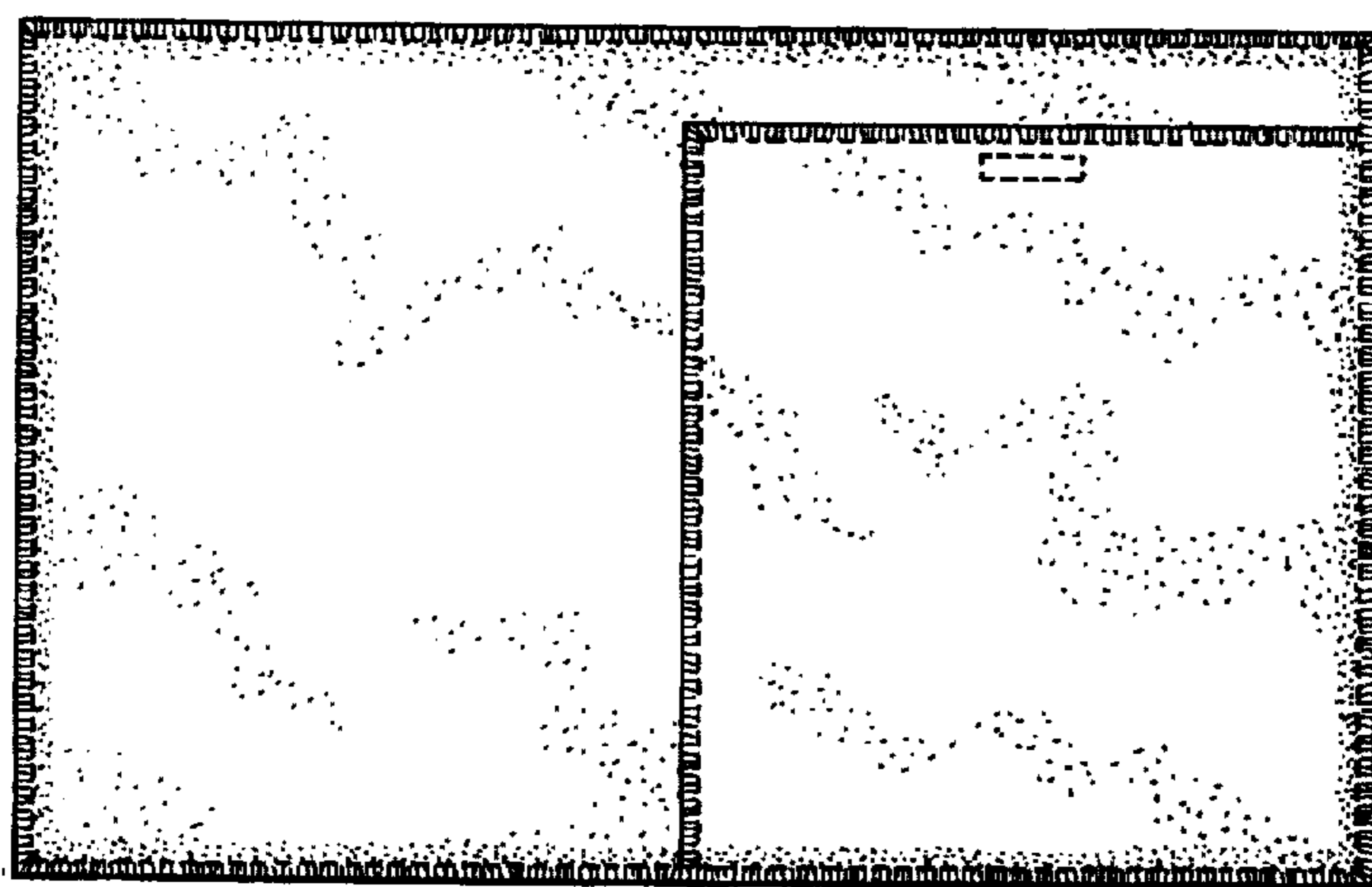

Fig. 2

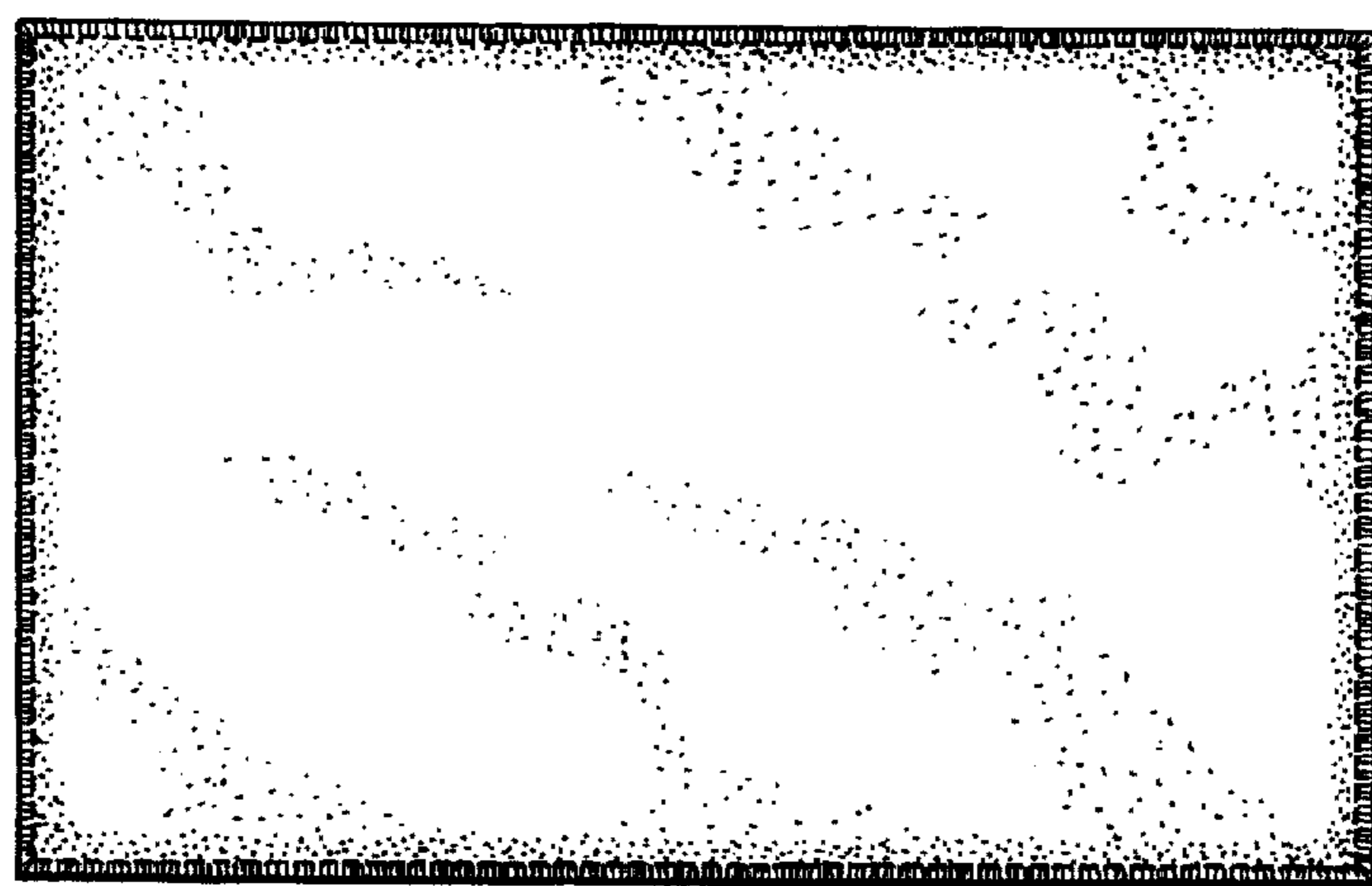

Fig. 3



Fig. 4



Fig. 5

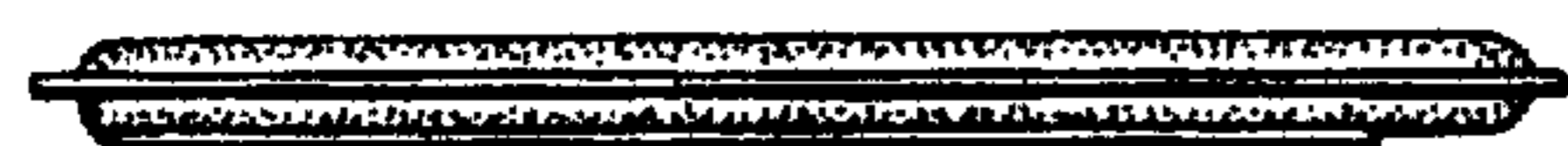

Fig. 6

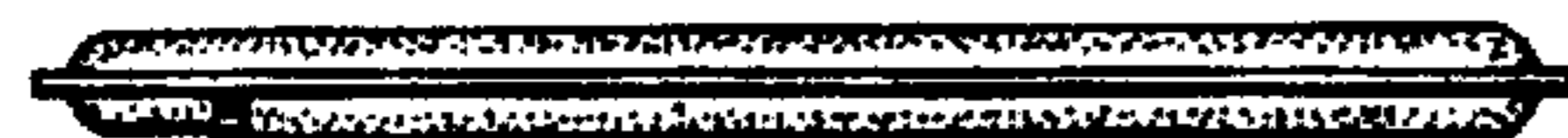

Fig. 7

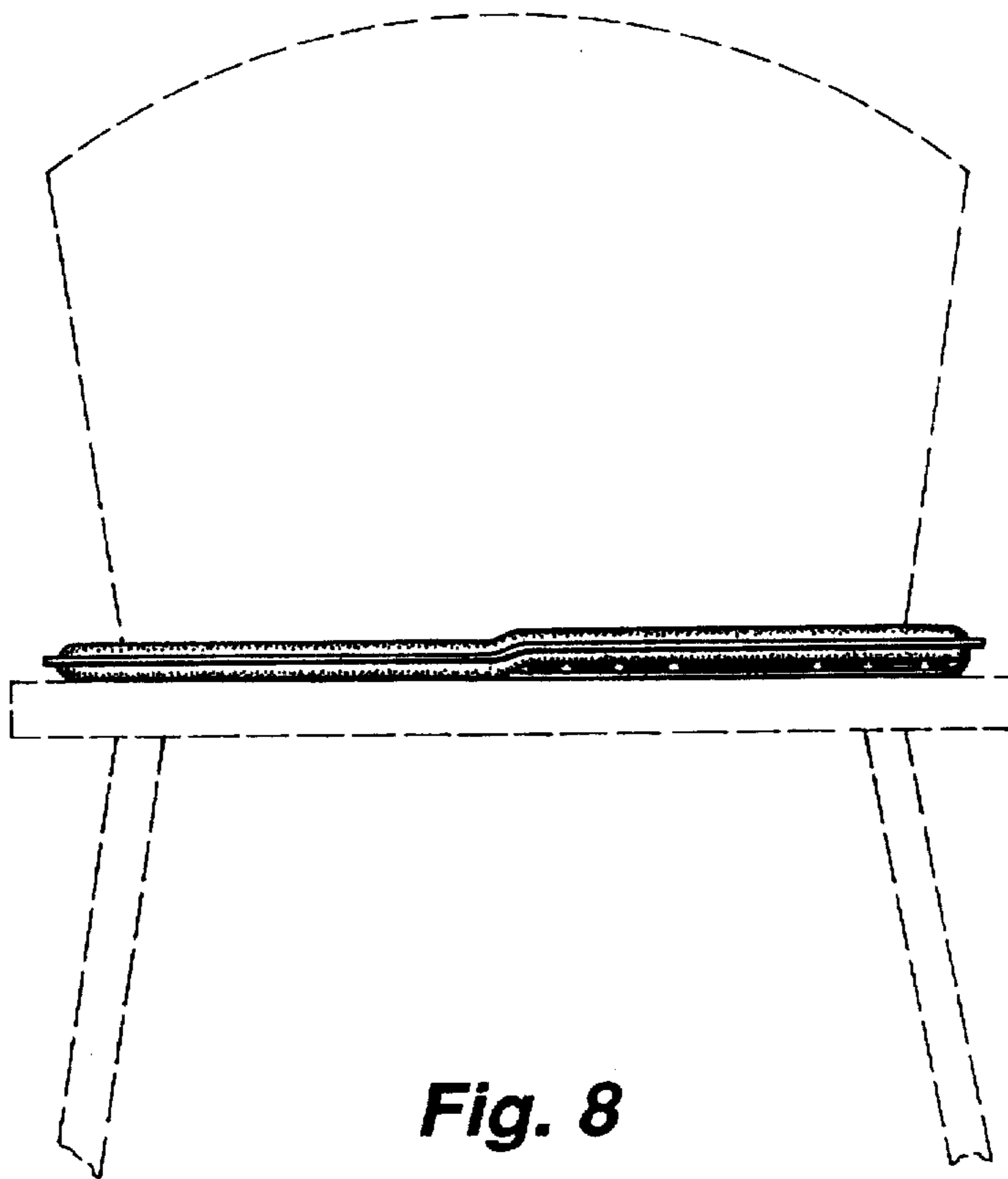

Fig. 8