

US00D388961S

# United States Patent [19] Berti

[11] Patent Number: **Des. 388,961**  
[45] Date of Patent: **\*\*Jan. 13, 1998**

- [54] **KITCHEN BRUSH HANDLE**
- [75] Inventor: **Enzo Berti**, Venice, Italy
- [73] Assignee: **The Libman Company**, Arcola, Ill.
- [\*\*] Term: **14 Years**
- [21] Appl. No.: **60,411**
- [22] Filed: **Sep. 27, 1996**
- [51] LOC (6) Cl. .... **04-01**
- [52] U.S. Cl. .... **D4/138; D4/127**
- [58] Field of Search ..... **D4/127, 129, 130, D4/132-134, 138; 15/143.1, 159.1, 160, 186, 187; D32/40, 51, 52**

[56] **References Cited**

**U.S. PATENT DOCUMENTS**

D. 110,363	7/1938	Racicot	.....	D4/132
D. 115,317	6/1939	Partridge	.....	D4/127
D. 119,028	2/1940	Partridge	.....	D4/132
D. 346,904	5/1994	Berti	.....	D4/138

*Primary Examiner*—Alan P. Douglas  
*Assistant Examiner*—Lavone D. Tabor  
*Attorney, Agent, or Firm*—Marshall, O'Toole, Gerstein, Murray & Borun

[57] **CLAIM**

The ornamental design for a kitchen brush handle, as shown and described.

**DESCRIPTION**

FIG. 1 is a perspective view;  
FIG. 2 is a right-side view, the left-side view being a mirror image thereof;  
FIG. 3 is a top view;  
FIG. 4 is a cross-section through lines 4—4 of FIG. 2;  
FIG. 5 is a cross-section through lines 5—5 of FIG. 2;  
FIG. 6 is a cross-section through lines 6—6 of FIG. 2;  
FIG. 7 is a bottom view;  
FIG. 8 is a front view; and,  
FIG. 9 is a back view.

The broken lines in FIG. 1 represent bristles, and form no part of the claimed design.

**1 Claim, 2 Drawing Sheets**

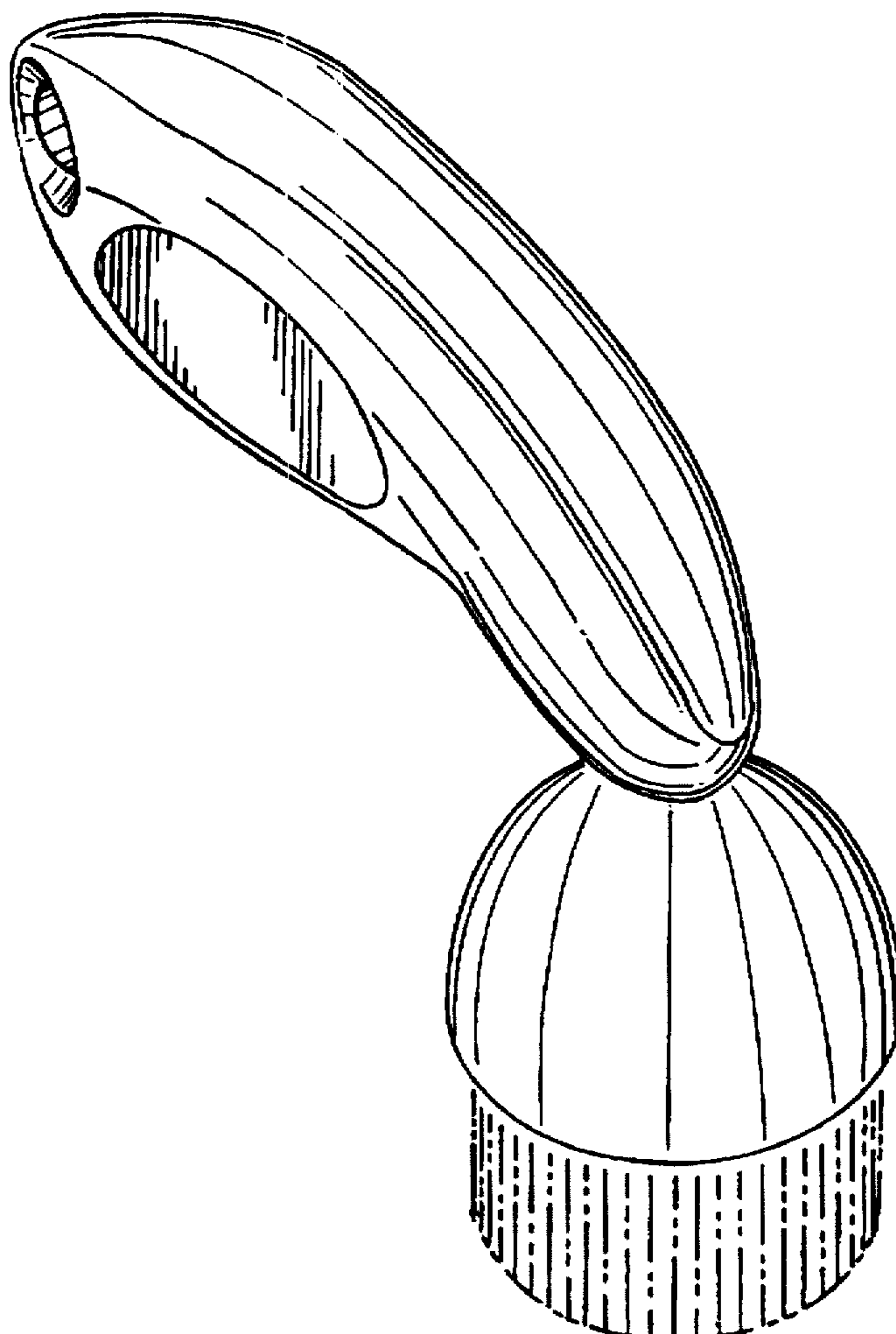

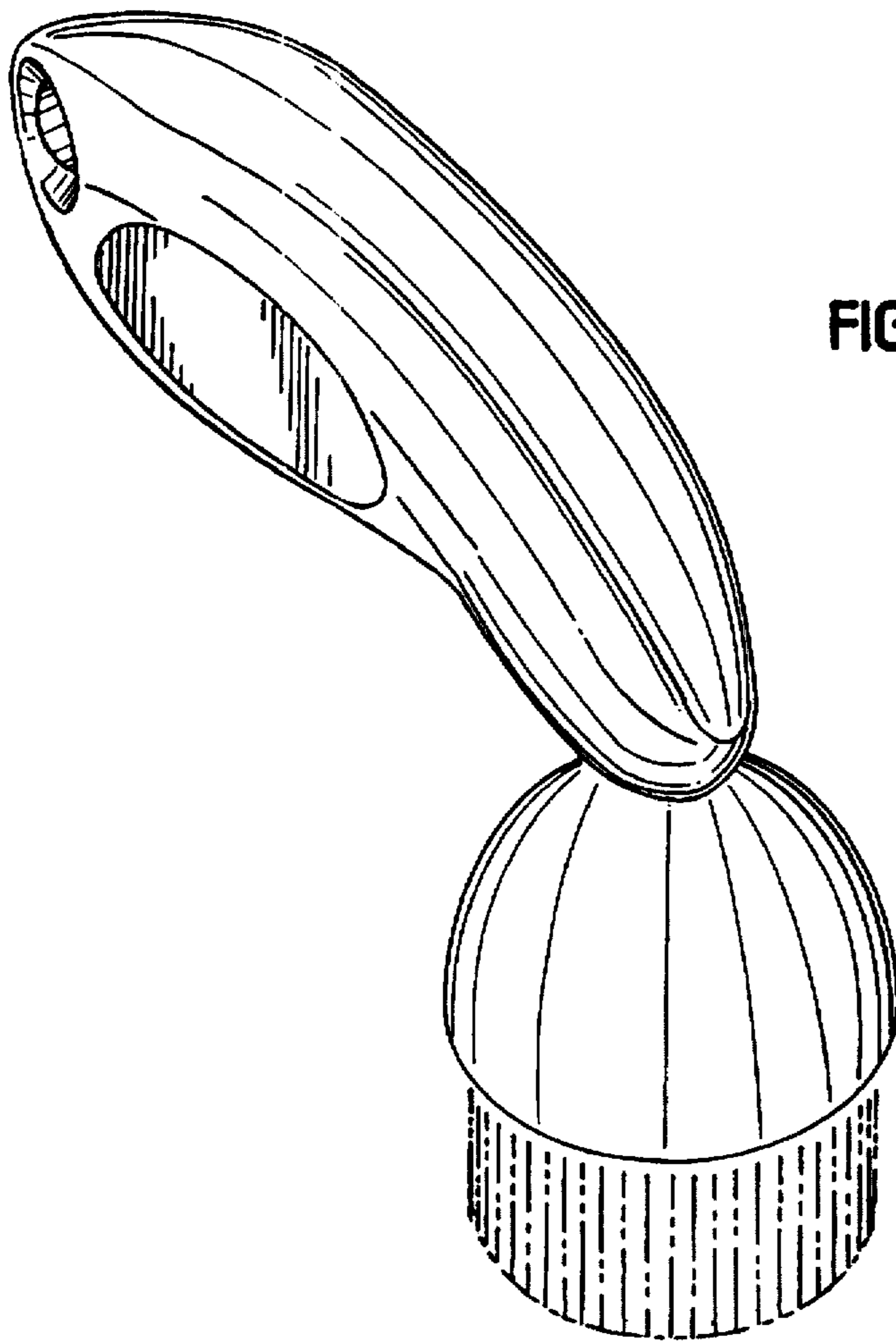

FIG. 1

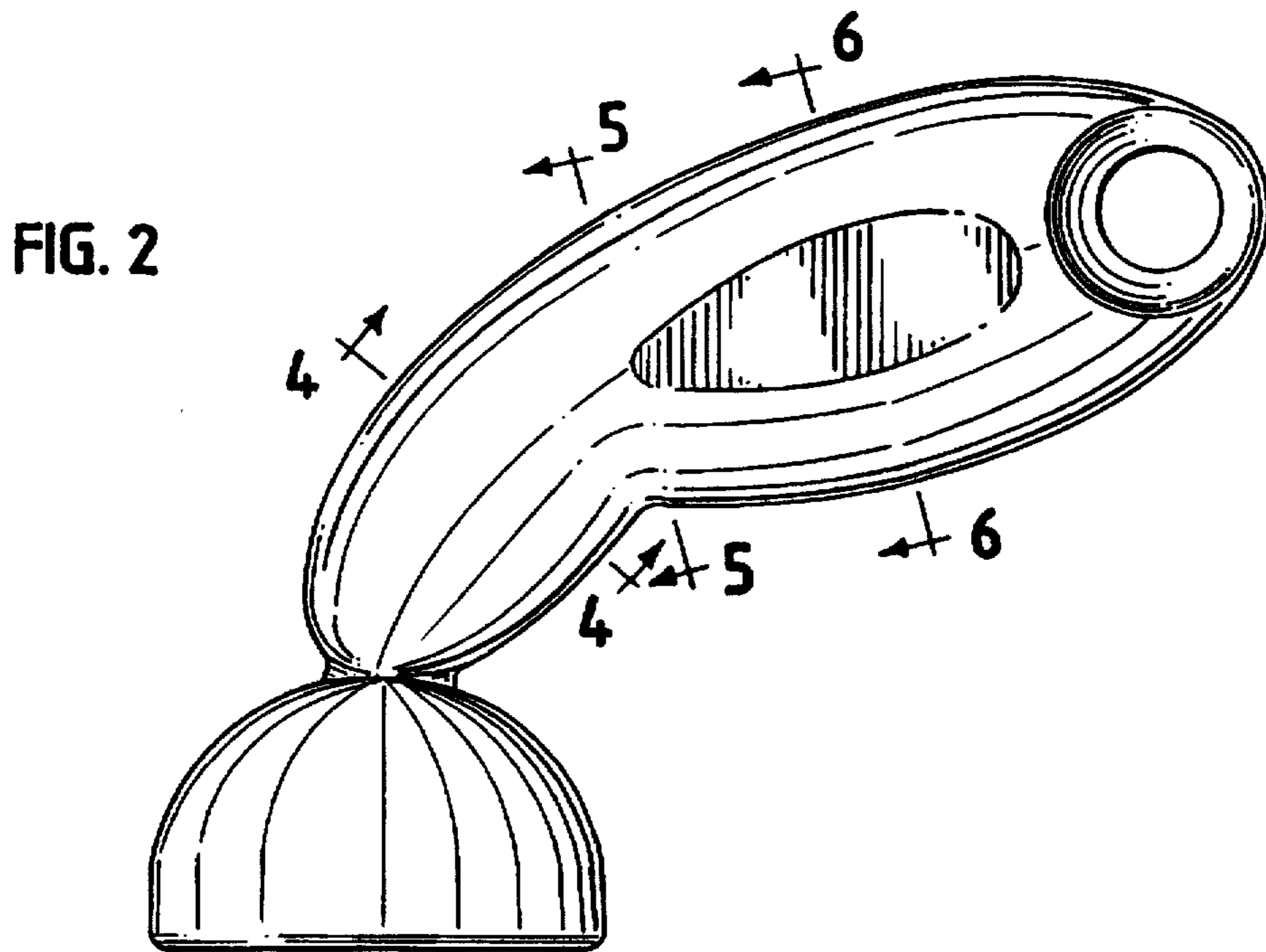

FIG. 2

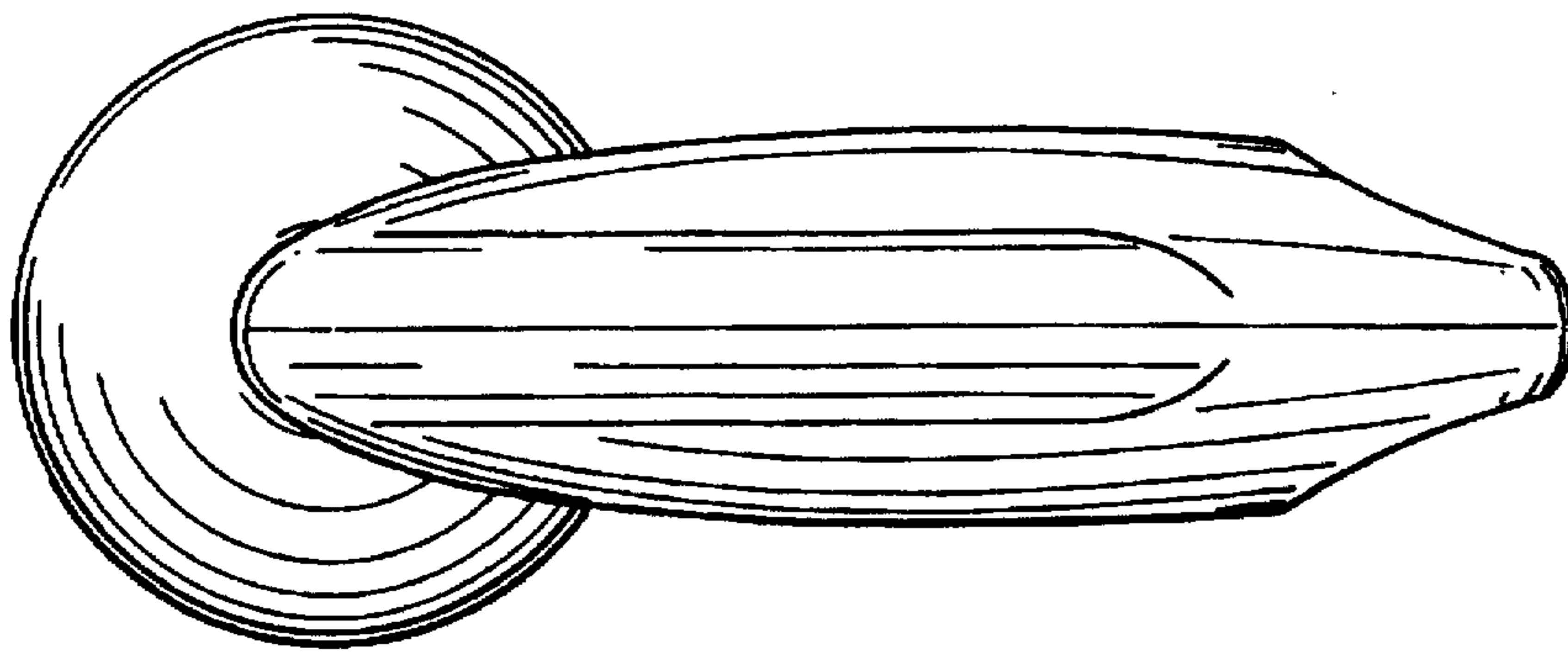

FIG. 3

FIG. 7

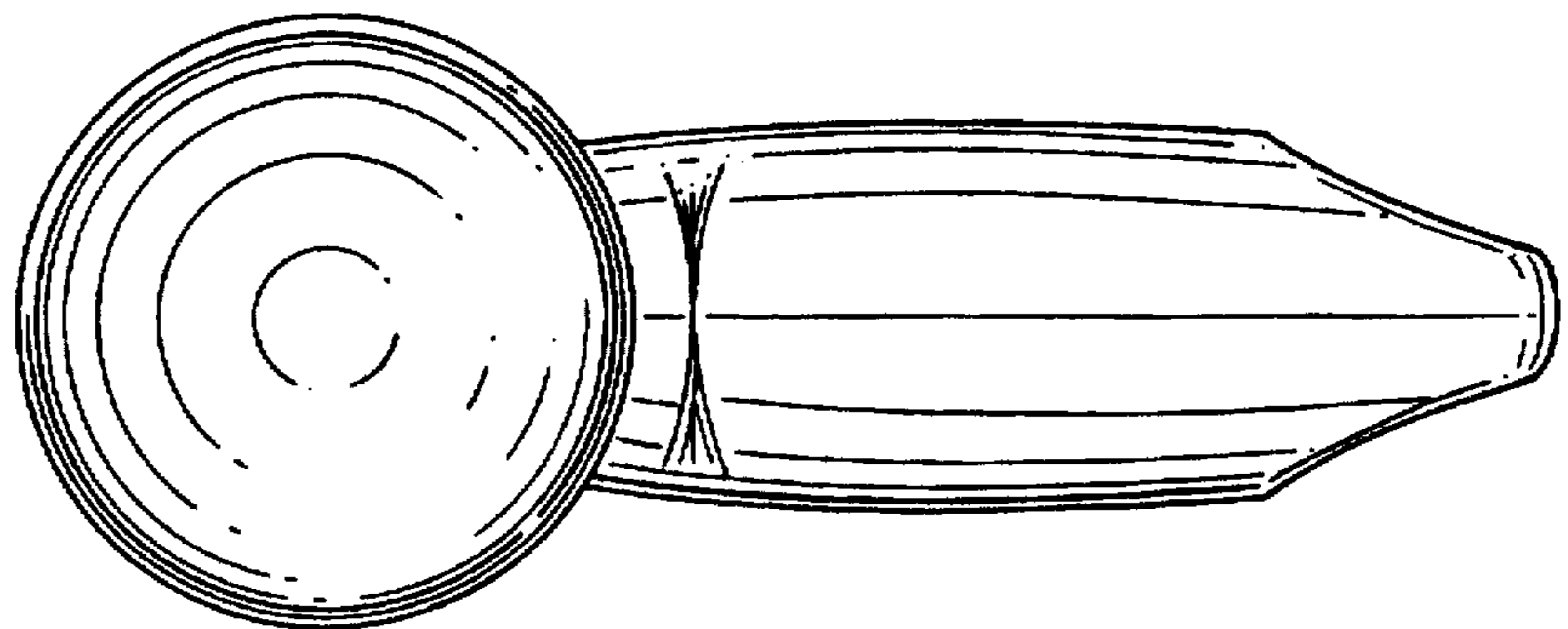

FIG. 4

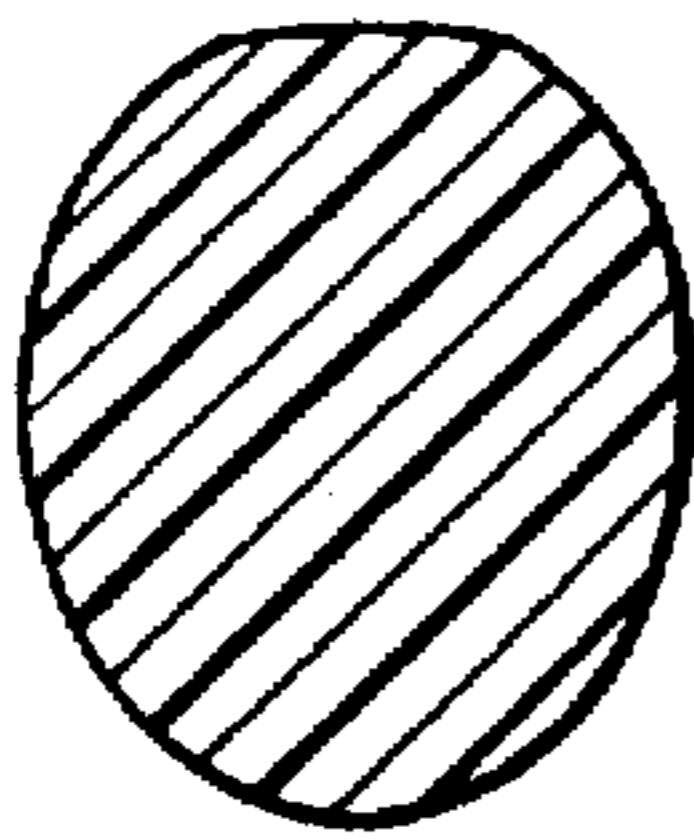

FIG. 5

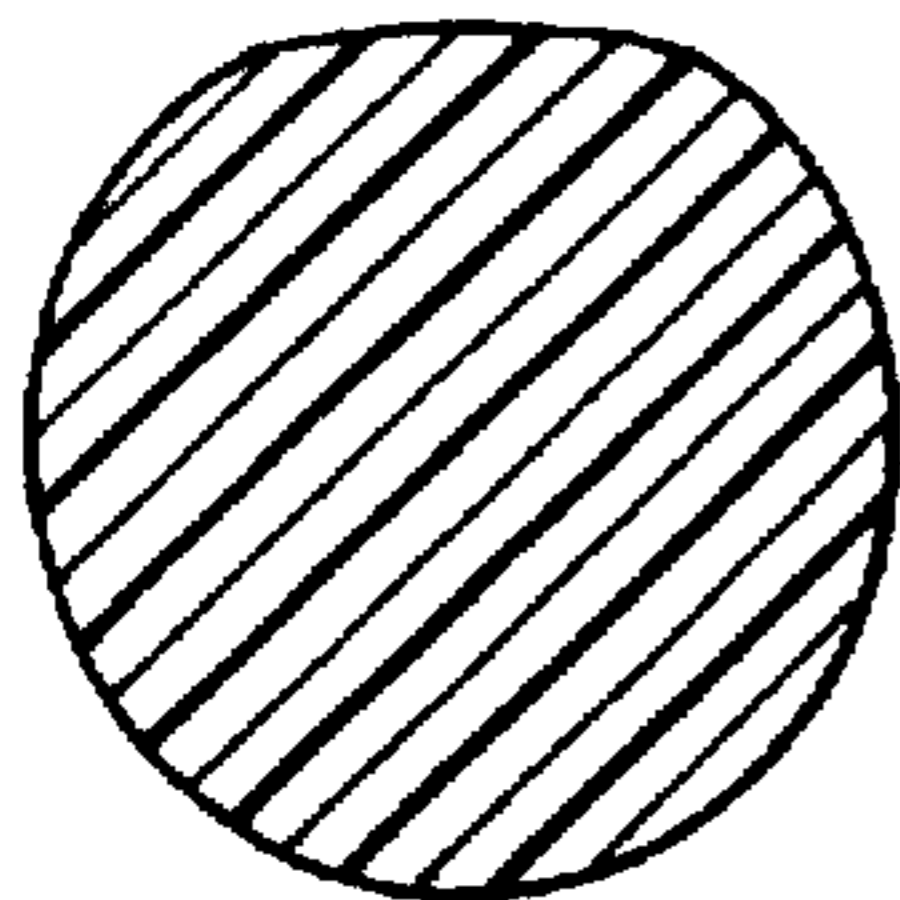

FIG. 6

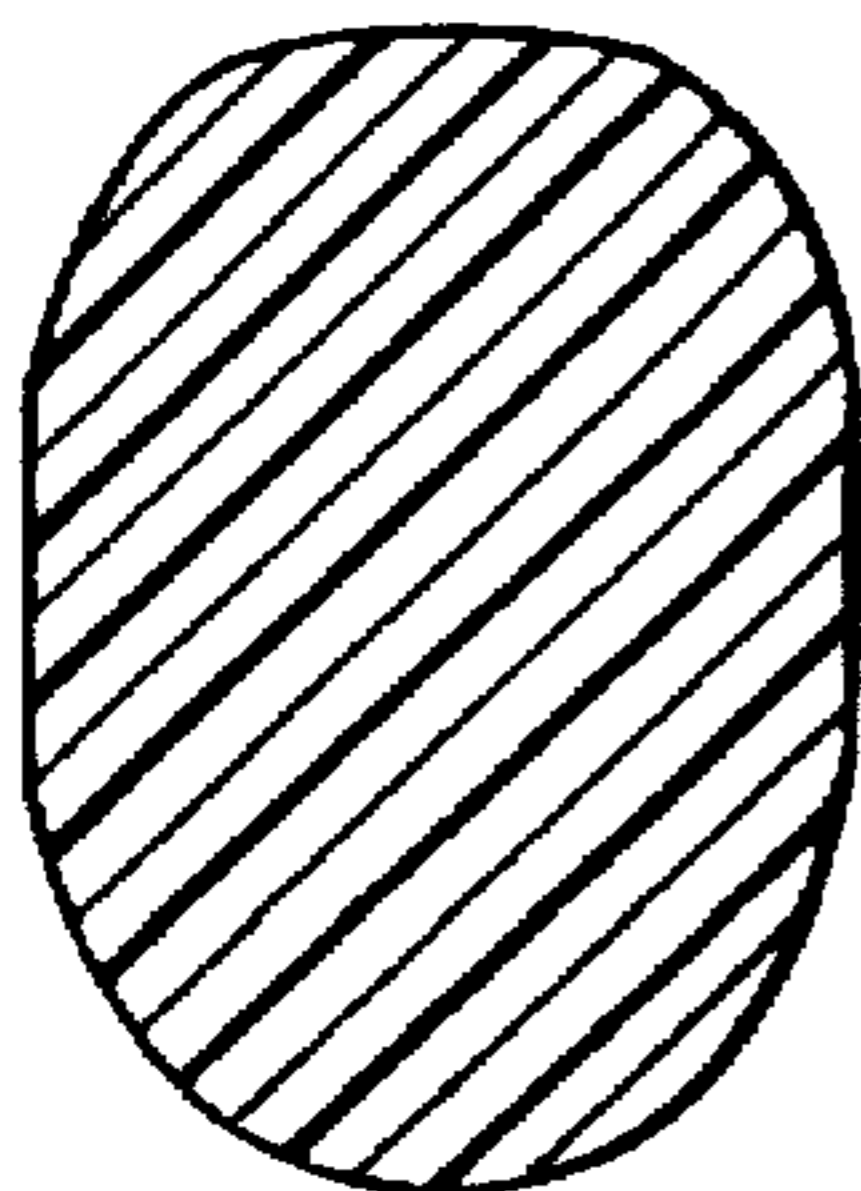

FIG. 8

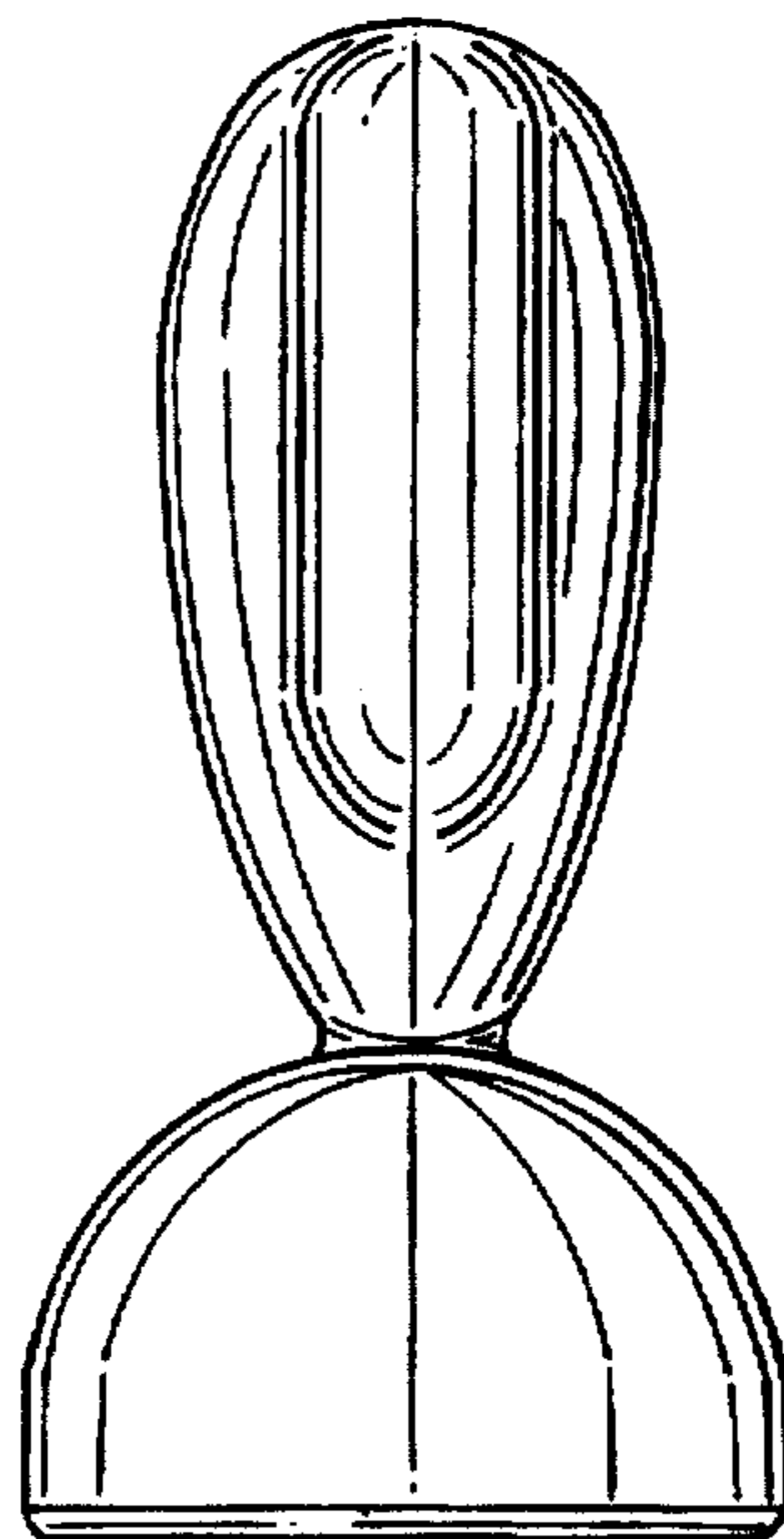

FIG. 9

