



US00D388761S

United States Patent [19]
Wilkinson

[11] **Patent Number:** **Des. 388,761**
[45] **Date of Patent:** ****Jan. 6, 1998**

[54] **PLEASURE BOAT**

D. 319,622 9/1991 Kotzebue D12/315
D. 324,845 3/1992 Kotzebue D12/315
D. 329,418 9/1992 Jackson D12/315

[75] **Inventor:** **Daniel J. Wilkinson**, Bradenton, Fla.

[73] **Assignee:** **Clearwater Vacation Concepts, Inc.**,
Palmetto, Fla.

Primary Examiner—Kay H. Chin
Attorney, Agent, or Firm—Oldham & Oldham Co., L.P.A.

[**] **Term:** **14 Years**

[57] **CLAIM**

[21] **Appl. No.:** **58,749**

The ornamental design for the "pleasure boat", as shown in the accompanying drawings.

[22] **Filed:** **Aug. 22, 1996**

DESCRIPTION

[51] **LOC (6) Cl.** **12-06**

FIG. 1 is a front elevational view of a new design of a pleasure boat;

[52] **U.S. Cl.** **D12/315; D12/300**

FIG. 2 is a left side elevational view with reference to FIG. 1, the right side elevational view being essentially a mirror image thereof;

[58] **Field of Search** **D12/300-318;**
114/56, 57, 61, 283, 343, 364

FIG. 3 is a rear view;

[56] **References Cited**

FIG. 4 is a top plan view; and,

U.S. PATENT DOCUMENTS

FIG. 5 is a bottom plan view.

D. 235,753 7/1975 Bremer D12/302
D. 244,841 6/1977 Nescher D12/312
D. 319,619 9/1991 Kotzebue D12/315

1 Claim, 3 Drawing Sheets

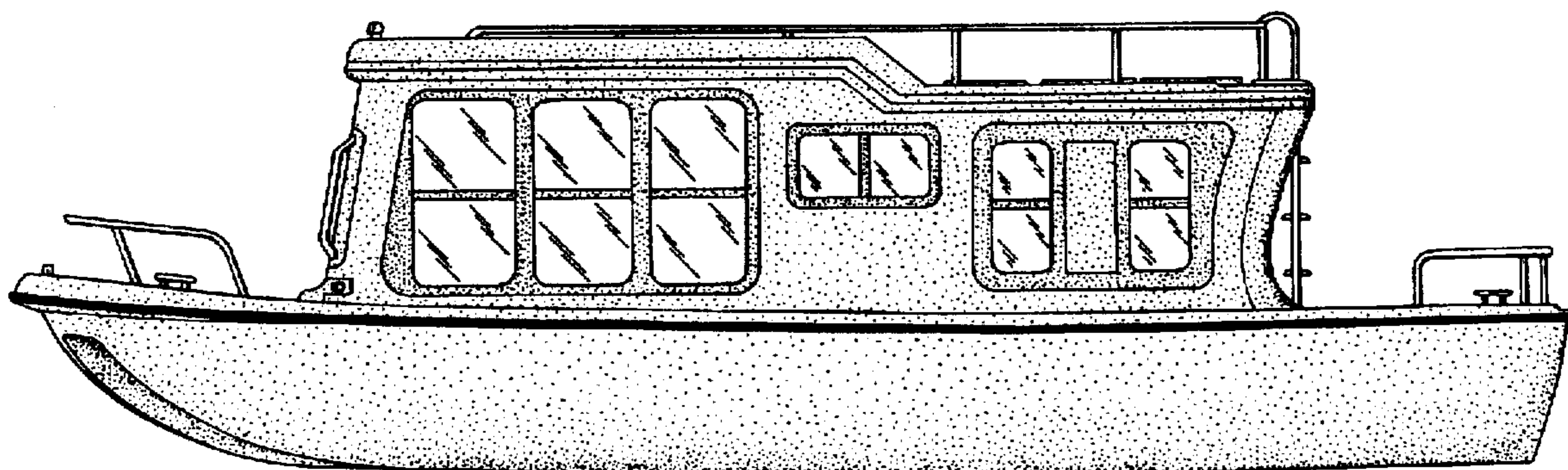
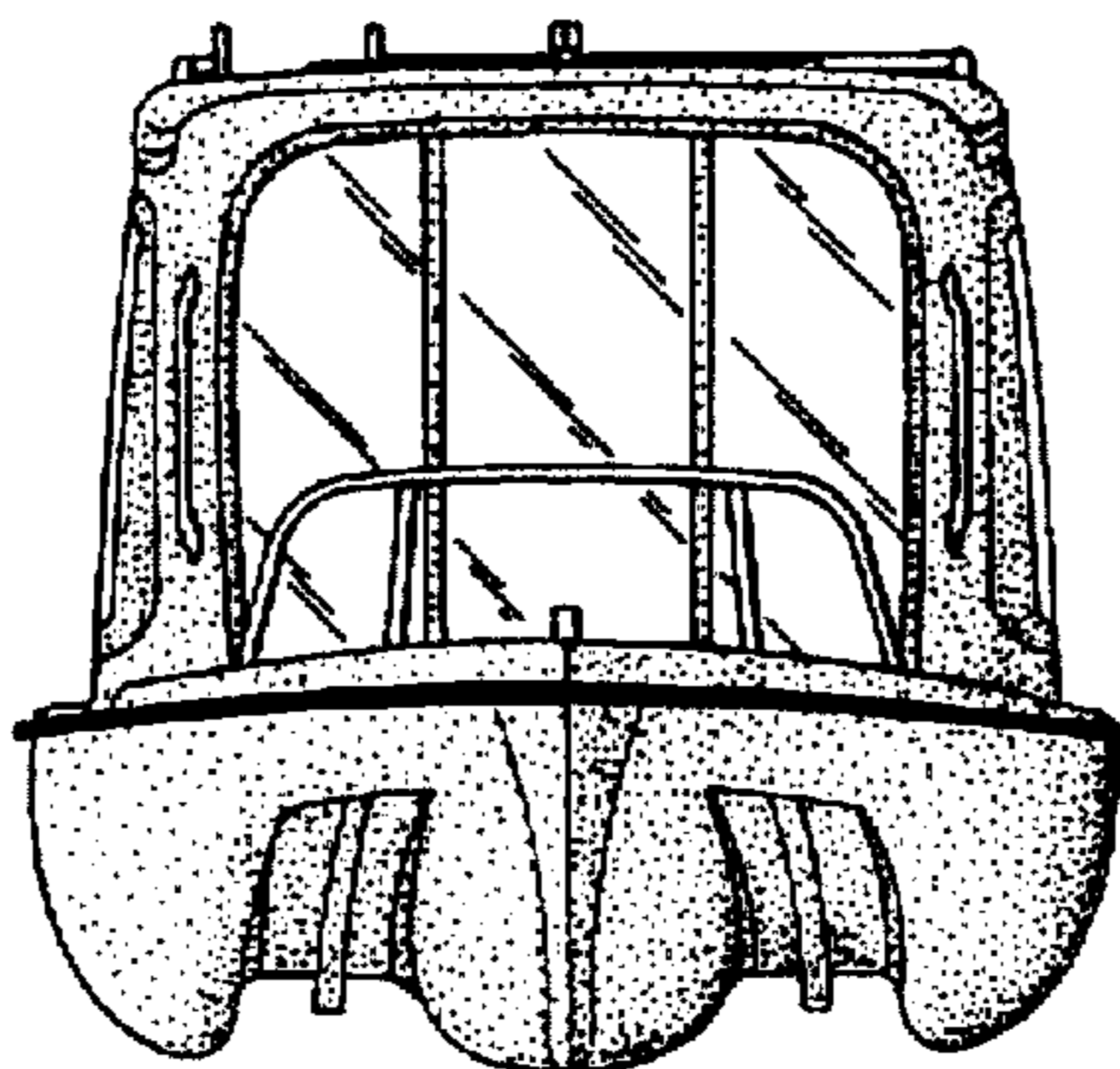

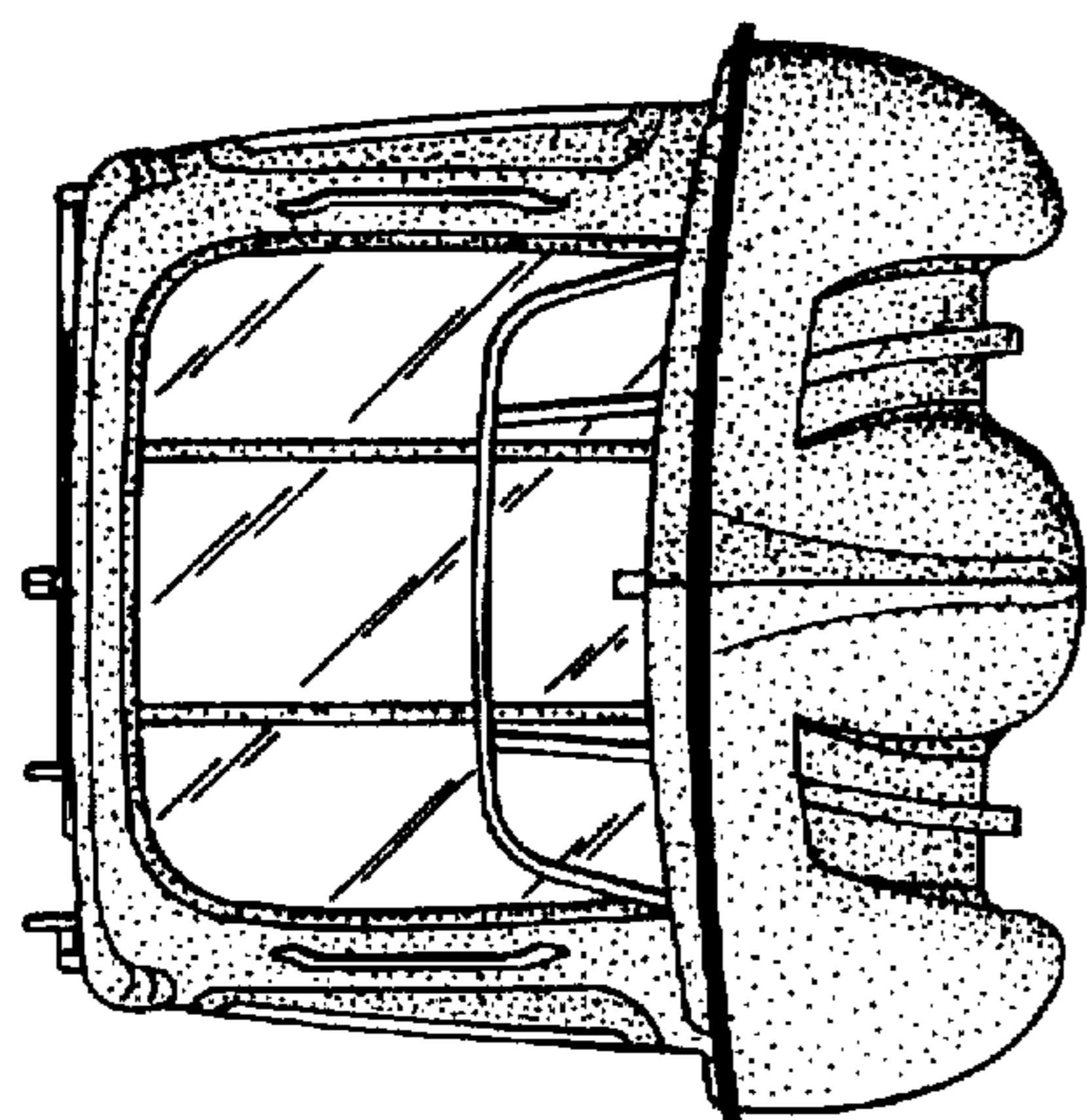

FIG. - 1

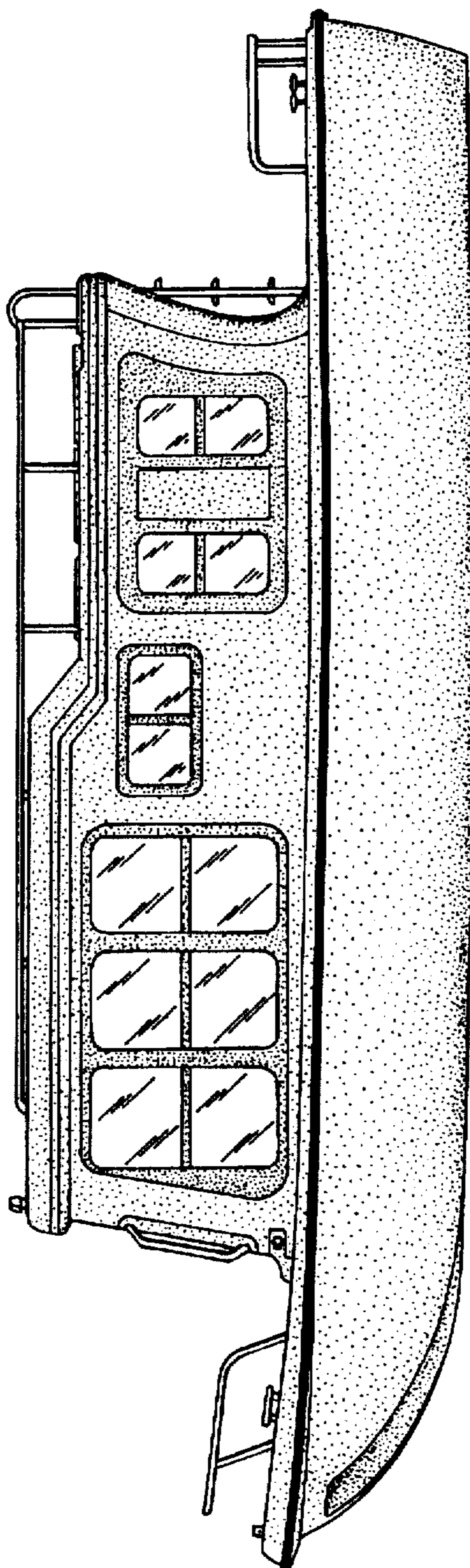

FIG. - 2

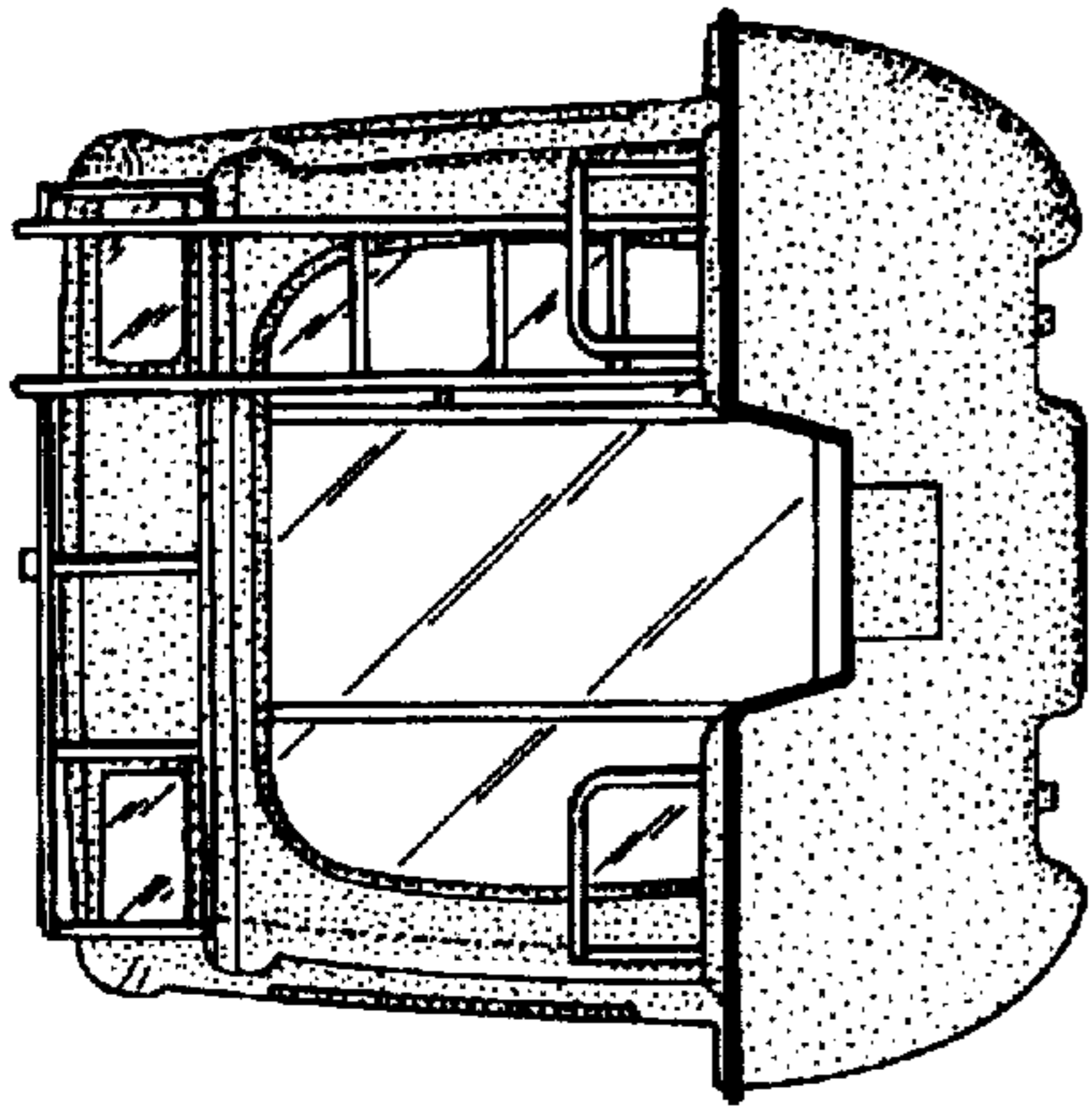

FIG. - 3

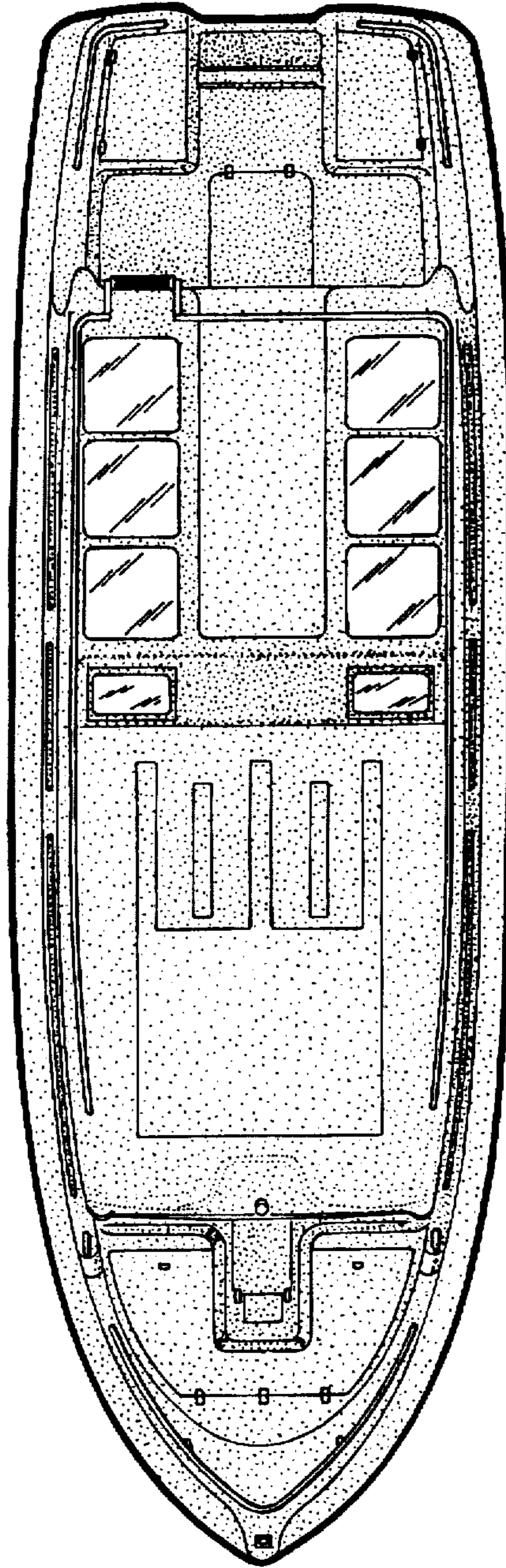

FIG. - 4

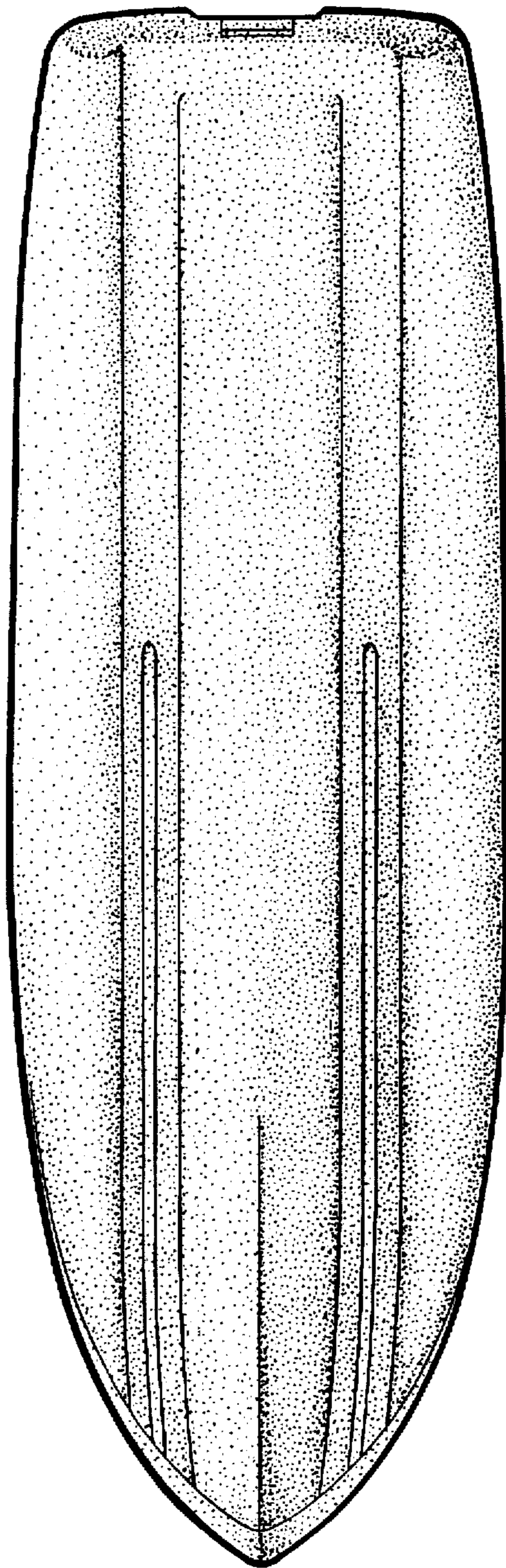

FIG. - 5