



US00D388748S

United States Patent [19]
Jackson

[11] **Patent Number:** **Des. 388,748**
[45] **Date of Patent:** ****Jan. 6, 1998**

[54] **BABY STROLLER**

[76] **Inventor:** **Jeffrey S. Jackson**, 22707 W.
Copperhill Dr., Unit #27, Saugus, Calif.
91350

[**] **Term:** **14 Years**

[21] **Appl. No.:** **53,448**

[22] **Filed:** **Apr. 22, 1996**

Related U.S. Application Data

[63] Continuation-in-part of Ser. No. 46,897, Nov. 20, 1995.

[51] **LOC (6) Cl.** **12-12**

[52] **U.S. Cl.** **D12/129; D21/76**

[58] **Field of Search** **D12/128, 129;**
280/650, 642, 643, 644, 647, 658; D21/76

[56] **References Cited**

U.S. PATENT DOCUMENTS

D. 293,227	12/1987	McElhaney	D12/129
1,482,146	1/1924	Pomilio	280/644
5,121,940	6/1992	March	280/30

Primary Examiner—Kay H. Chin
Attorney, Agent, or Firm—Ted Masters

[57] **CLAIM**

The ornamental design for a baby stroller, as shown and described.

DESCRIPTION

FIG. 1 is a perspective view showing my new design for a baby stroller;
 FIG. 2 is a side elevation view;
 FIG. 3 is an opposite side elevation view;
 FIG. 4 is a front elevation view;
 FIG. 5 is a rear elevation view;
 FIG. 6 is a top plan view;
 FIG. 7 is a bottom plan view;
 FIG. 8 is a view along the line 8—8 of FIG. 2;
 FIG. 9 is a perspective view of a second embodiment;
 FIG. 10 is a side elevation view of the second embodiment;
 FIG. 11 is an opposite side elevation view of the second embodiment;
 FIG. 12 is a front elevation view of the second embodiment;
 FIG. 13 is a rear elevation view of the second embodiment;
 FIG. 14 is a top plan view of the second embodiment;
 FIG. 15 is a bottom plan view of the second embodiment;
 and,
 FIG. 16 is a view along the line 16—16 of FIG. 10.

1 Claim, 14 Drawing Sheets

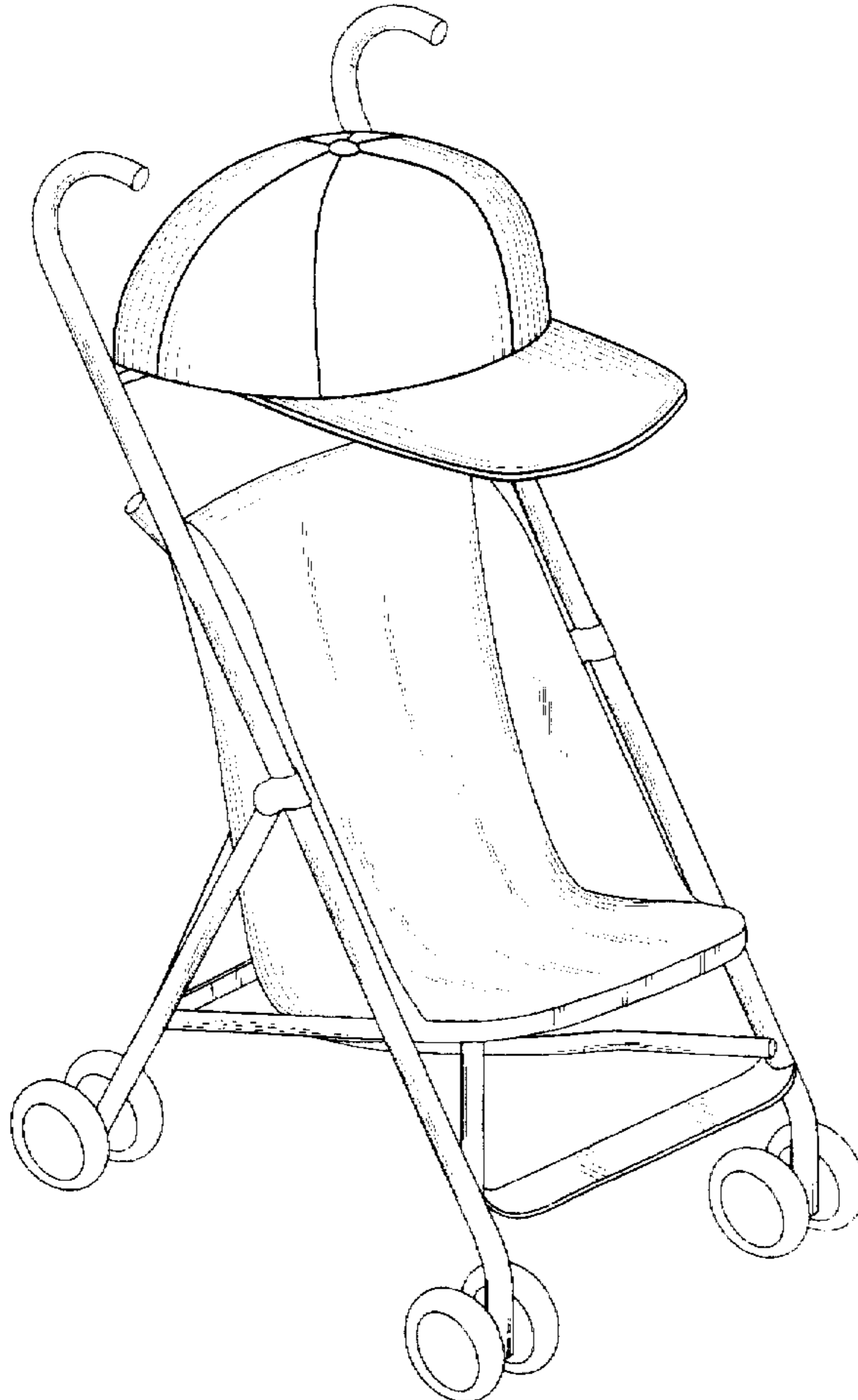

FIG. 1

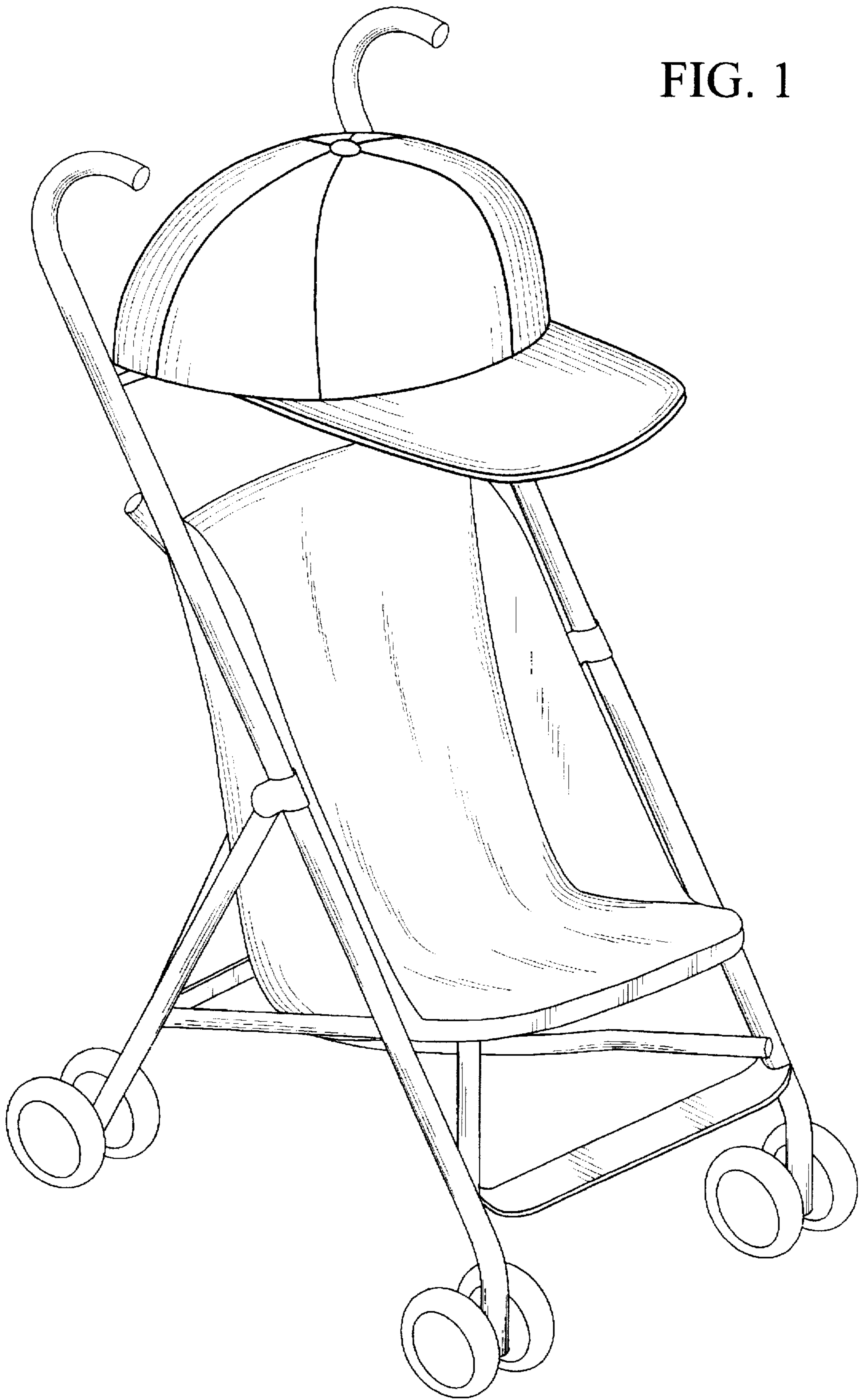

FIG. 2

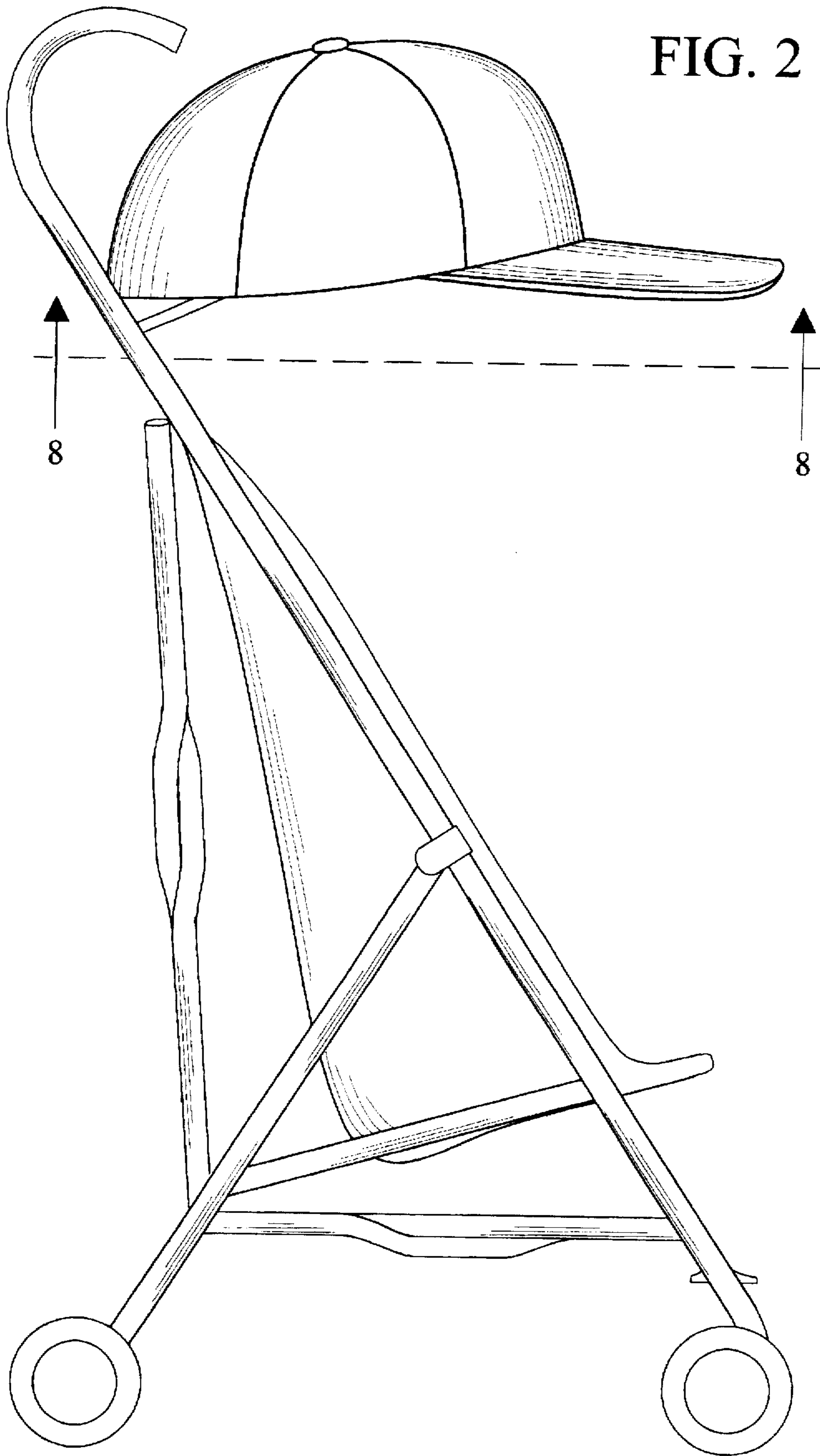
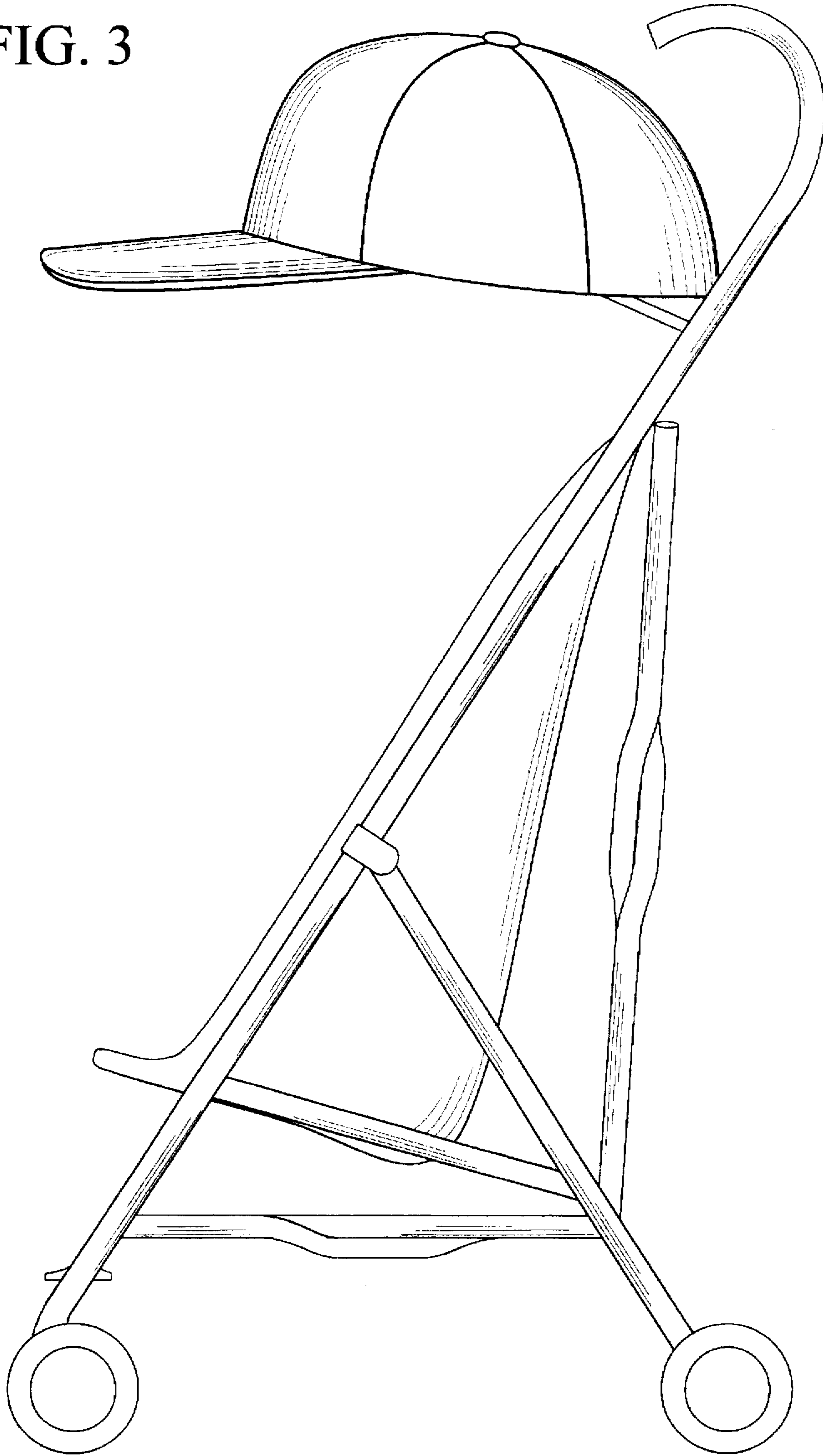

FIG. 3



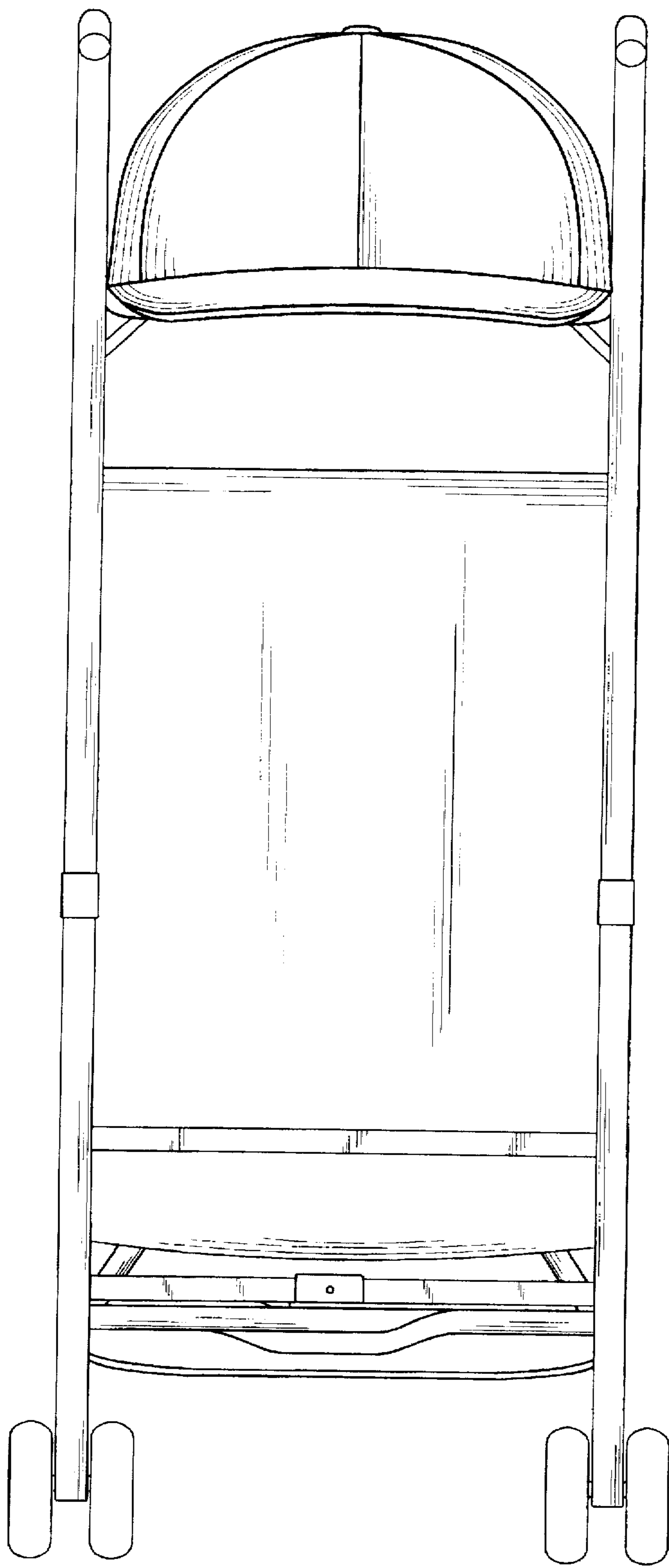

FIG. 4

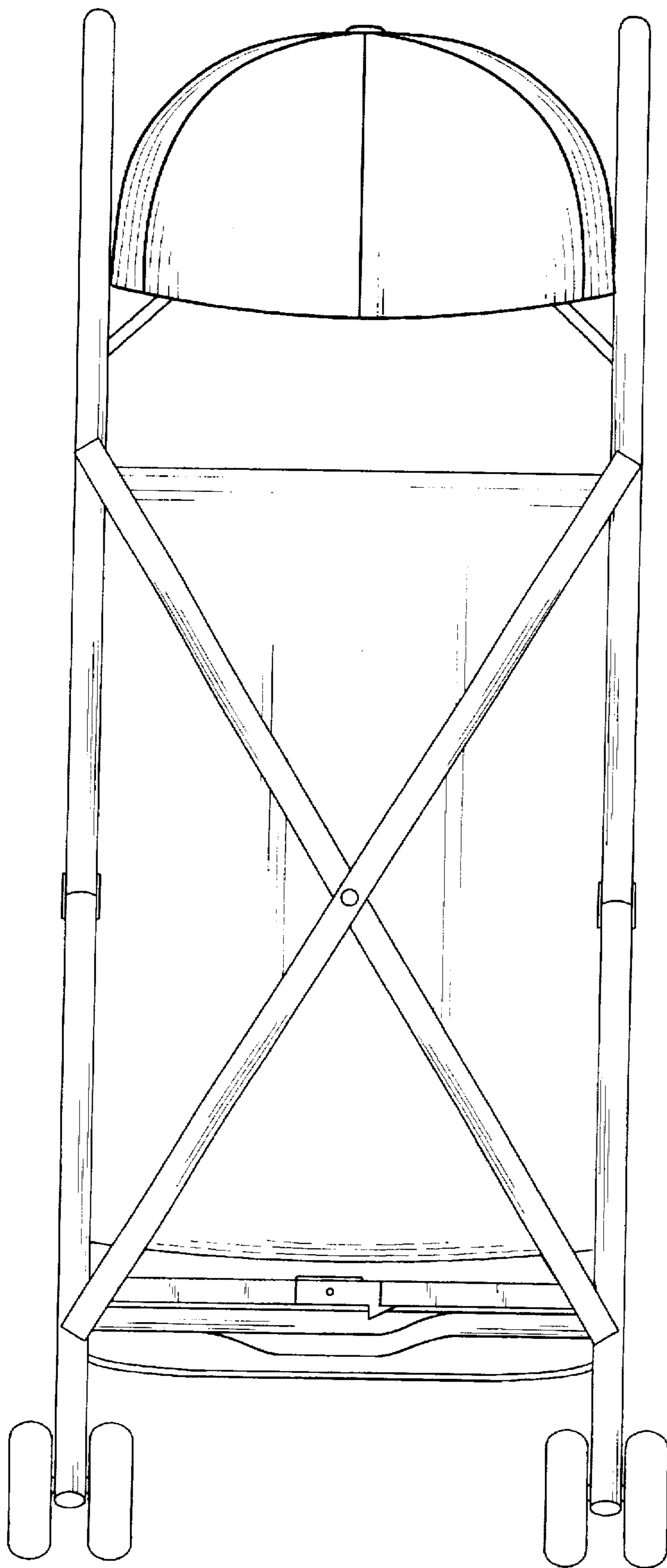

FIG. 5

FIG. 6

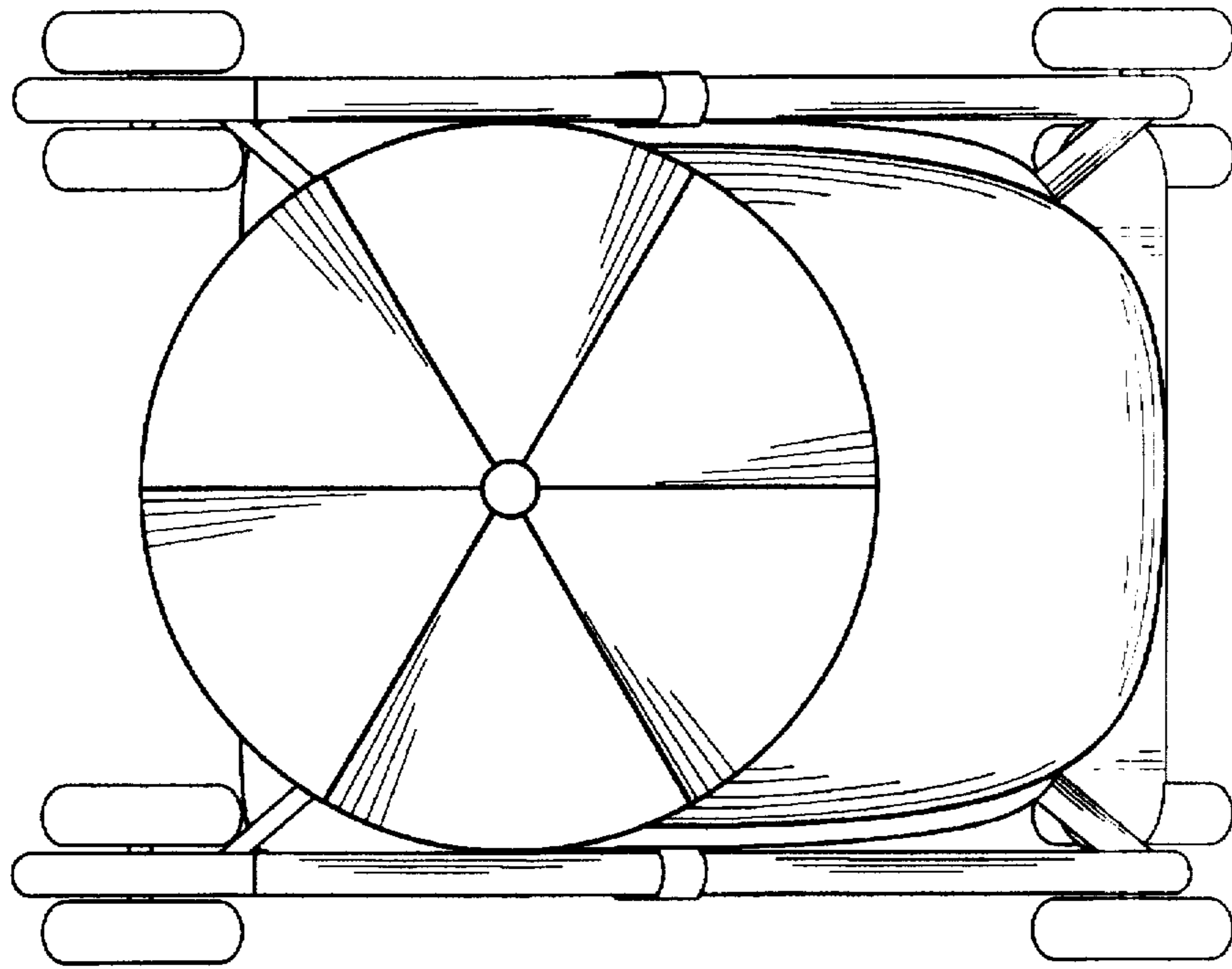

FIG. 7

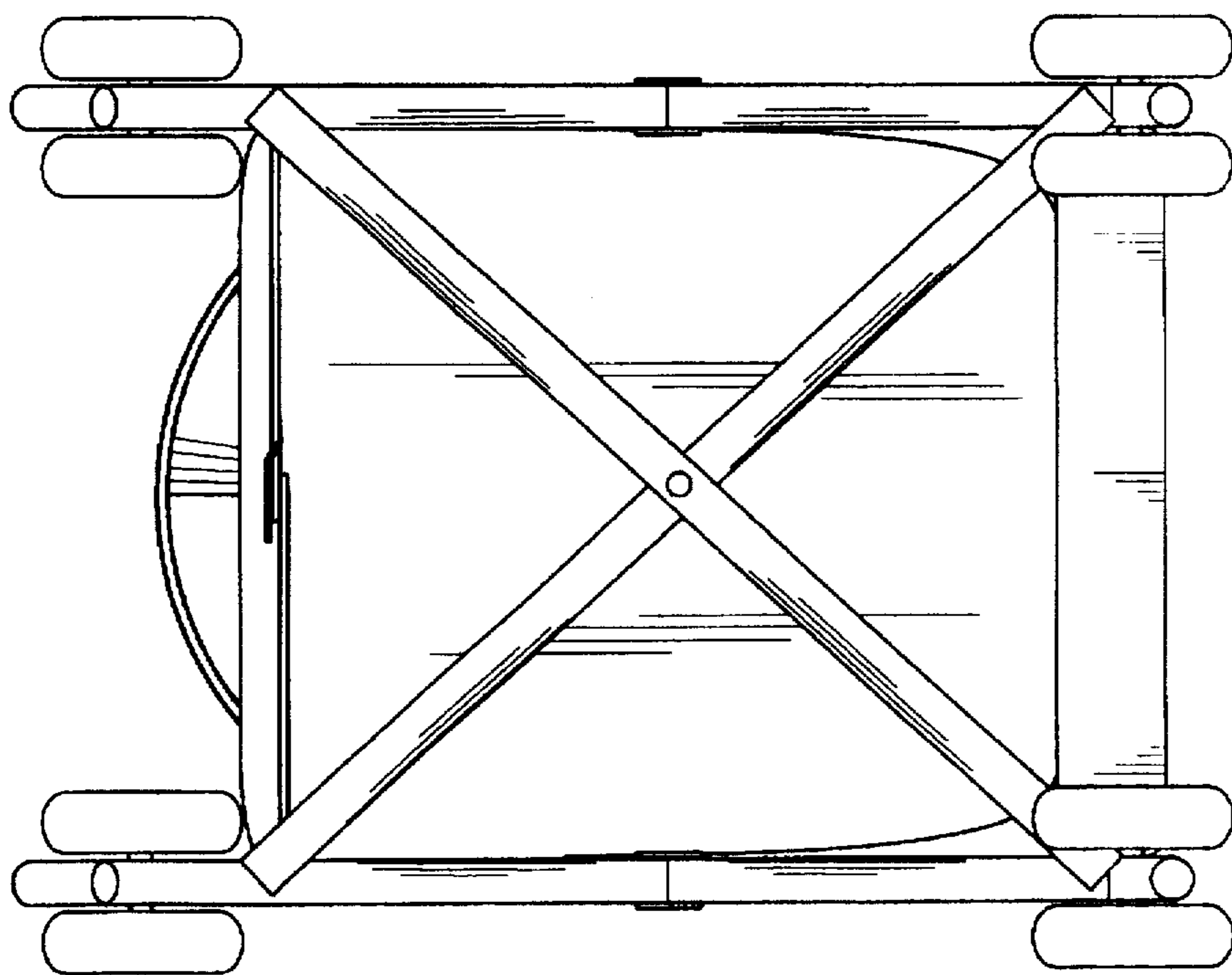

FIG. 8

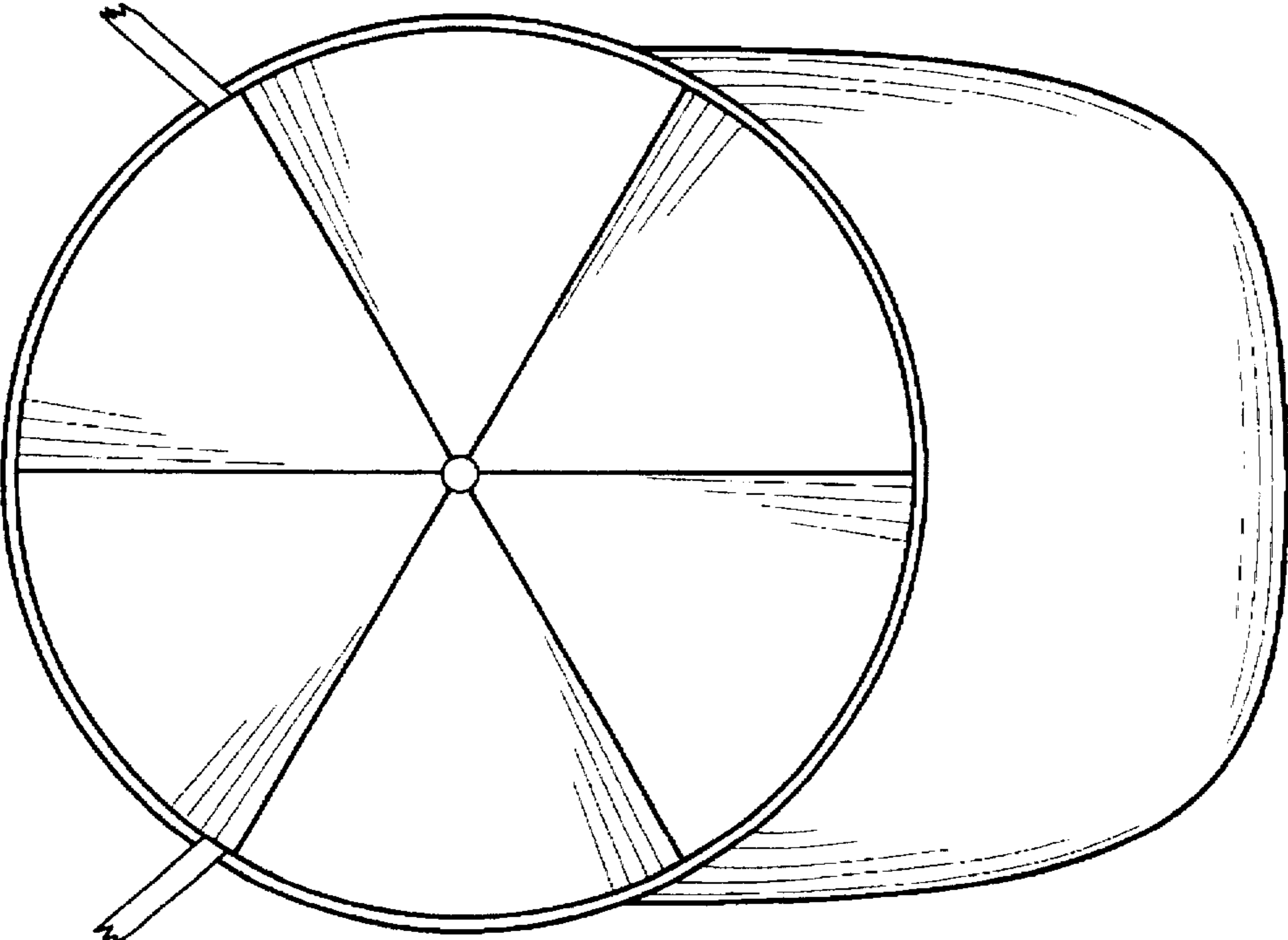

FIG. 9

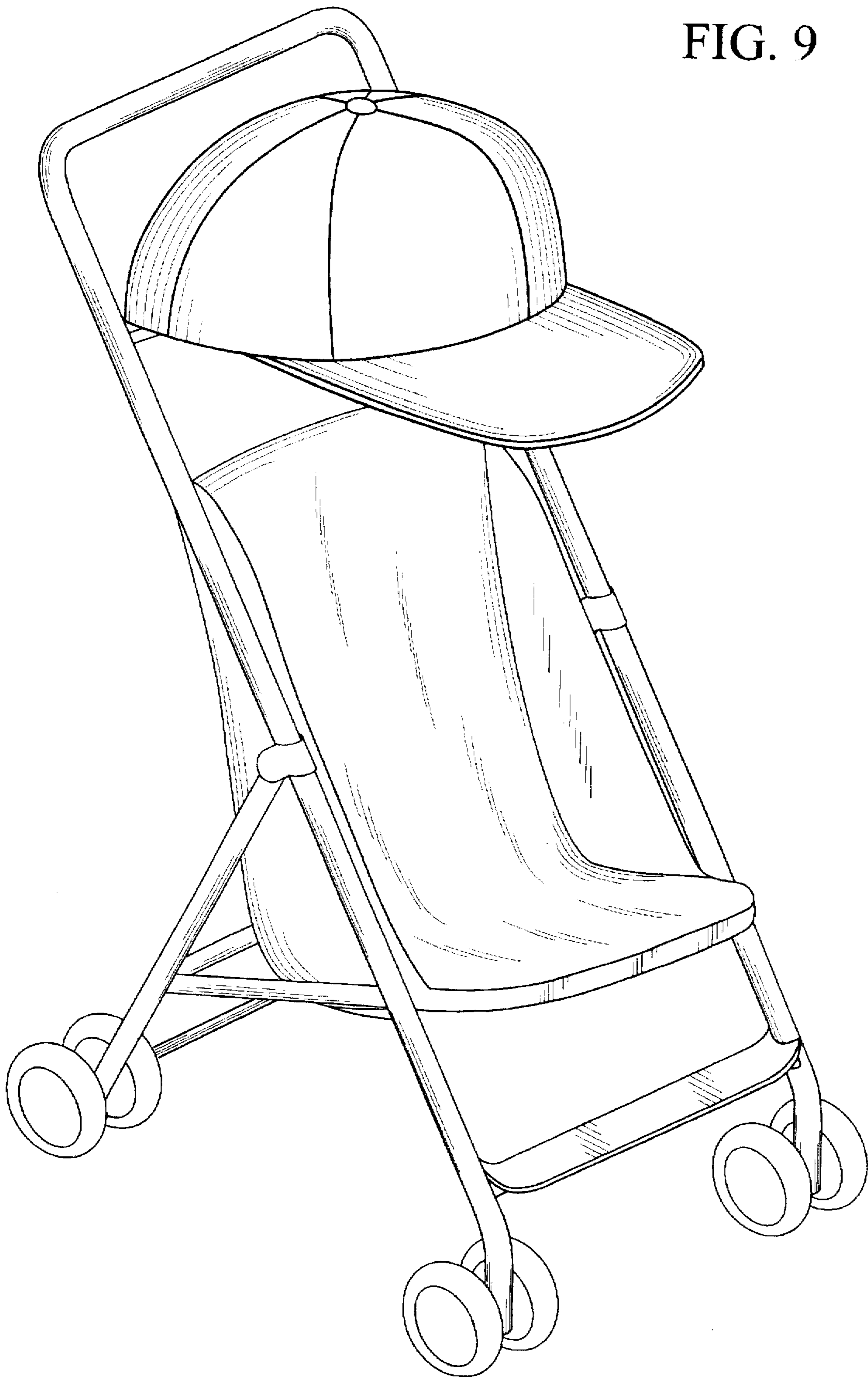

FIG. 10

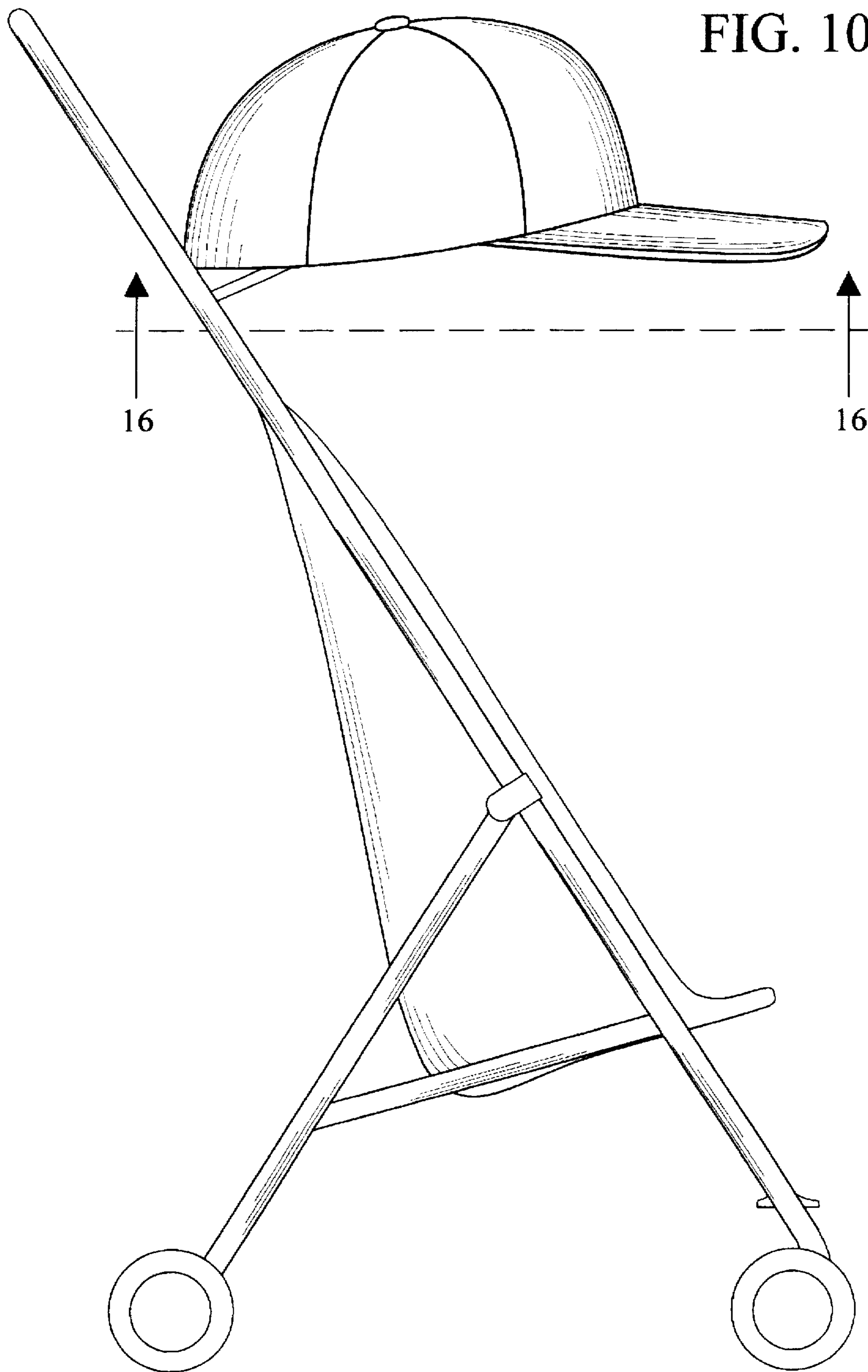
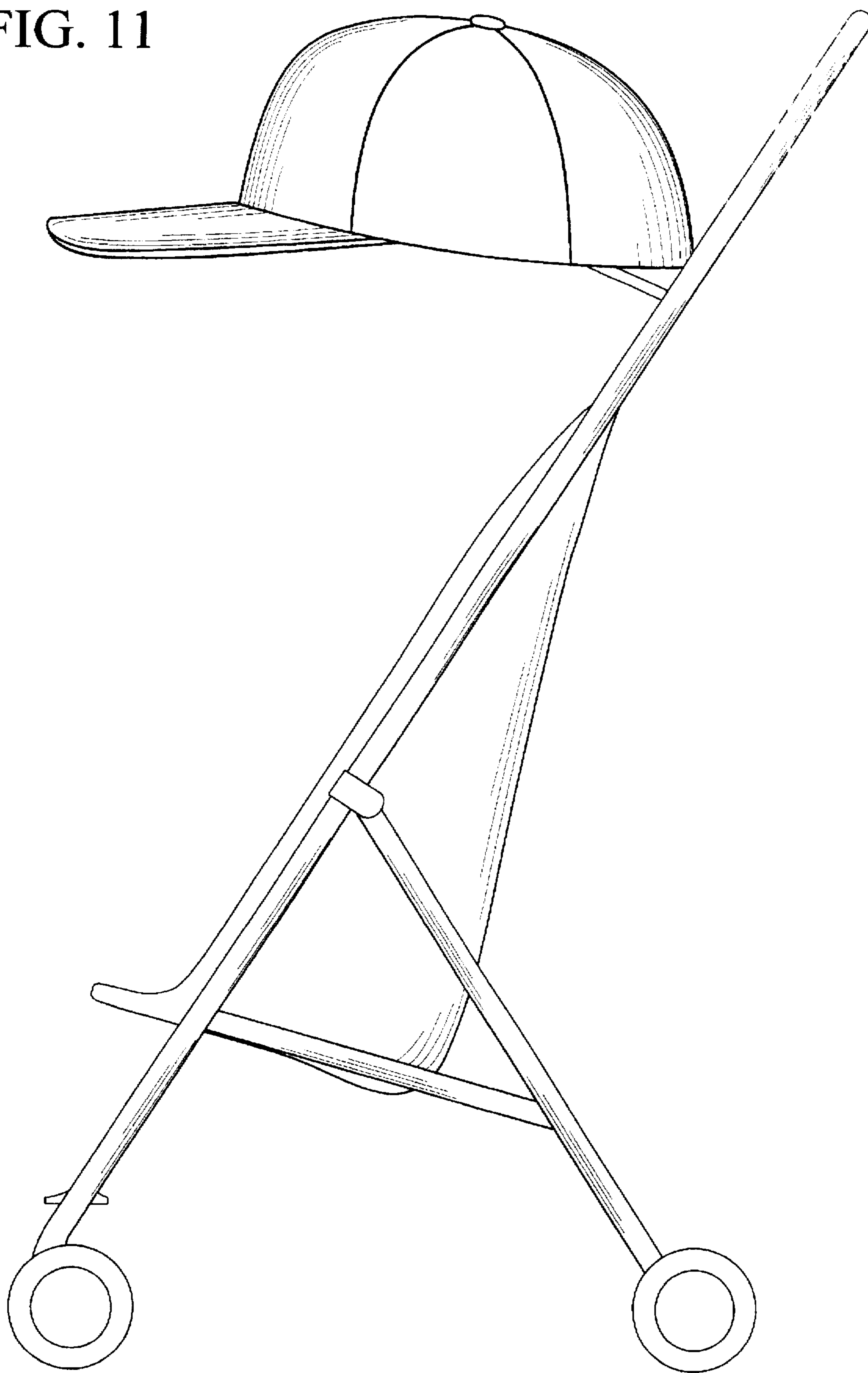

FIG. 11



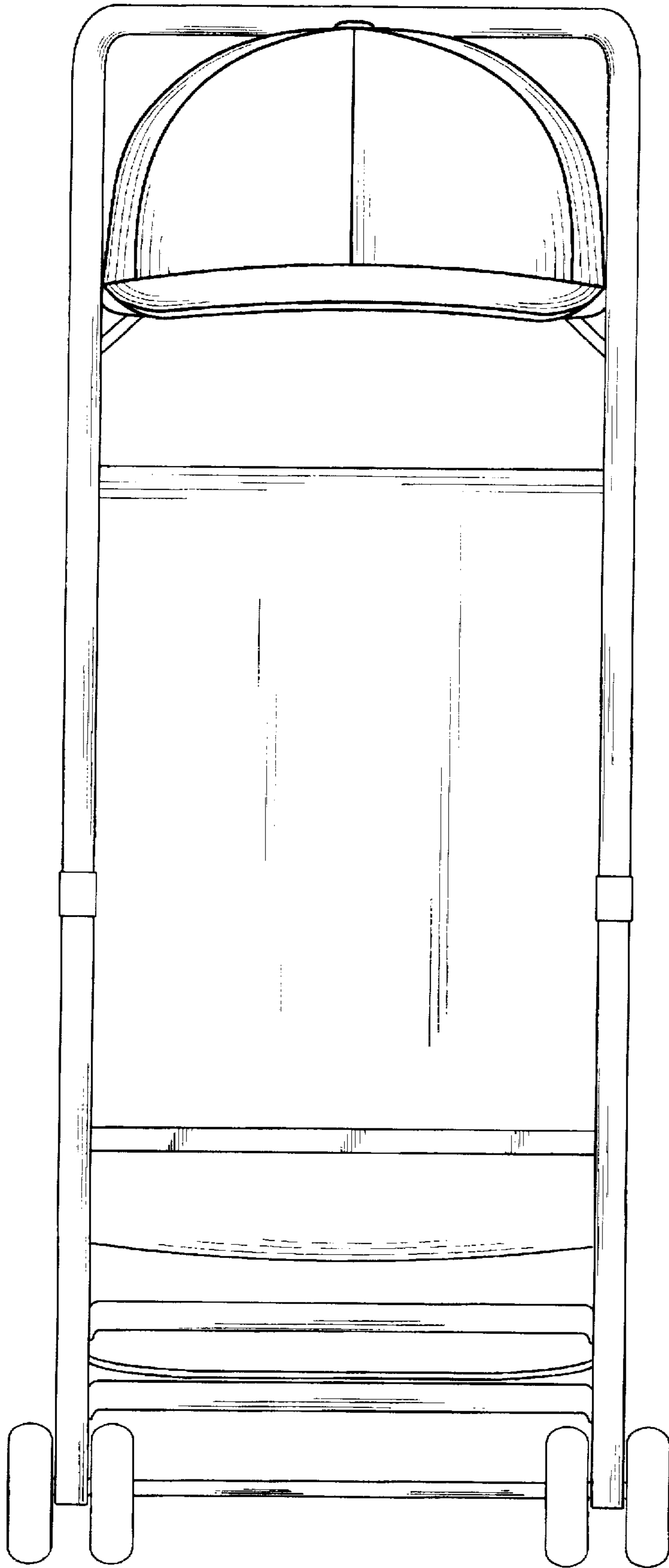

FIG. 12

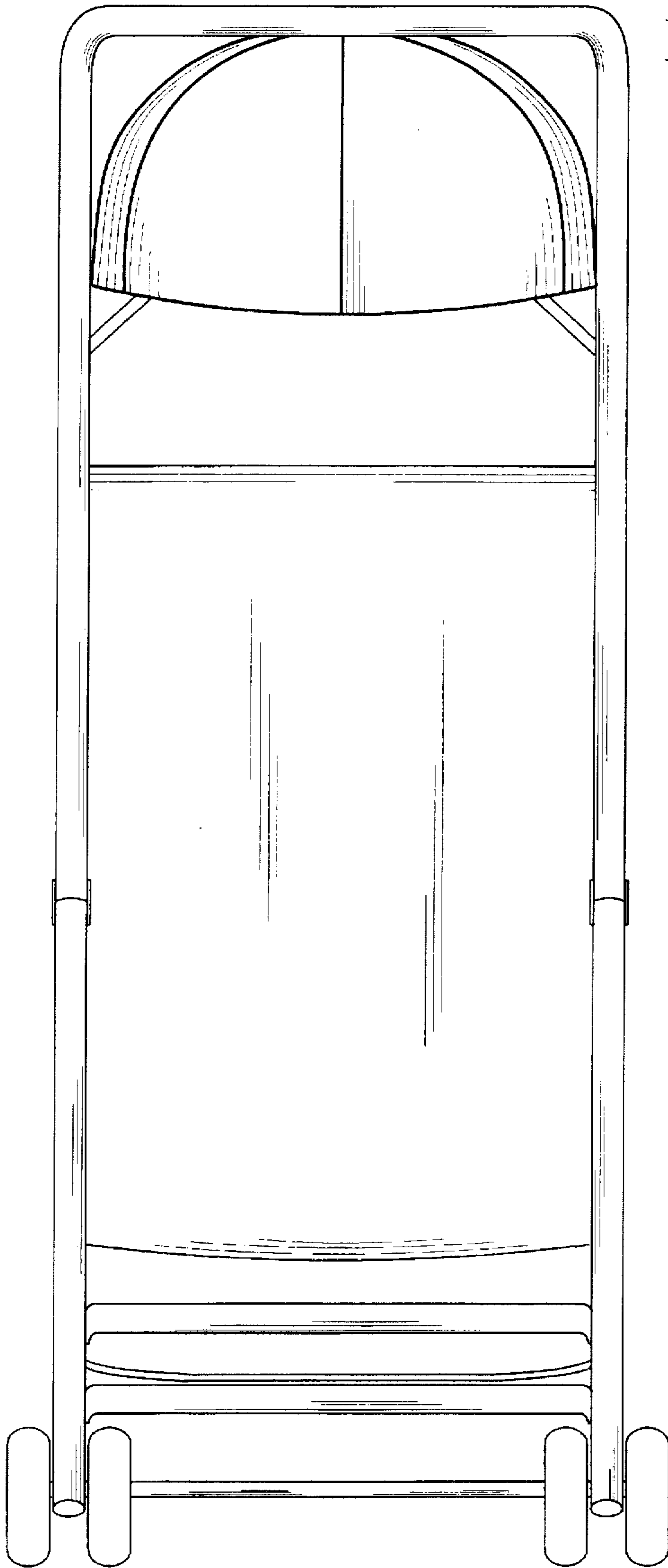

FIG. 13

FIG. 14

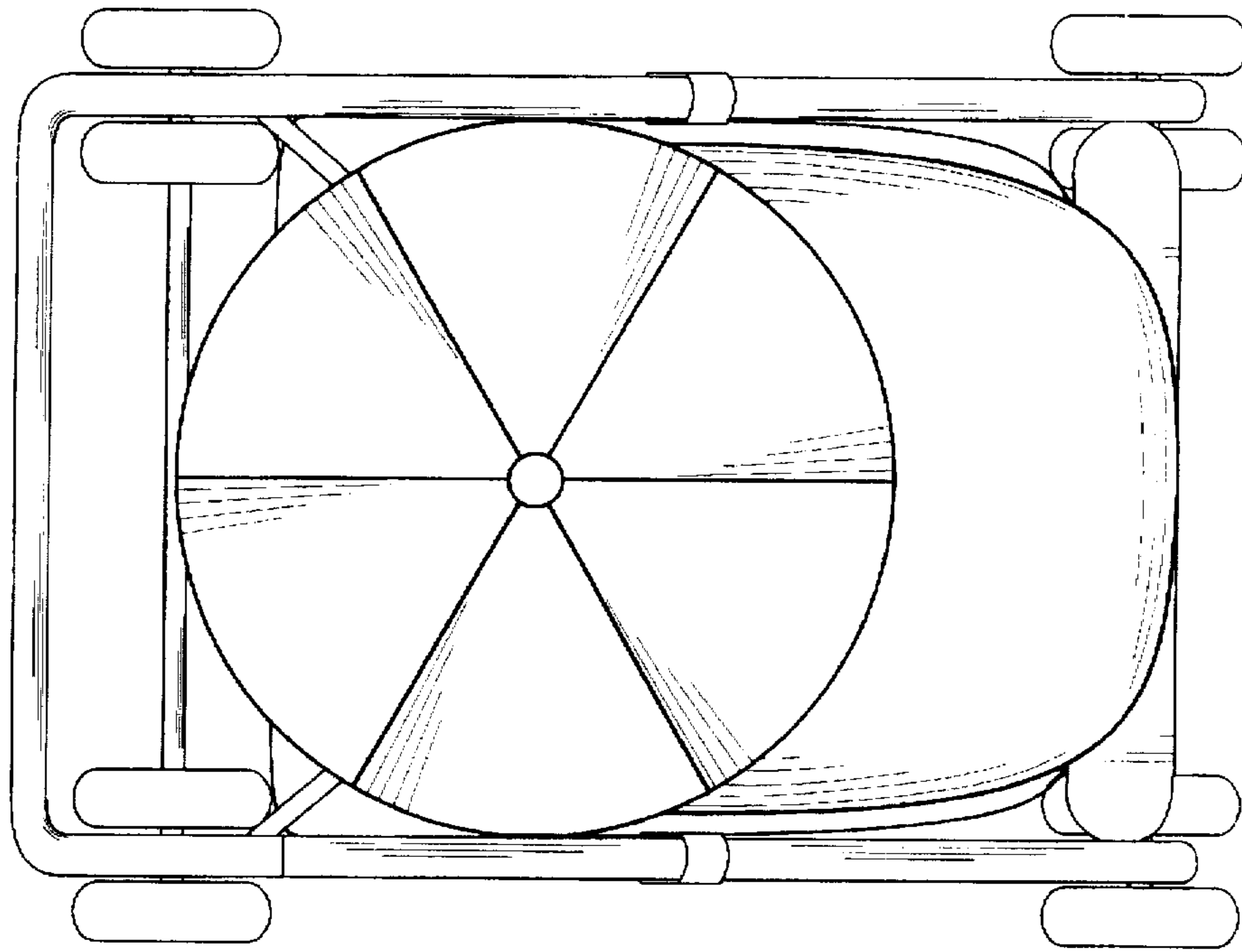
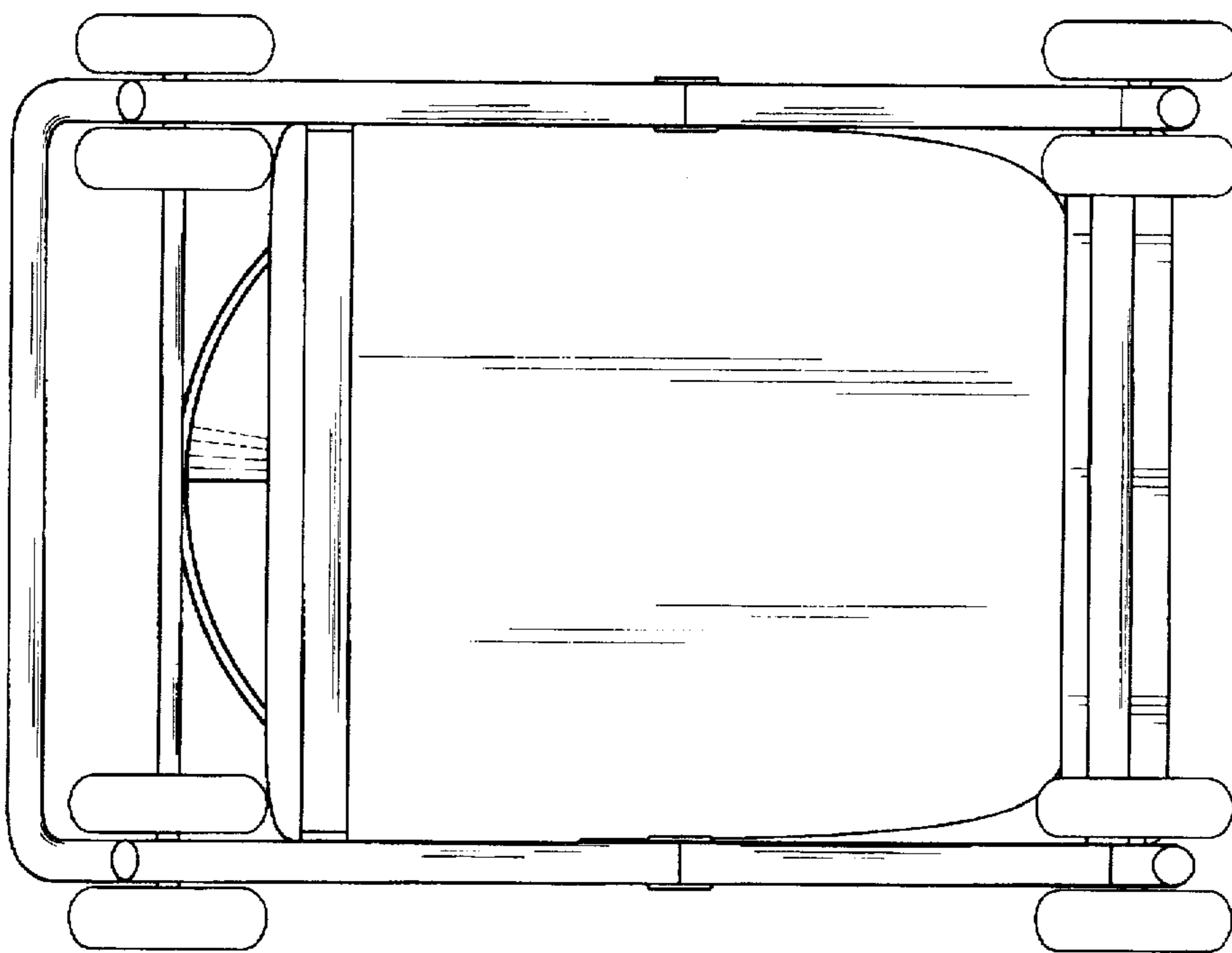

FIG. 15



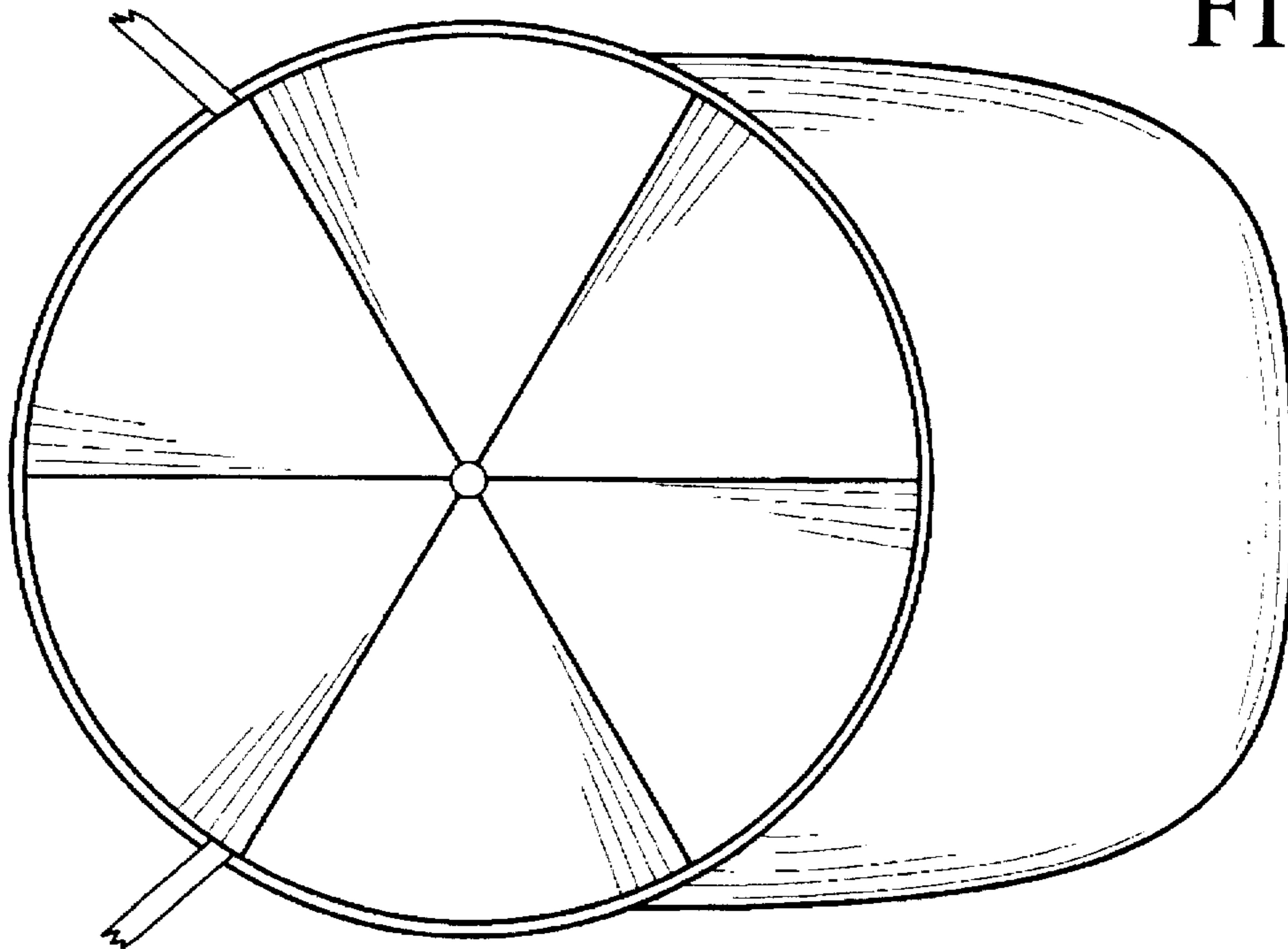

FIG. 16