



US00D388566S

United States Patent [19]

[11] Patent Number: **Des. 388,566**

Reid et al.

[45] Date of Patent: ****Dec. 30, 1997**

[54] DRAIN TRAY FOR A HOUSEHOLD APPLIANCE

[76] Inventors: **Ronald J. Reid, Box 2063; Ron J. Spiteri, 1165 Shady Oaks, both of Napa, Calif. 94558**

[**] Term: **14 Years**

[21] Appl. No.: **54,536**

[22] Filed: **May 16, 1996**

[51] LOC (6) Cl. **15-05**

[52] U.S. Cl. **D32/25**

[58] Field of Search **D15/89; D32/25, D32/55; D23/283, 303; 137/312, 313, 83, 62**

[56] References Cited

U.S. PATENT DOCUMENTS

D. 309,571	7/1990	Lehman	D15/89
D. 337,154	7/1993	Simpson	D23/283 X
D. 358,404	5/1995	Andrews	D15/89
2,133,497	10/1938	Winston	D23/383 X
3,304,950	2/1967	Hubert	137/312
4,889,155	12/1989	Trotter, Sr.	137/312
4,903,723	2/1990	Sublett	137/312

Primary Examiner—Ted Shooman
Assistant Examiner—Mitchell I. Siegel
Attorney, Agent, or Firm—Harold D. Messner

[57] CLAIM

The ornamental design for a drain tray for a household appliance, as shown and described.

DESCRIPTION

FIG. 1 is an exploded top perspective view of a drain tray for a household appliance showing our new design;
 FIG. 2 is an enlarged front elevational view of the removable front wall;
 FIG. 3 is a left side view of FIG. 2, the undisclosed opposite side being a mirror image;
 FIG. 4 is a rear elevational view of FIG. 2;
 FIG. 5 is a top plan view of FIG. 2;
 FIG. 6 is a bottom plan view of FIG. 2;
 FIG. 7 is an enlarged cross section taken along line 7—7 of FIG. 2;
 FIG. 8 is an enlarged cross section taken along line 8—8 of FIG. 3;
 FIG. 9 is a front elevational view of the base as disclosed in FIG. 1;
 FIG. 10 is a right side elevational of FIG. 9, the undisclosed opposite side being a mirror image;
 FIG. 11 is a reduced scale top plan view of FIG. 9;
 FIG. 12 is a bottom plan view of FIG. 11;
 FIG. 13 is a rear elevational view of FIG. 9;
 FIG. 14 is an enlarged fragmented cross section taken along line 14—14 of FIG. 10; and,
 FIG. 15 is a top perspective of FIG. 1, the broken line showing of a fragmented appliance is for illustrative purposes only and forms no part of the claimed design.
 The fragmented FIGURES in the drawings are shown for ease of illustration.

1 Claim, 4 Drawing Sheets

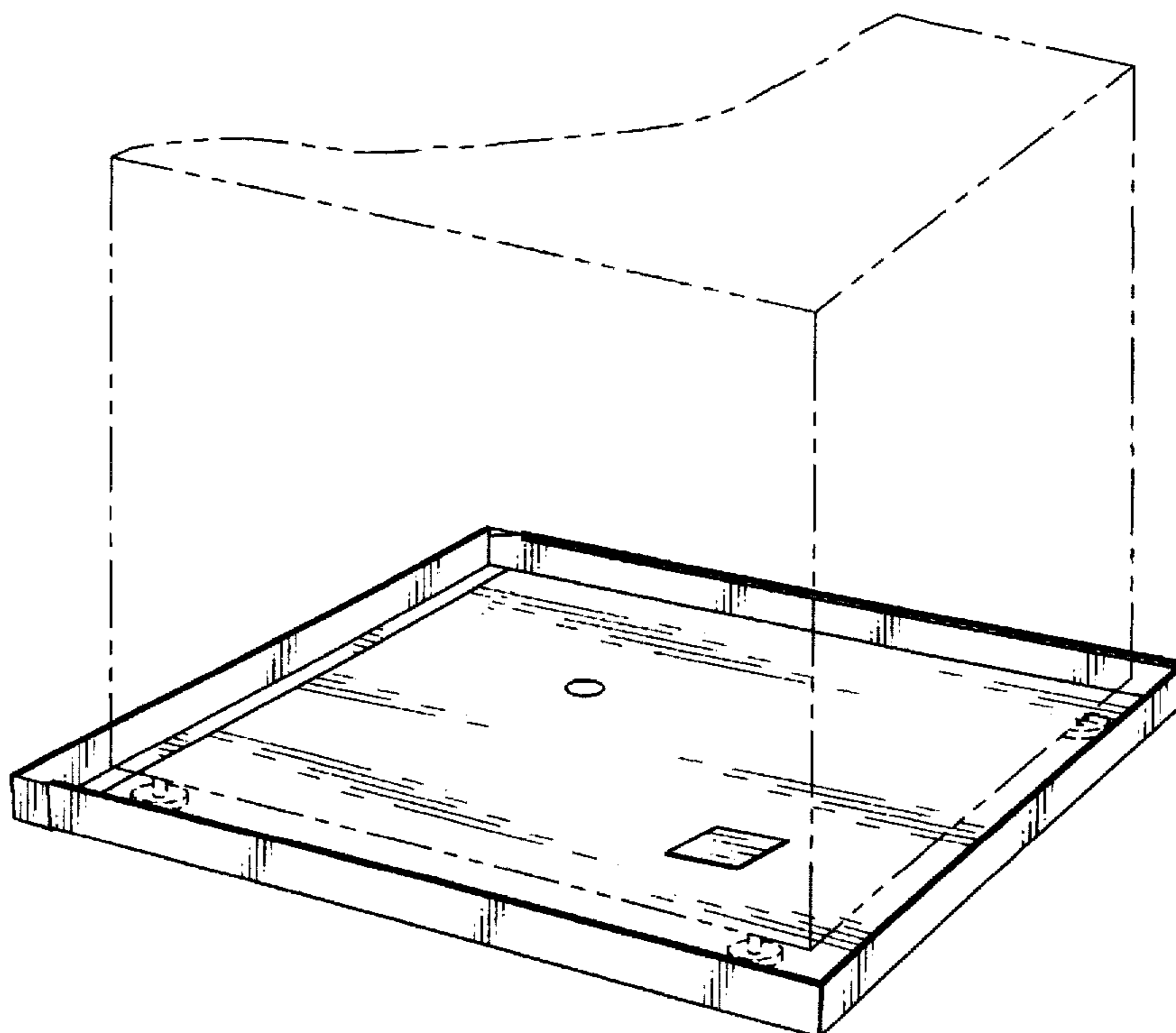

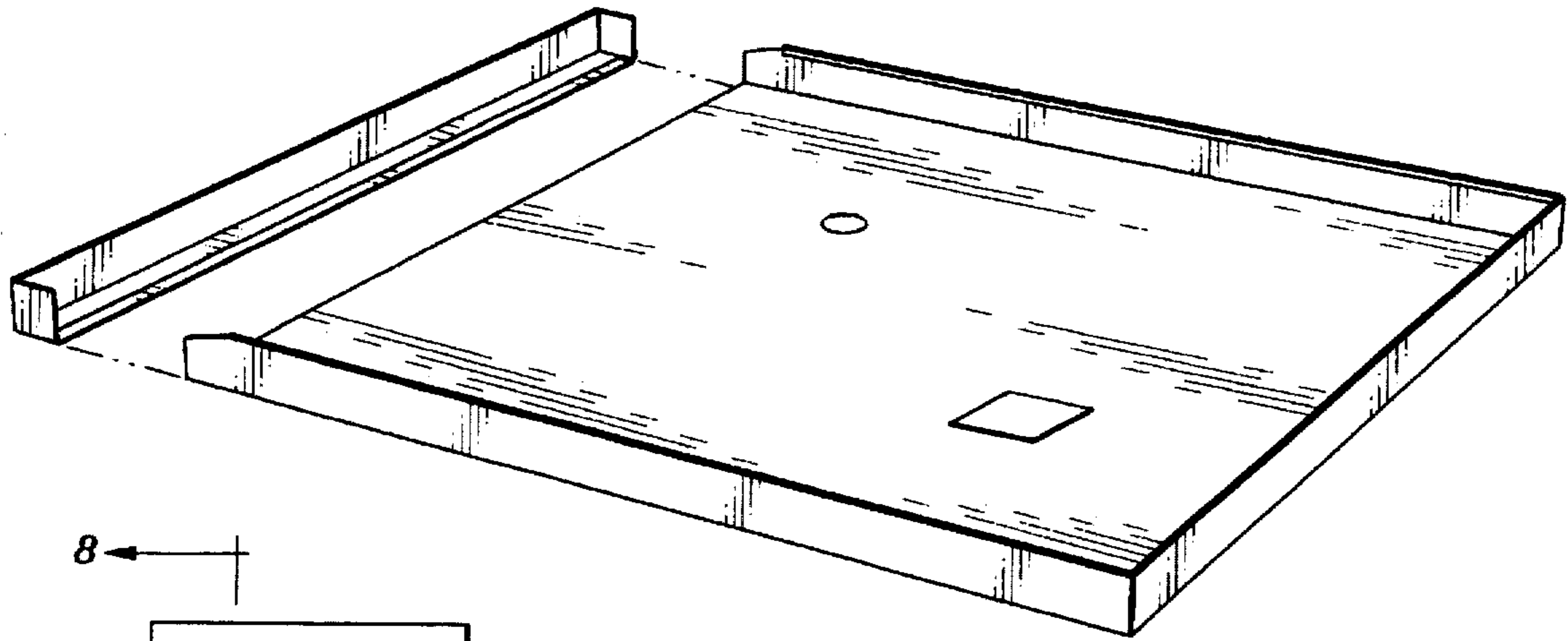

Fig. 1

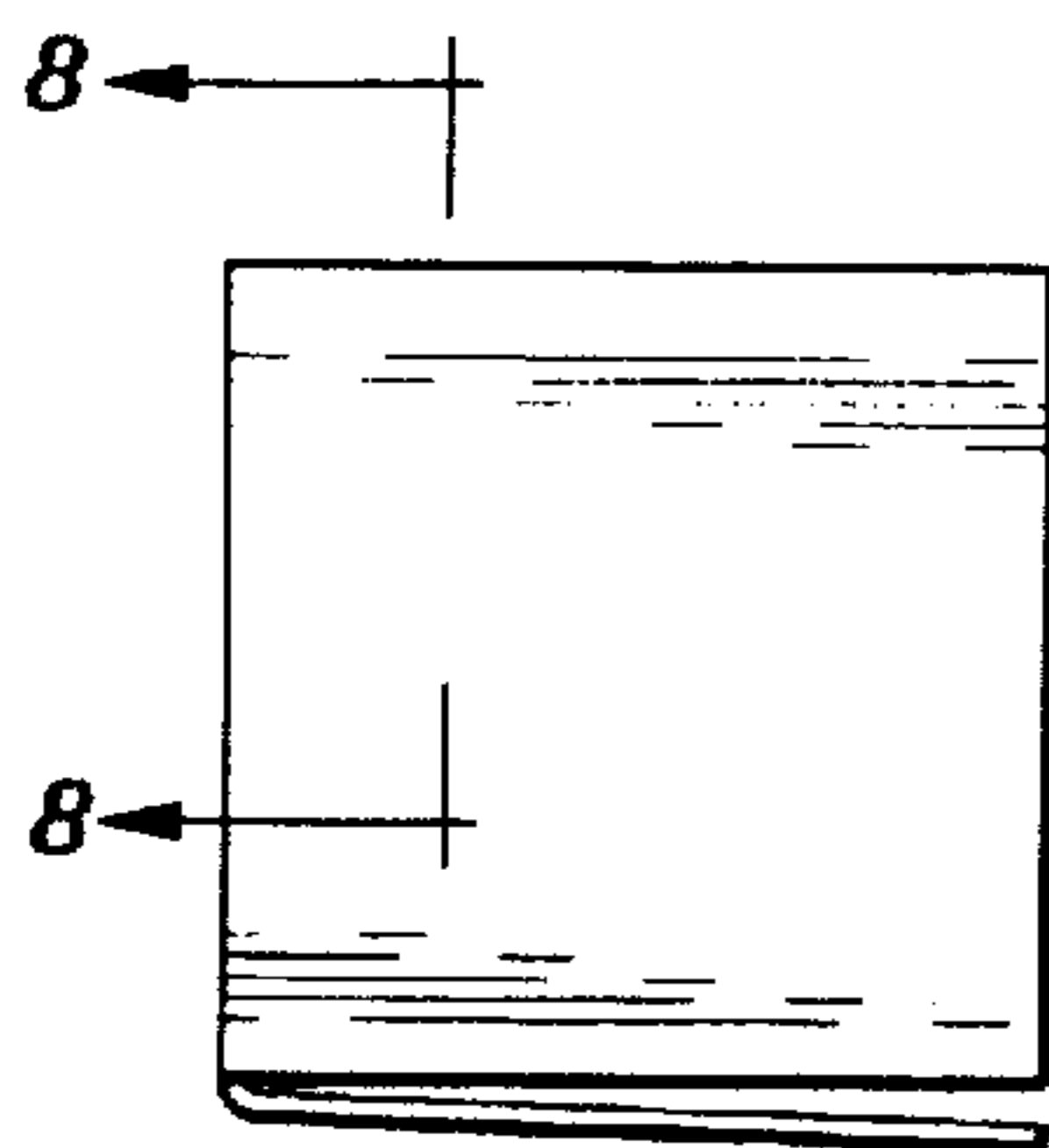

Fig. 3

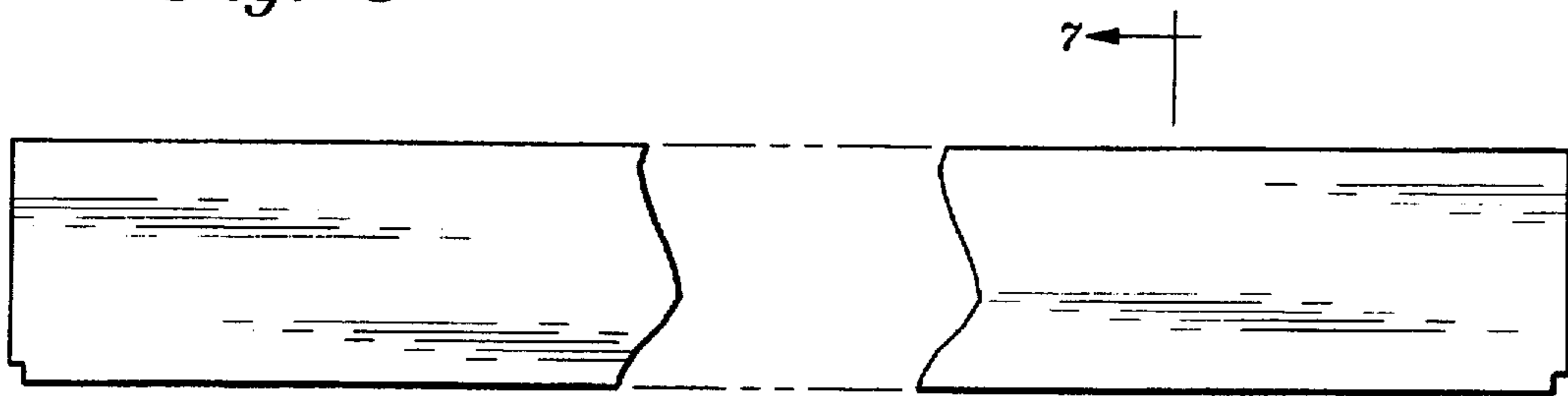

Fig. 2

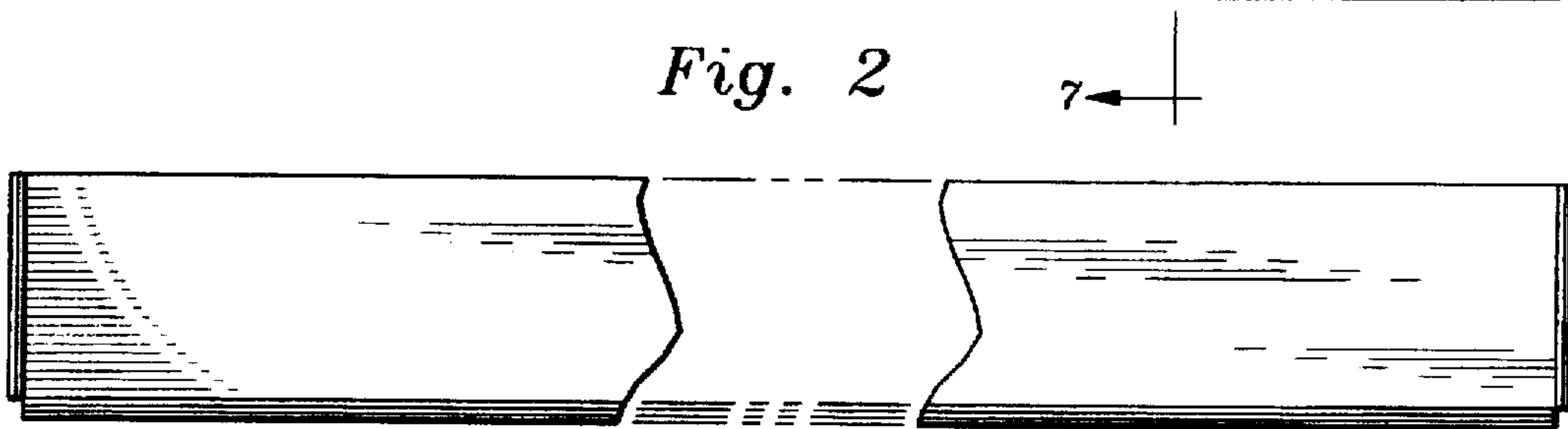

Fig. 4

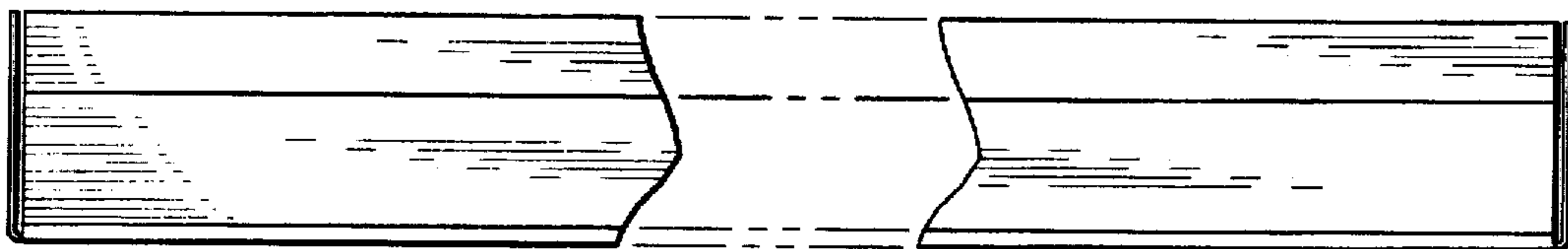

Fig. 5

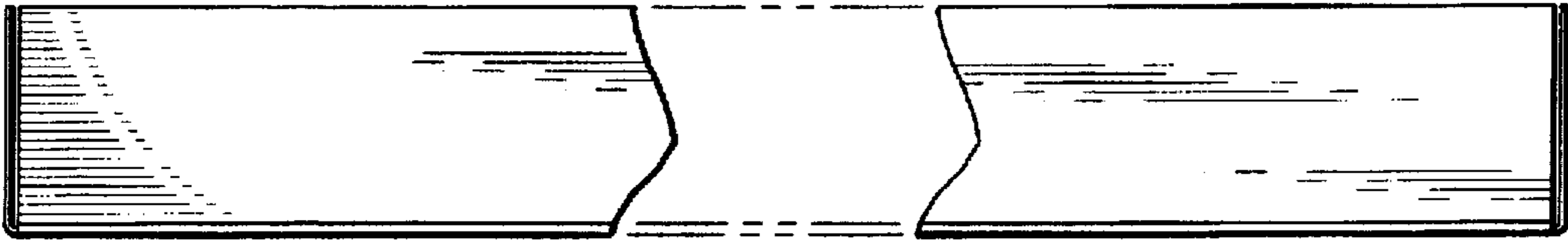

Fig. 6

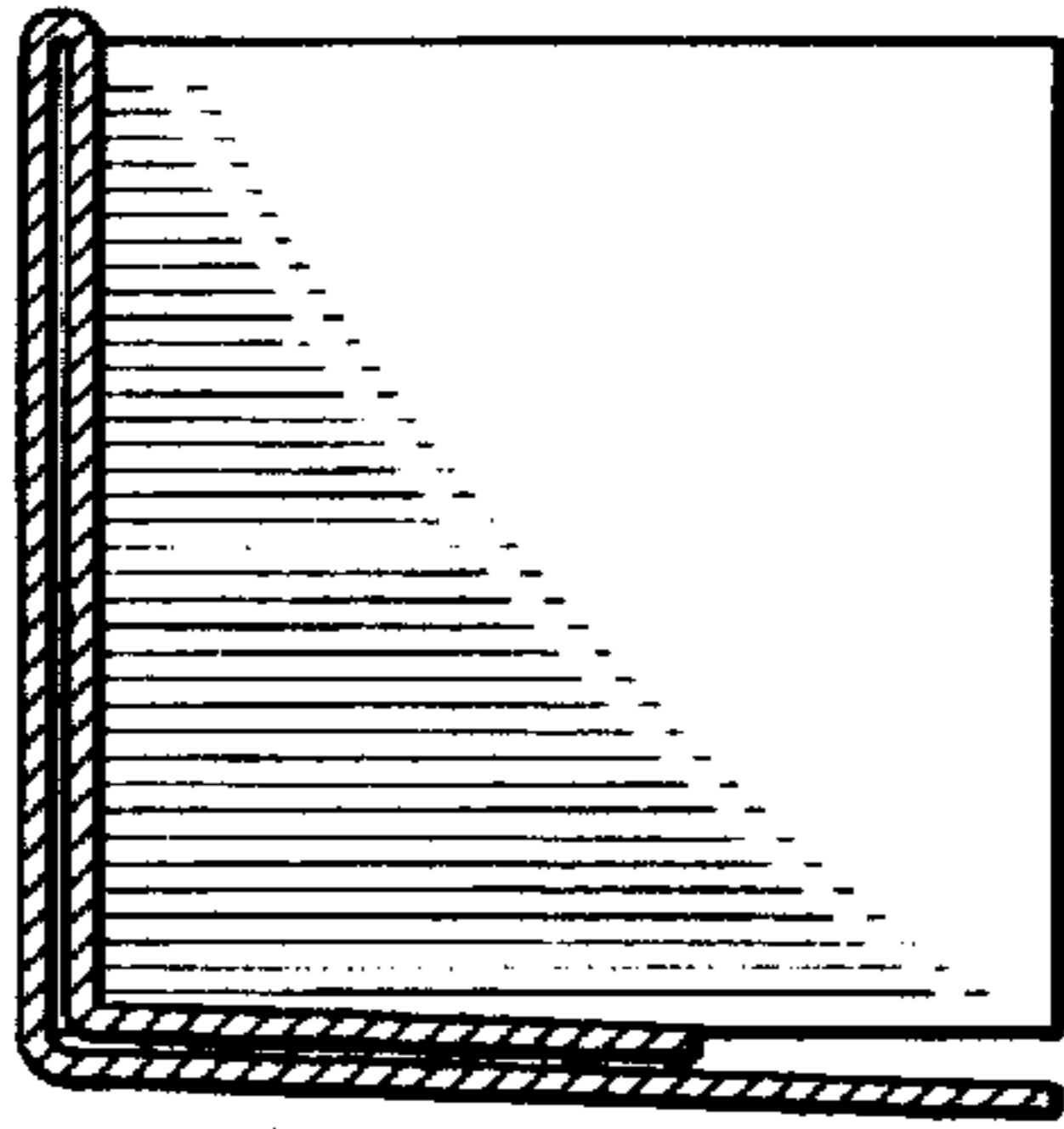

Fig. 7

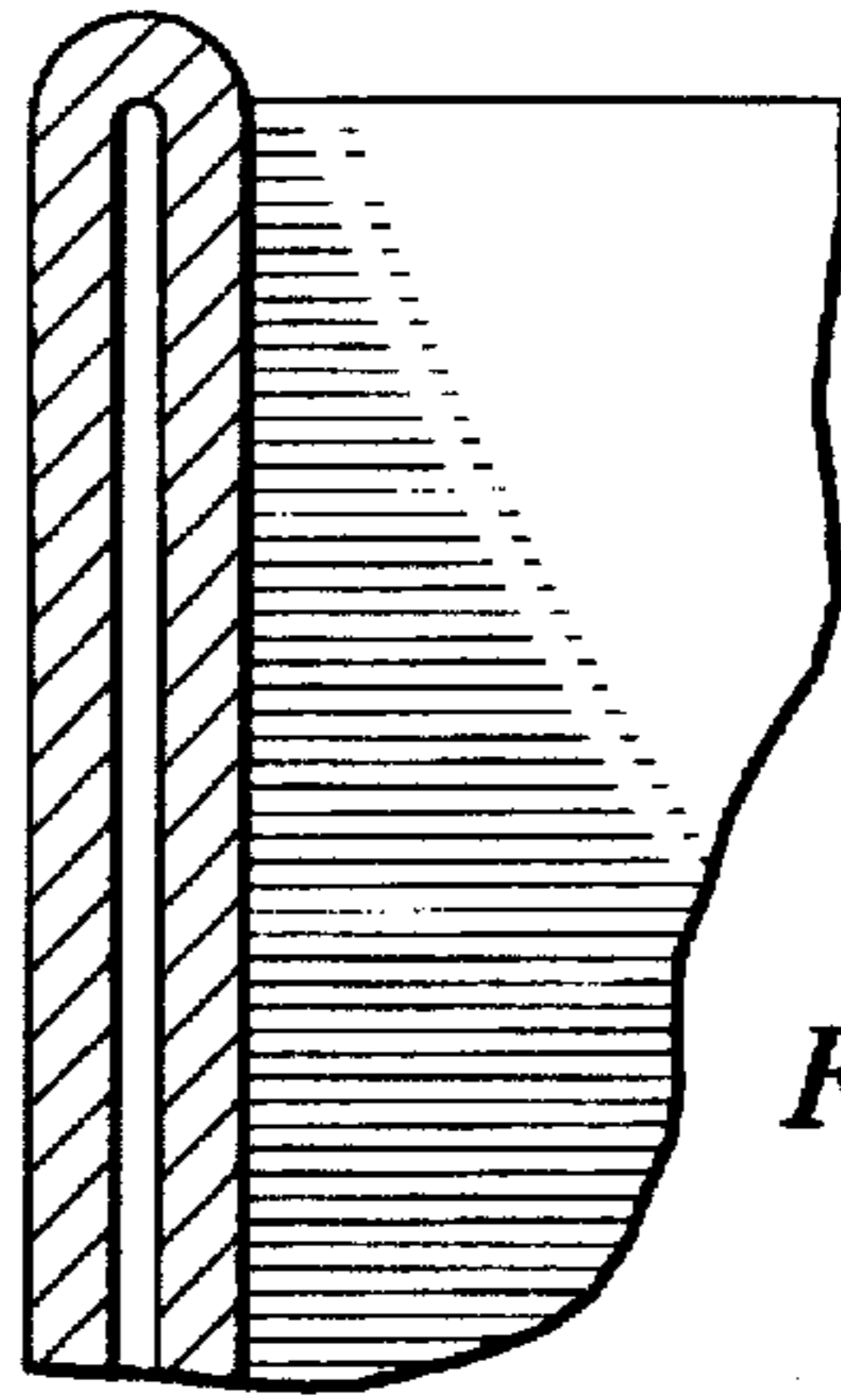

Fig. 8

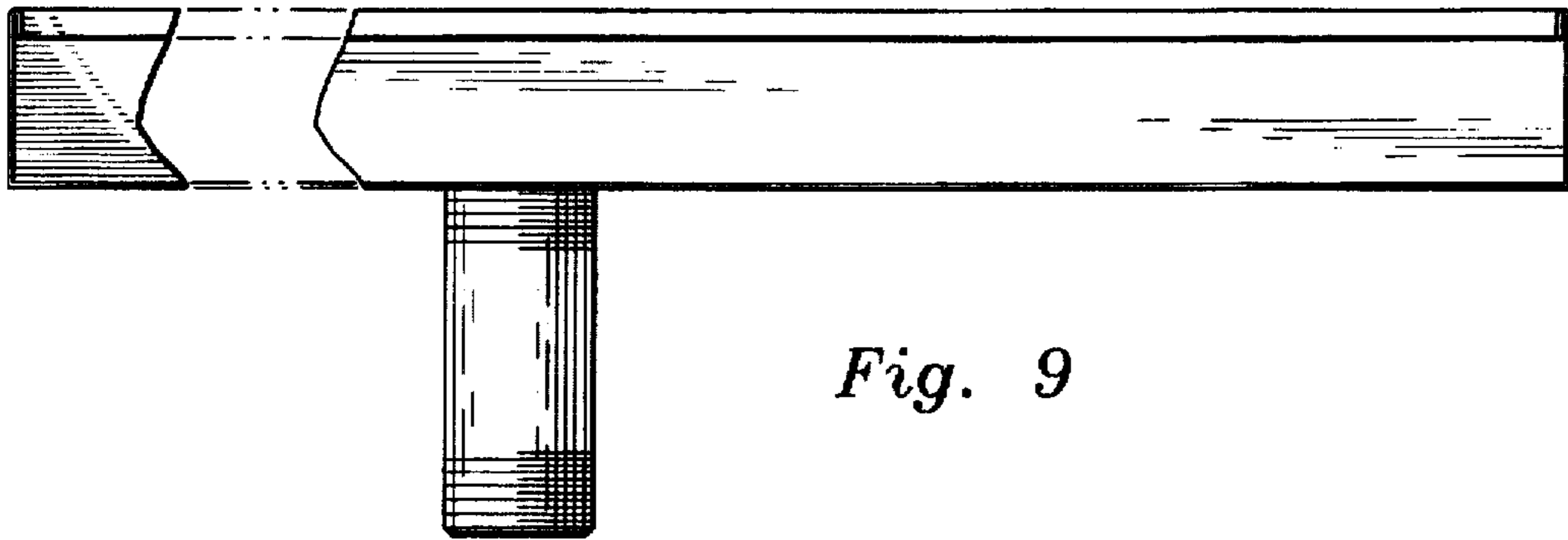

Fig. 9

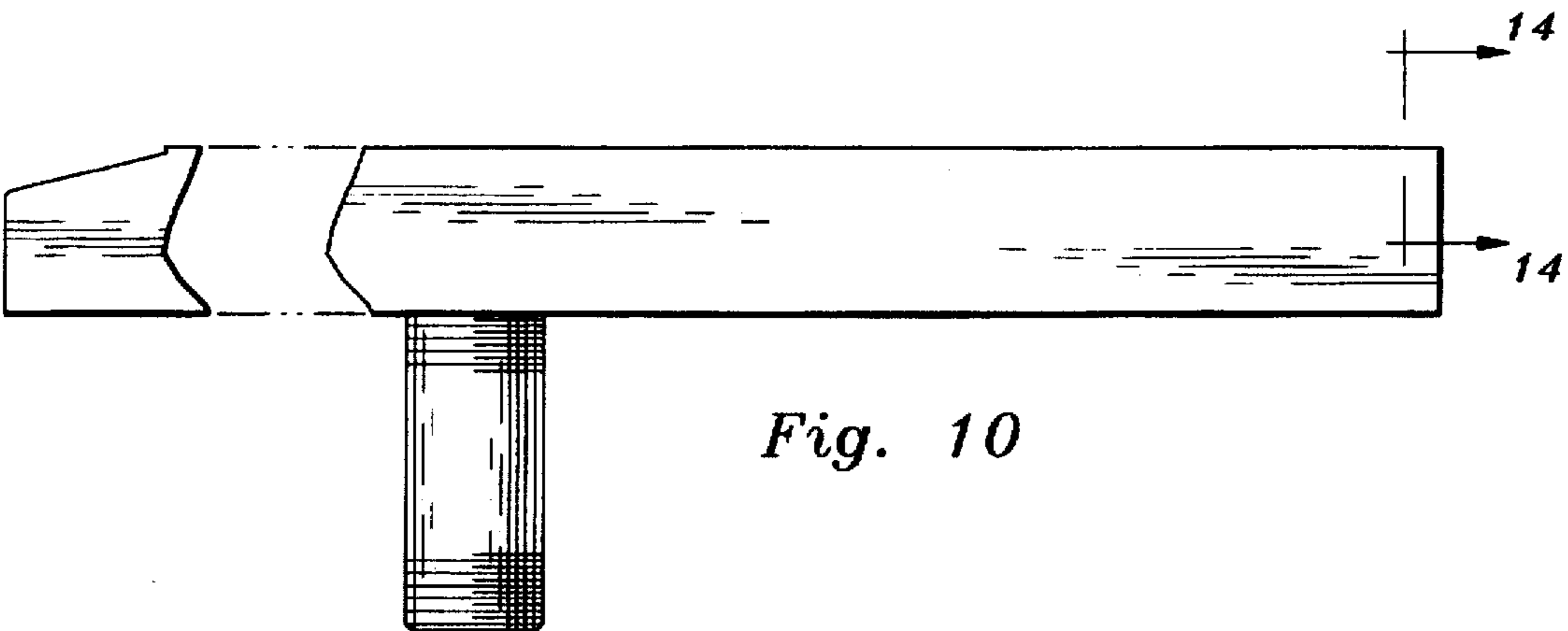

Fig. 10

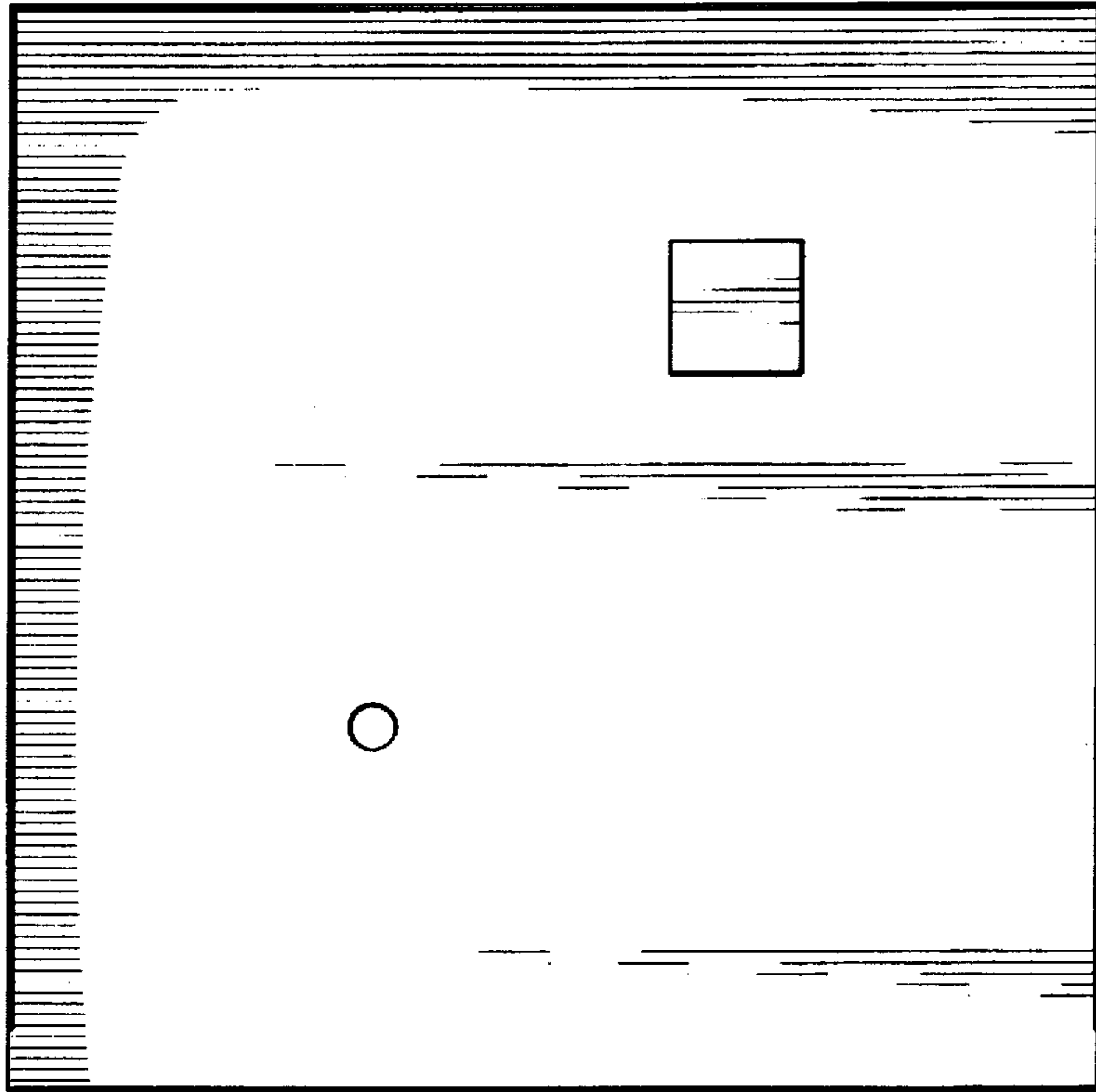

Fig. 11

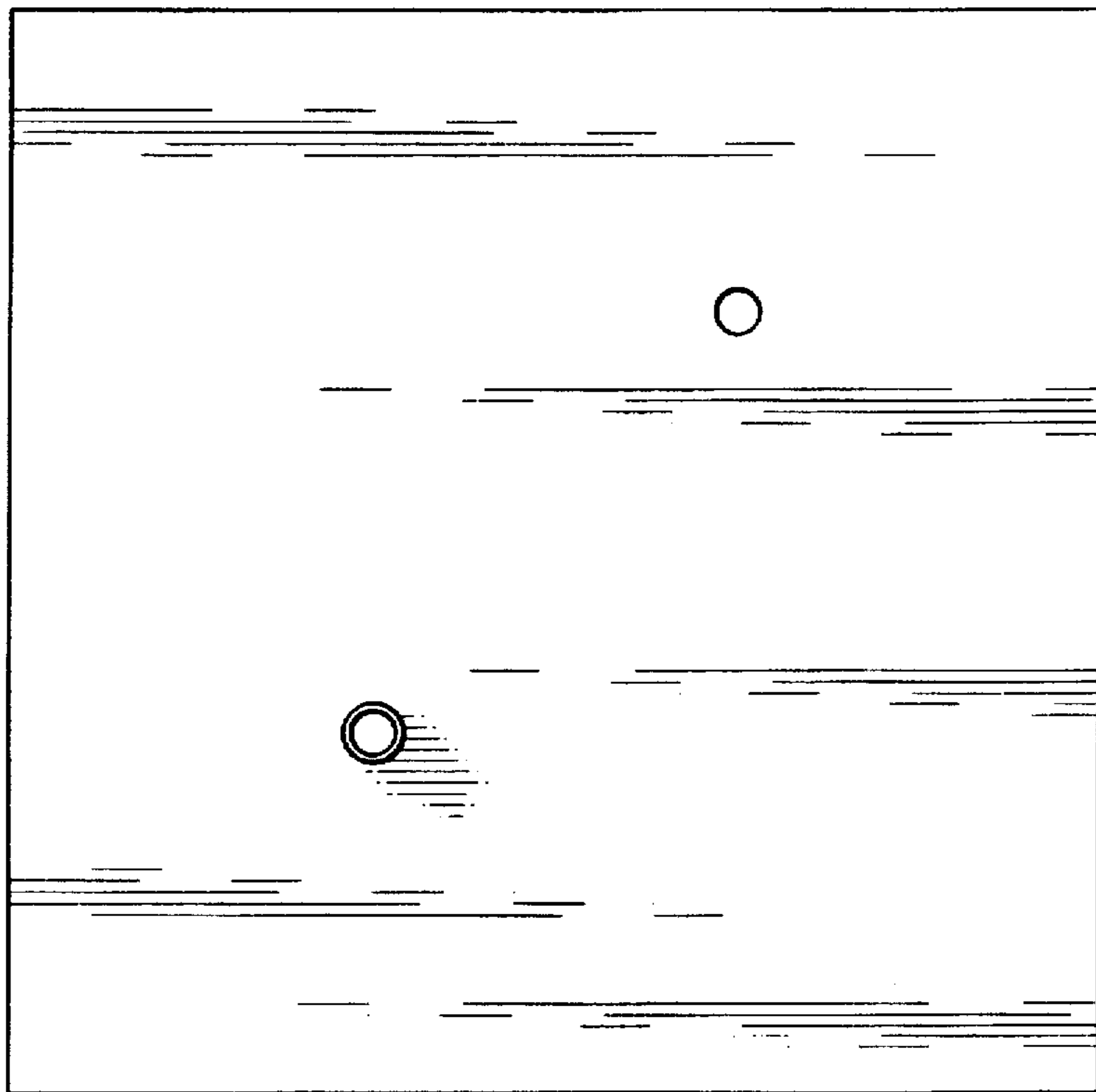

Fig. 12

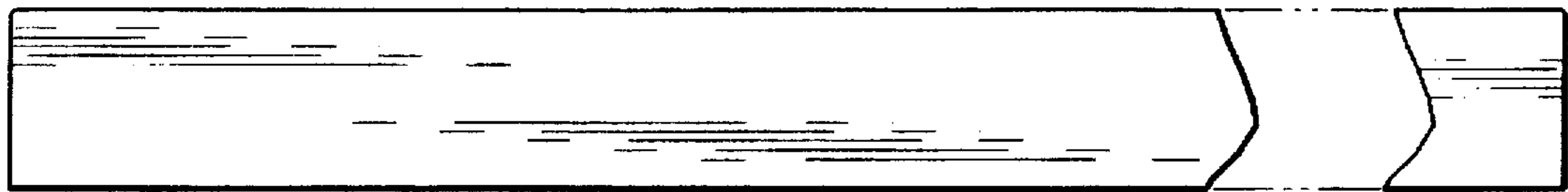

Fig. 13

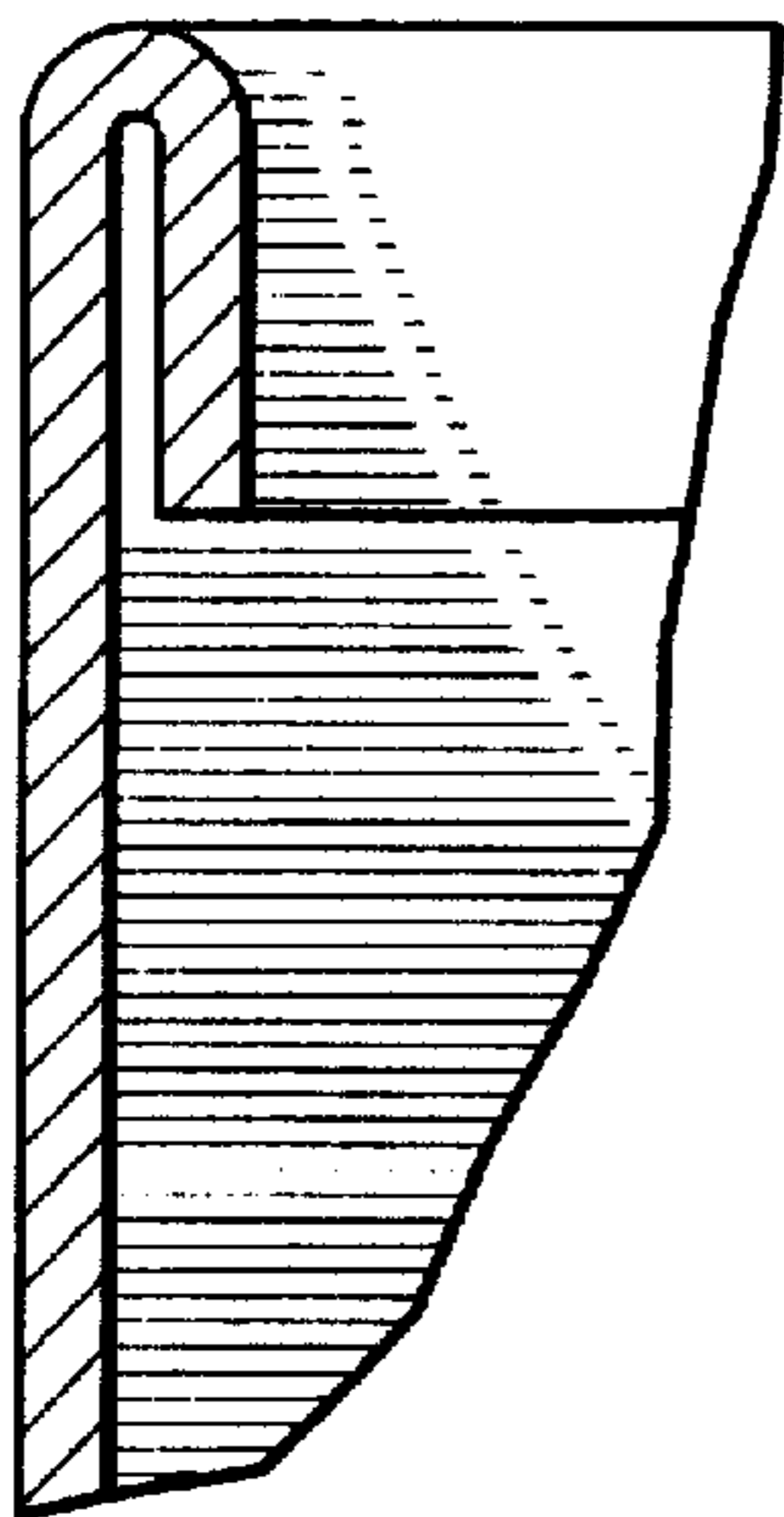

Fig. 14

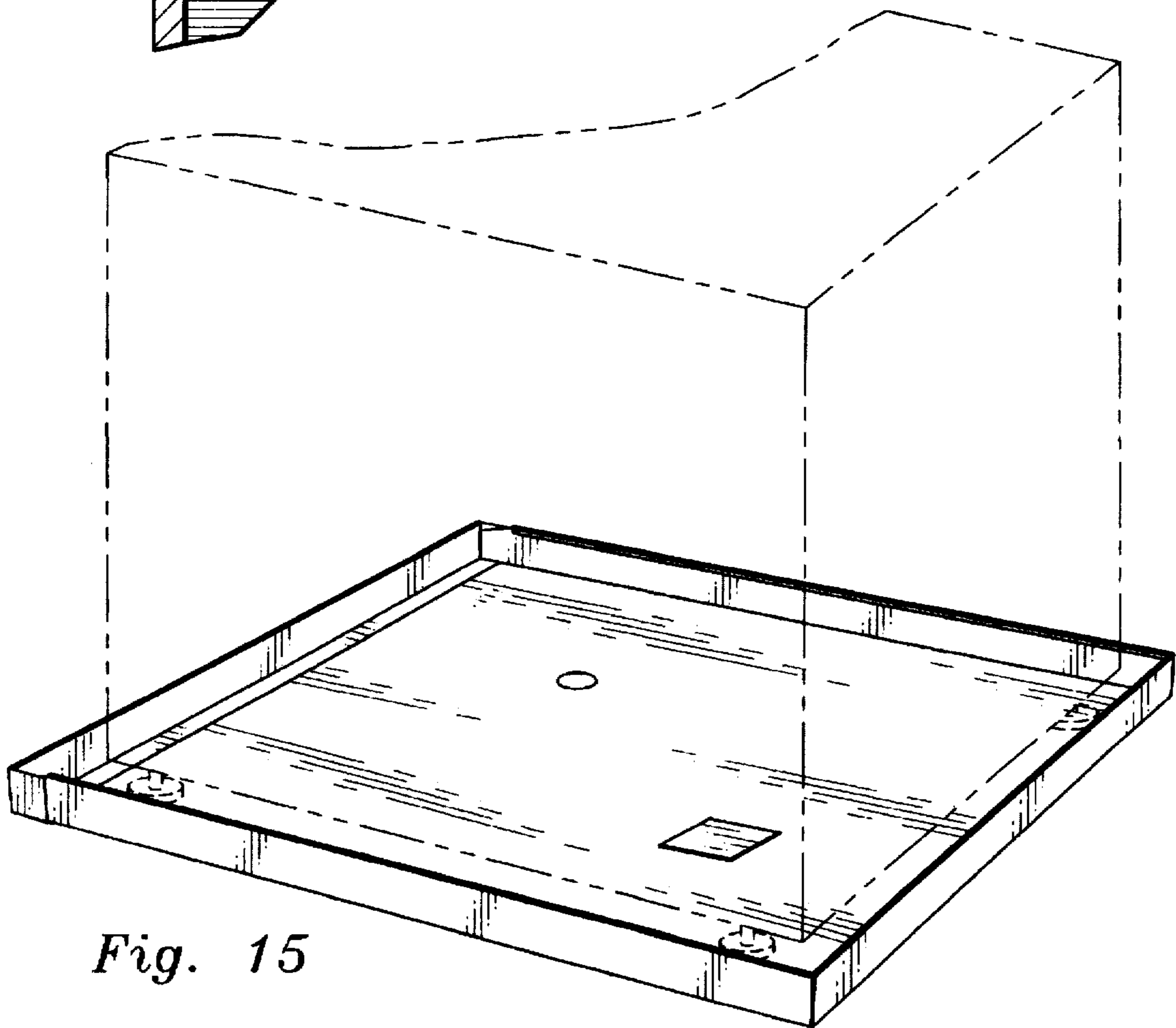

Fig. 15