



US00D388511S

United States Patent [19]

[11] Patent Number: **Des. 388,511**

Jane' et al.

[45] Date of Patent: ****Dec. 30, 1997**

[54] HUMIDIFIER HOUSING UNIT

[75] Inventors: **Rodney Jane'**, Westboro, Mass.;
Jui-Shang Wang, Taipei, Taiwan;
Stanley Gresens, Homewood; **Gregory Holderfield**, Palatine, both of Ill.

[73] Assignee: **Duracraft Corp.**, Southborough, Mass.

[**] Term: **14 Years**

[21] Appl. No.: **45,815**

[22] Filed: **Oct. 30, 1995**

[51] LOC (6) CL **23-04**

[52] U.S. Cl. **D23/358; D23/356**

[58] Field of Search **D23/356-363;**
392/403-406, 394; 261/72, 107, 120, 104;
422/120, 123

[56] References Cited

U.S. PATENT DOCUMENTS

D. 255,712	7/1980	Chihara	D23/146
D. 279,215	6/1985	Mango et al.	D23/146
D. 287,274	12/1986	Crowley et al.	D23/146
D. 287,275	12/1986	Uchida	D23/146
D. 287,755	1/1987	Imai et al.	D23/146
D. 288,596	3/1987	Young Se	D23/146
D. 288,597	3/1987	Young Se	D23/146
D. 289,325	4/1987	Nishikawa	D23/146
D. 290,168	6/1987	Watanabe et al.	D23/146
D. 294,292	2/1988	Suzuki	D23/356
D. 298,351	11/1988	Ihlenfeld	D23/356
D. 304,366	10/1989	Meyers	D23/356
D. 305,358	1/1990	Martinez	D23/356
D. 305,562	1/1990	Martinez	D23/356
D. 306,063	2/1990	Chiu et al.	D23/356
D. 307,653	5/1990	Weirsmann et al.	D32/1
D. 308,413	6/1990	Wong	D23/356
D. 309,009	7/1990	Herritz	D23/362
D. 309,656	7/1990	Lee	D23/356
D. 316,598	4/1991	Morooka	D23/356
D. 320,071	9/1991	Cook	D23/356
D. 320,440	10/1991	Chiu	D23/356

D. 321,048	10/1991	Chiu	D23/356
D. 322,121	12/1991	Chiu	D23/356
D. 328,342	7/1992	Pasch et al.	D23/356
D. 330,074	10/1992	Wang et al.	D23/356
D. 335,339	5/1993	Glucksman et al.	D23/356
D. 335,340	5/1993	Marvin, Jr.	D23/356
D. 335,341	5/1993	O'Grady	D23/360
D. 336,511	6/1993	Chiu et al.	D23/356
D. 336,761	6/1993	Chan	D23/356
D. 337,634	7/1993	Copland et al.	D23/356
D. 342,989	1/1994	Wallen	D23/357
D. 344,790	3/1994	Glucksman et al.	D23/356
D. 349,334	8/1994	O'Grady et al.	D23/360
D. 357,310	4/1995	Chiu et al.	D23/356
D. 358,461	5/1995	Barker et al.	D23/356
D. 358,874	5/1995	Cunning	D23/356
D. 359,552	6/1995	Chiu et al.	D23/356

OTHER PUBLICATIONS

1994-95 Owner's Guide for Holmes Products Corp.'s HM-2060 FP Cool Mist Humidifier.

1994 Promotional Literature For Duracraft Corporation's Natural Cool Moisture™ Humidifier Model No. DH-836.

Primary Examiner—Lisa Lichtenstein

Attorney, Agent, or Firm—Morgan & Finnegan

[57] CLAIM

The ornamental design for a humidifier housing unit, as shown and described.

DESCRIPTION

FIG. 1 is a perspective view of the design for a humidifier housing unit in accordance with the present invention;

FIG. 2 is a front elevational view thereof;

FIG. 3 is a rear elevational view thereof;

FIG. 4 is a left side elevational view thereof;

FIG. 5 is a right side elevational view thereof;

FIG. 6 is a bottom plan view thereof; and,

FIG. 7 is a top plan view thereof.

The broken-line showing of environmental structure in FIGS. 1-6 is for illustrative purposes only and forms no part of the claimed design.

1 Claim, 7 Drawing Sheets

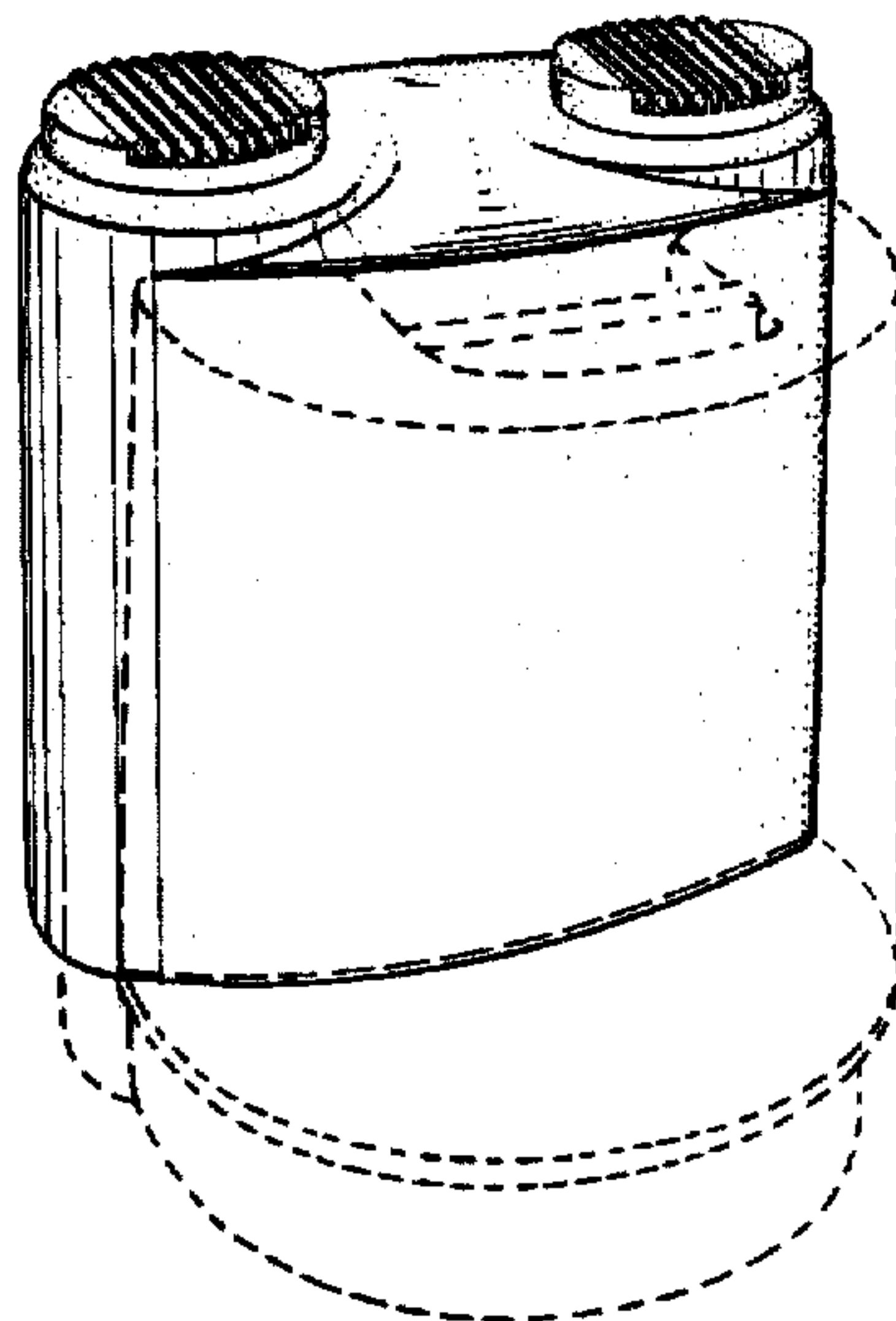

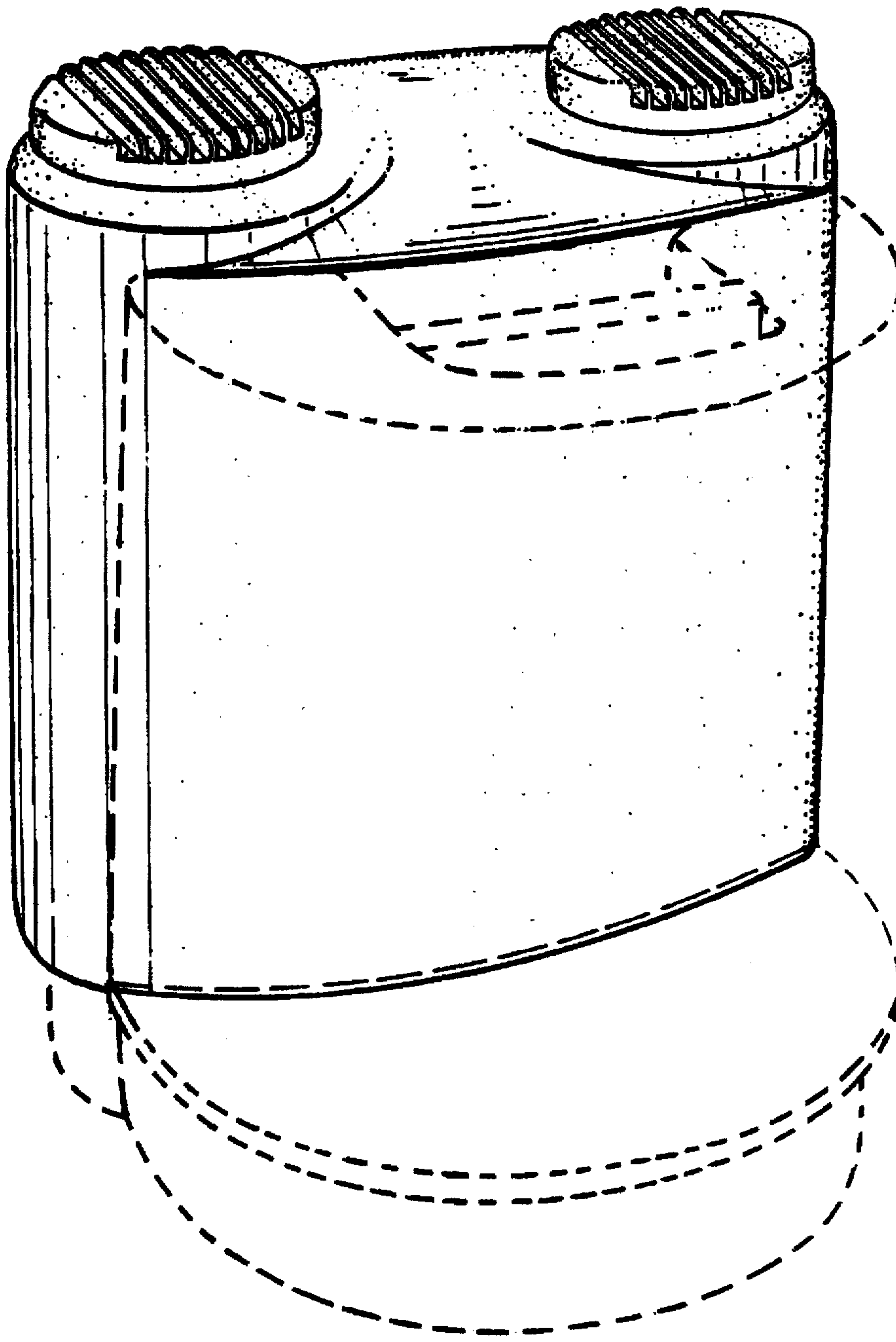

FIG. 1

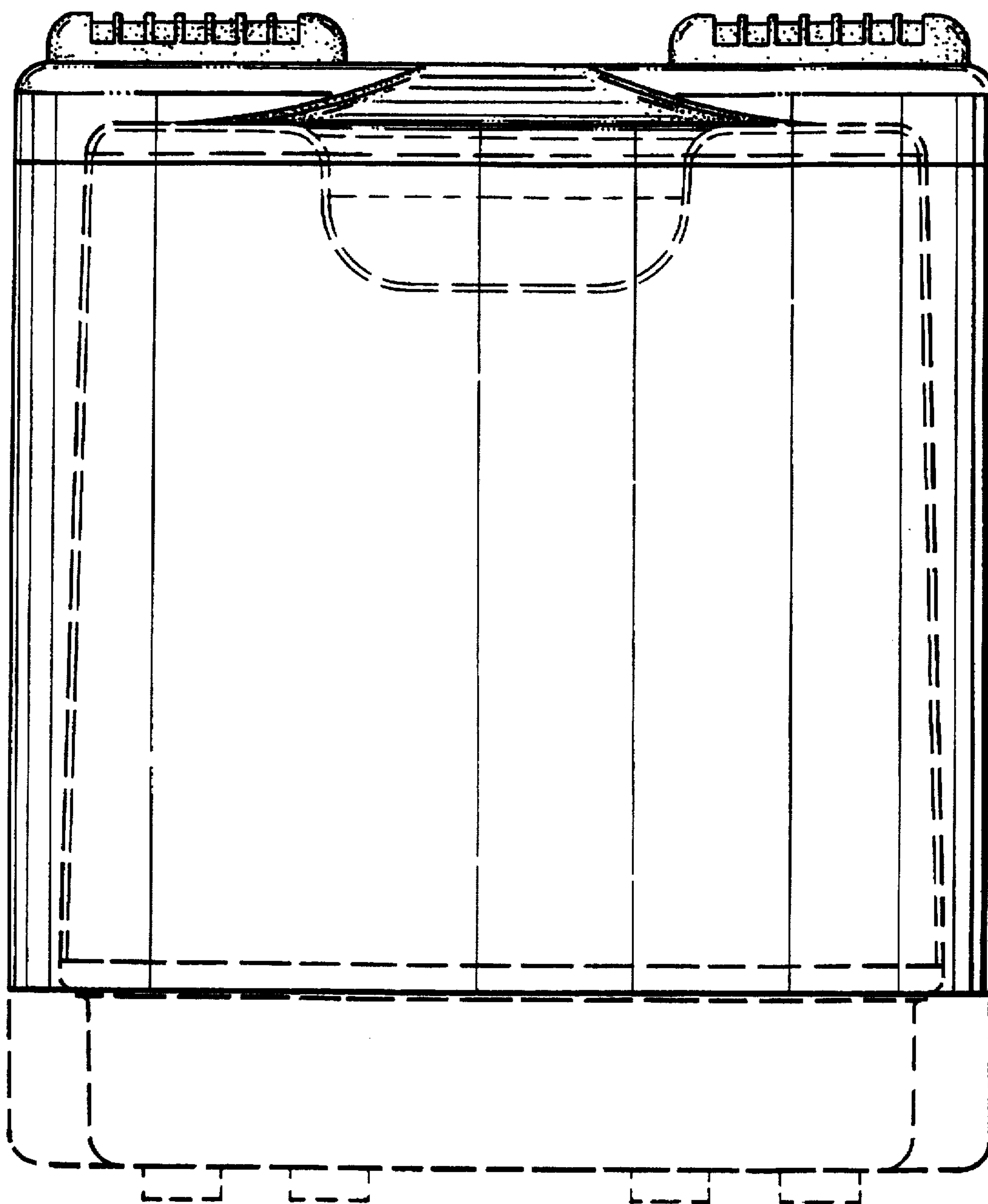

FIG. 2

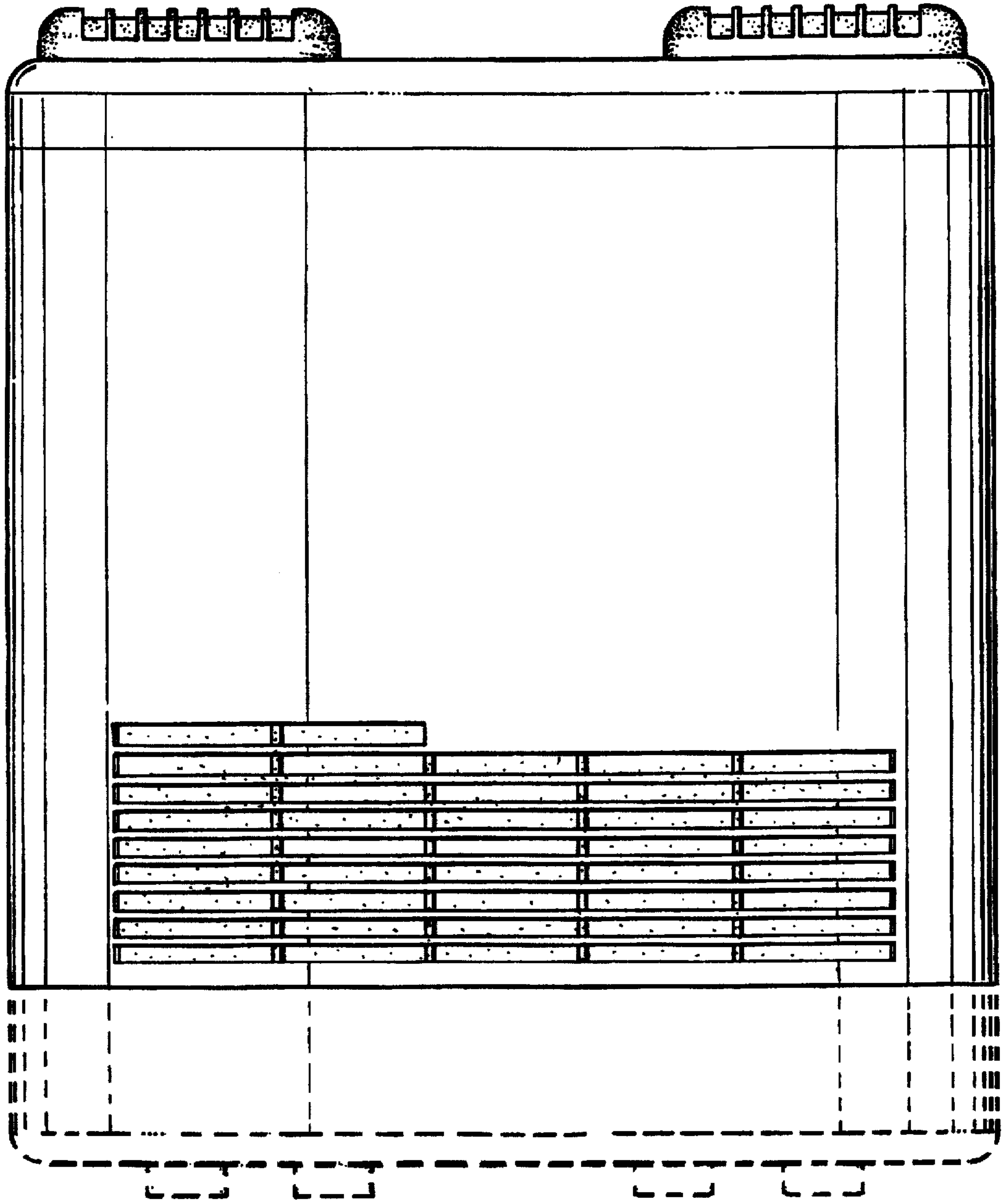

FIG. 3

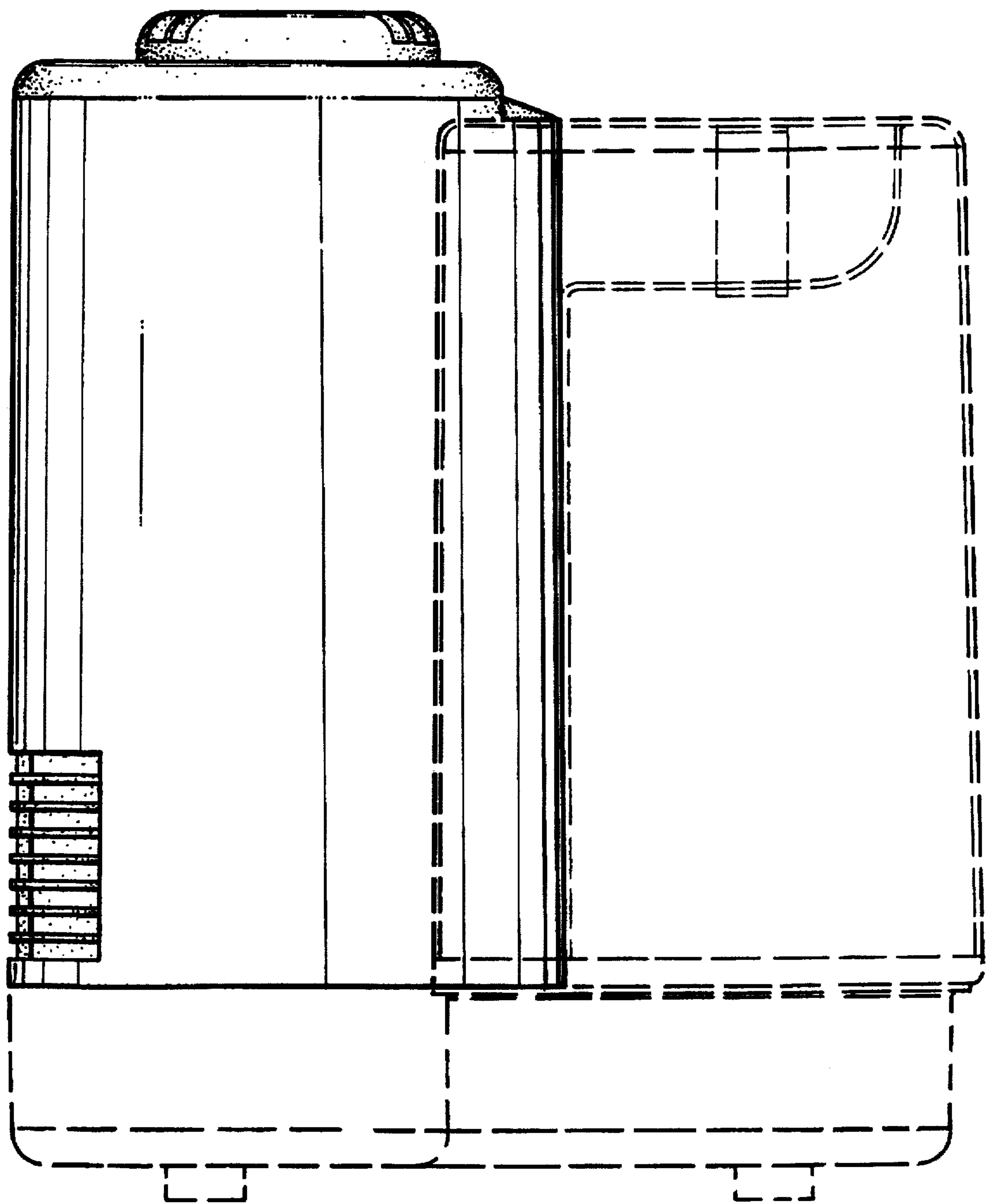

FIG. 4

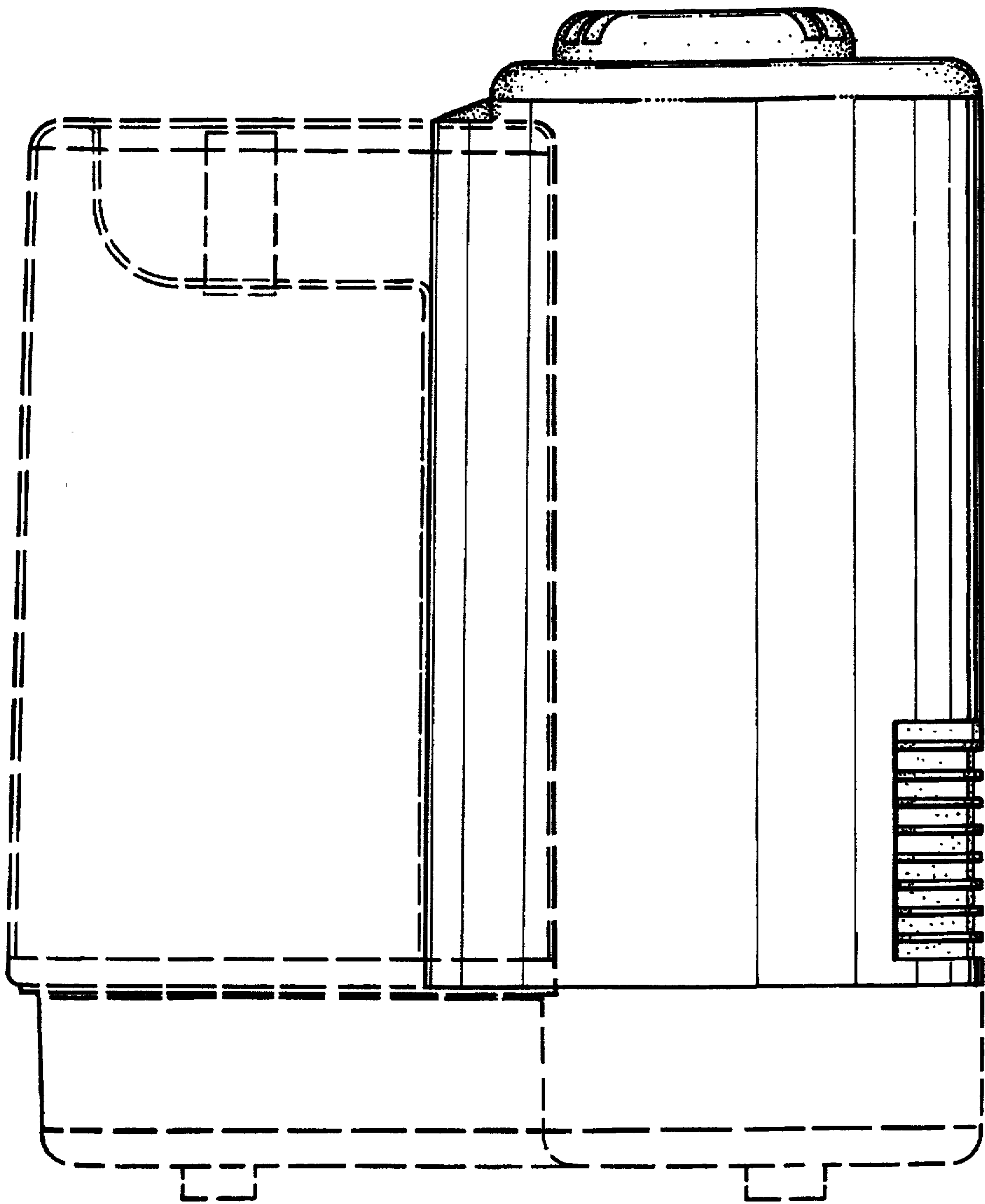

FIG. 5

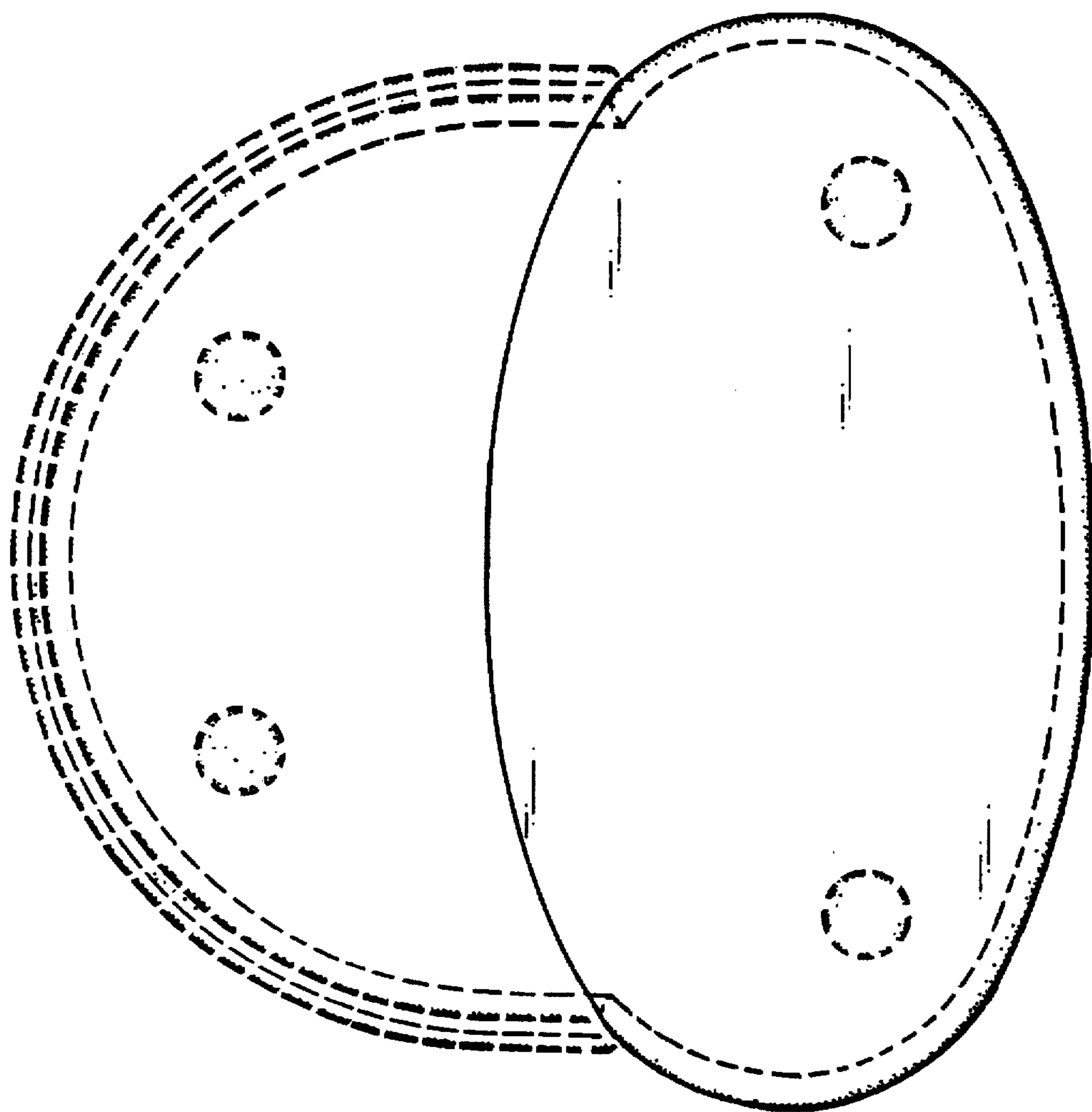

FIG. 6

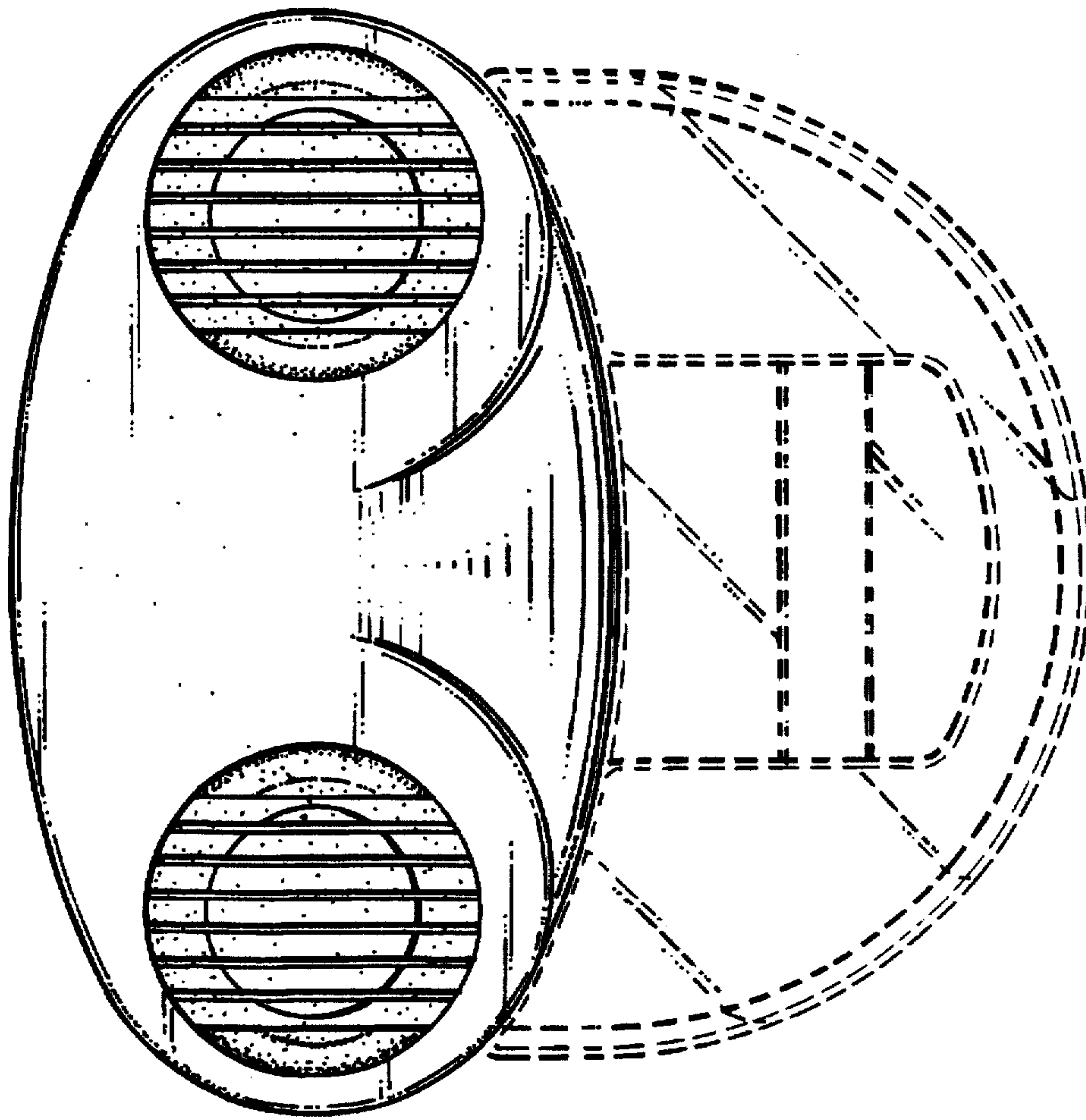

FIG. 7