



US00D388449S

# United States Patent [19]

[11] Patent Number: **Des. 388,449**

Ohi et al.

[45] Date of Patent: **\*\*Dec. 30, 1997**

[54] **ELECTRONIC STILL CAMERA**

[75] Inventors: **Hiroshi Ohi; Seiji Kurokawa**, both of Tochigi-ken, Japan

[73] Assignee: **Sharp Kabushiki Kaisha**, Osaka, Japan

[\*\*] Term: **14 Years**

[21] Appl. No.: **62,884**

[22] Filed: **Nov. 29, 1996**

[30] **Foreign Application Priority Data**

May 31, 1996	[JP]	Japan	.....	8-016048
May 31, 1996	[JP]	Japan	.....	8-016049

[51] LOC (6) Cl. .... **16-01**

[52] U.S. Cl. .... **D16/202; D16/218**

[58] Field of Search ..... **D16/200-205, D16/208, 209, 216-218; 348/375-376; 396/535-543; 358/906, 909.1**

[56] **References Cited**

**U.S. PATENT DOCUMENTS**

D. 361,079	8/1995	Ono	.....	D16/202
D. 363,731	10/1995	Alden et al.	.....	D16/202
D. 369,818	5/1996	Ono	.....	D16/202
D. 371,377	7/1996	Miyahara	.....	D16/202
4,943,822	7/1990	Von Braunhut	.....	396/535

Primary Examiner—Philip S. Hyder

Assistant Examiner—Adir Aronovich  
Attorney, Agent, or Firm—Nixon & Vanderhye

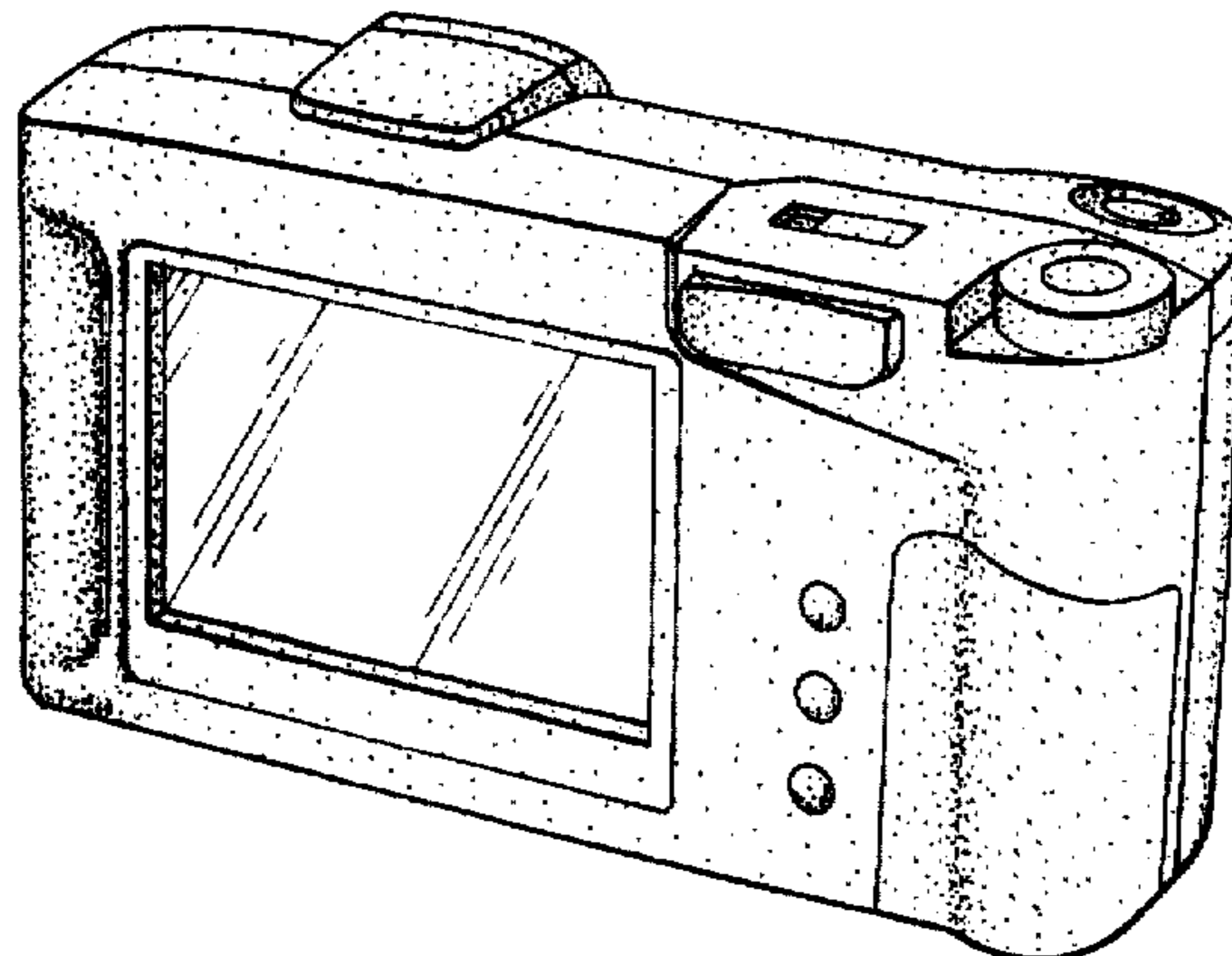
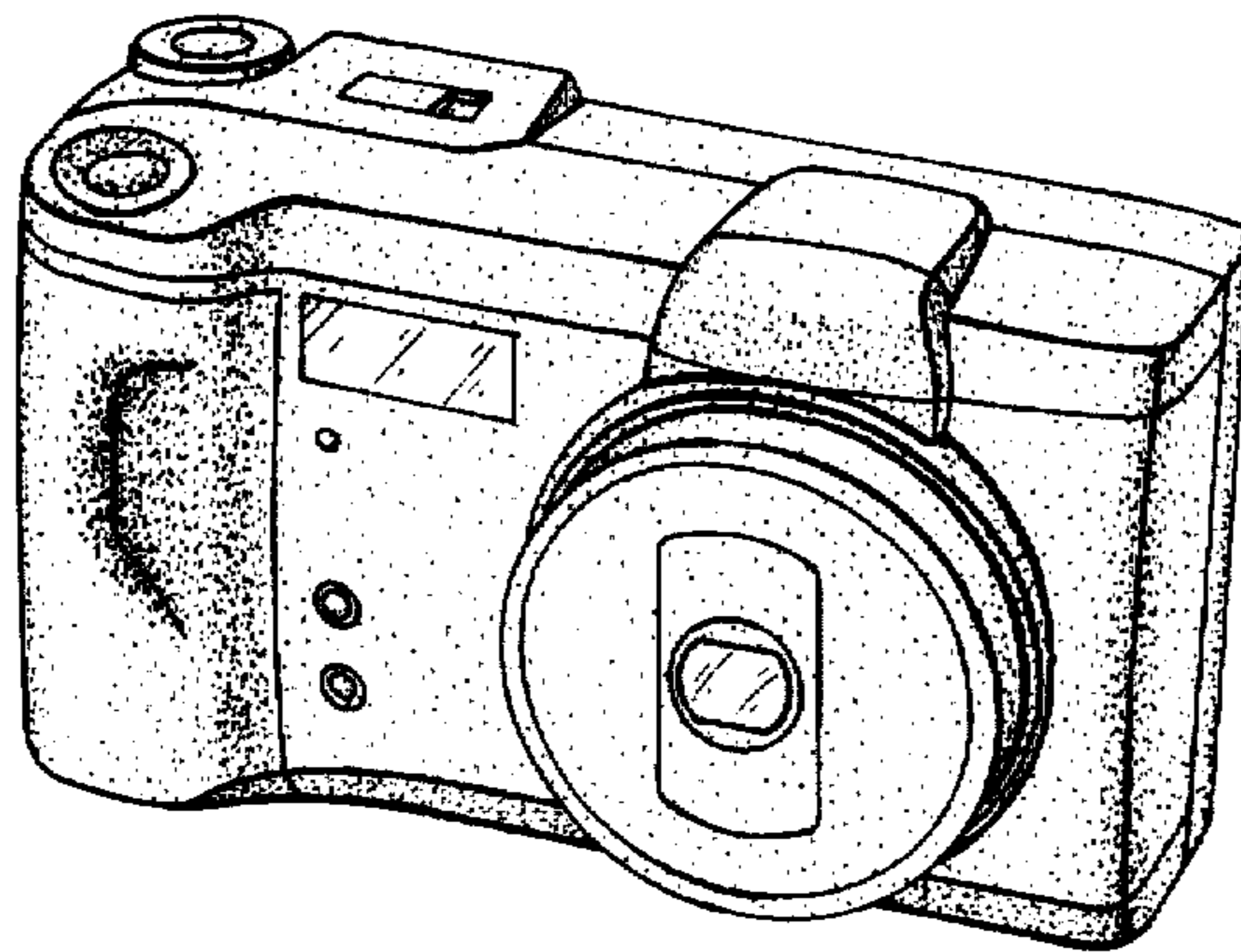
[57] **CLAIM**

The ornamental design for an electronic still camera, as shown and described.

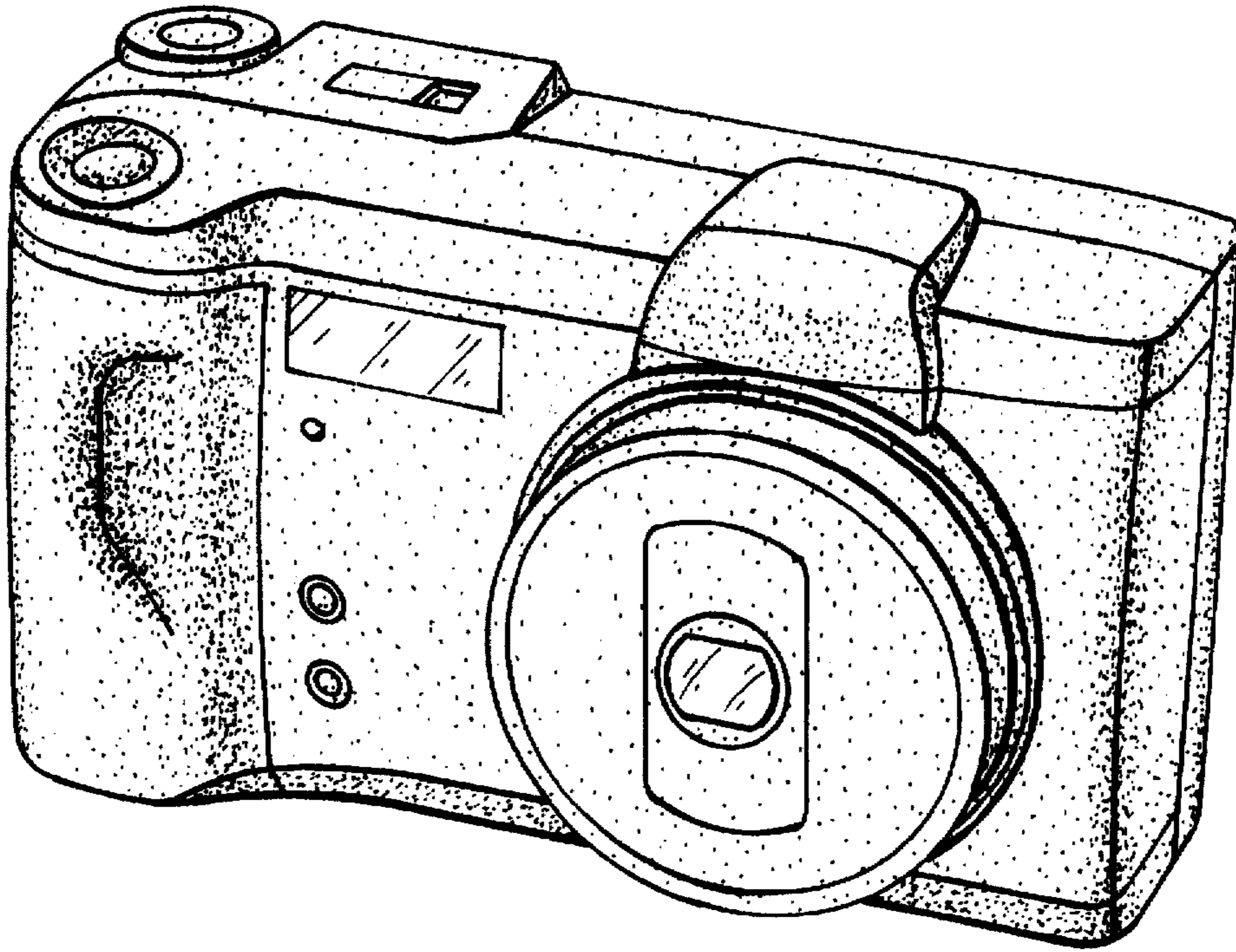
**DESCRIPTION**

FIG. 1 is a top, front and right side perspective view of an electronic still camera according to our design;  
 FIG. 2 is a top, rear and left side perspective view thereof;  
 FIG. 3 is a top plan view thereof;  
 FIG. 4 is a front elevational view thereof;  
 FIG. 5 is a right side elevational view thereof;  
 FIG. 6 is a rear elevational view thereof;  
 FIG. 7 is a left side elevational view thereof;  
 FIG. 8 is a bottom plan view thereof;  
 FIG. 9 is a top, front and left side perspective view of another embodiment of an electronic still camera according to our design;  
 FIG. 10 is a top, rear and right side perspective view of an electronic still camera according to our design;  
 FIG. 11 is a top plan view thereof;  
 FIG. 12 is a front elevational view thereof;  
 FIG. 13 is a left side elevational view thereof;  
 FIG. 14 is a rear elevational view thereof;  
 FIG. 15 is a right side elevational view thereof; and,  
 FIG. 16 is a bottom plan view thereof.

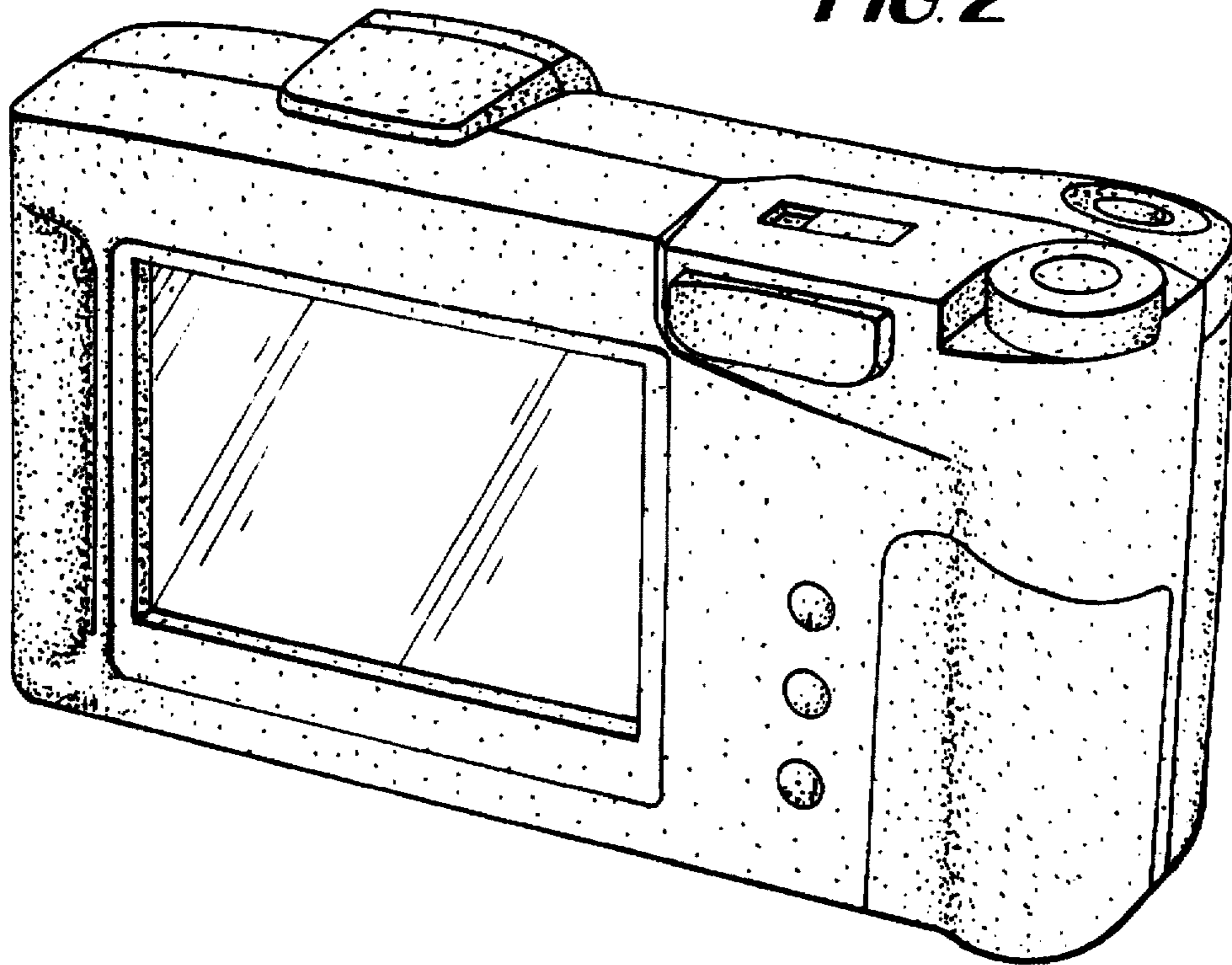
**1 Claim, 8 Drawing Sheets**

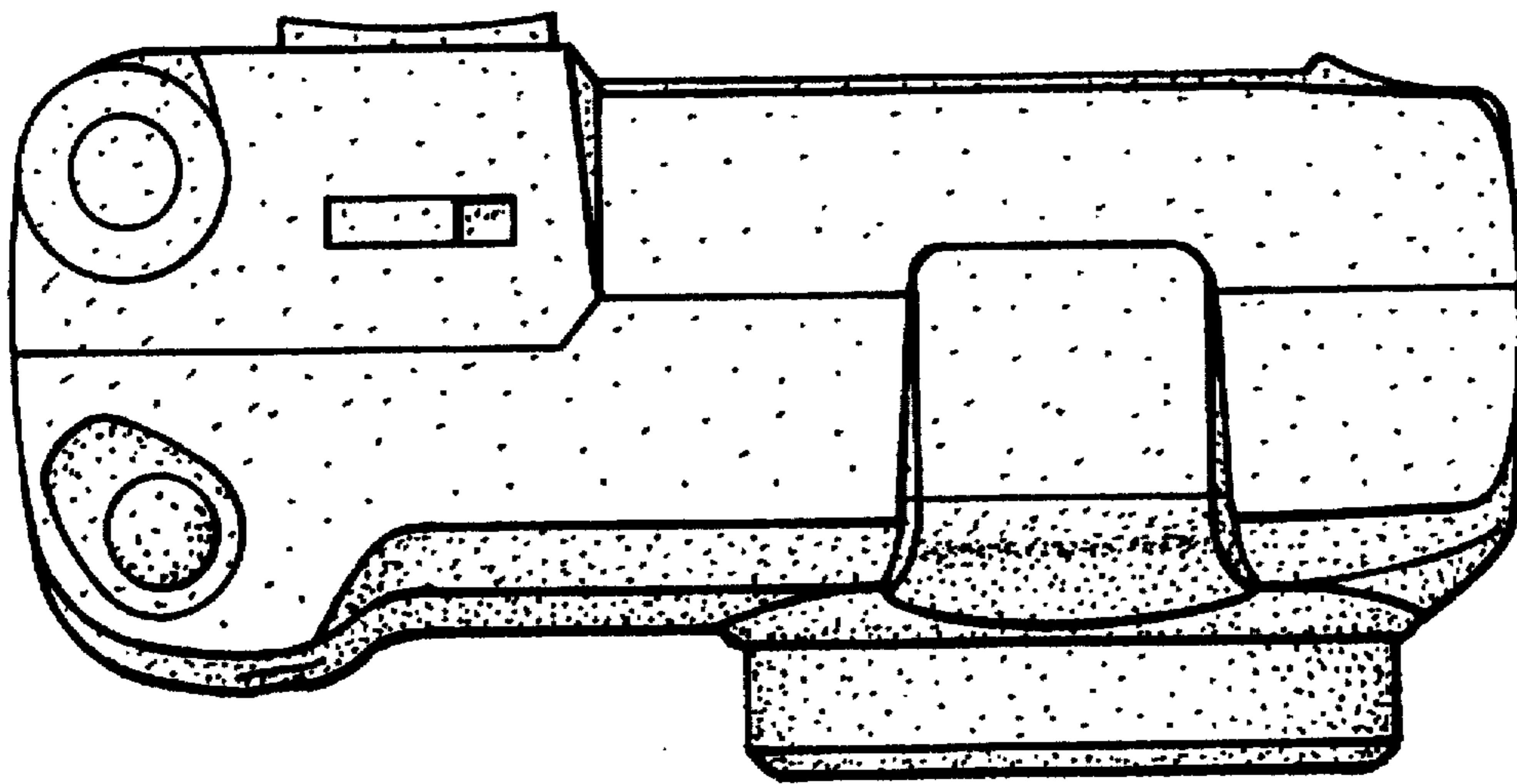


**FIG. 1**



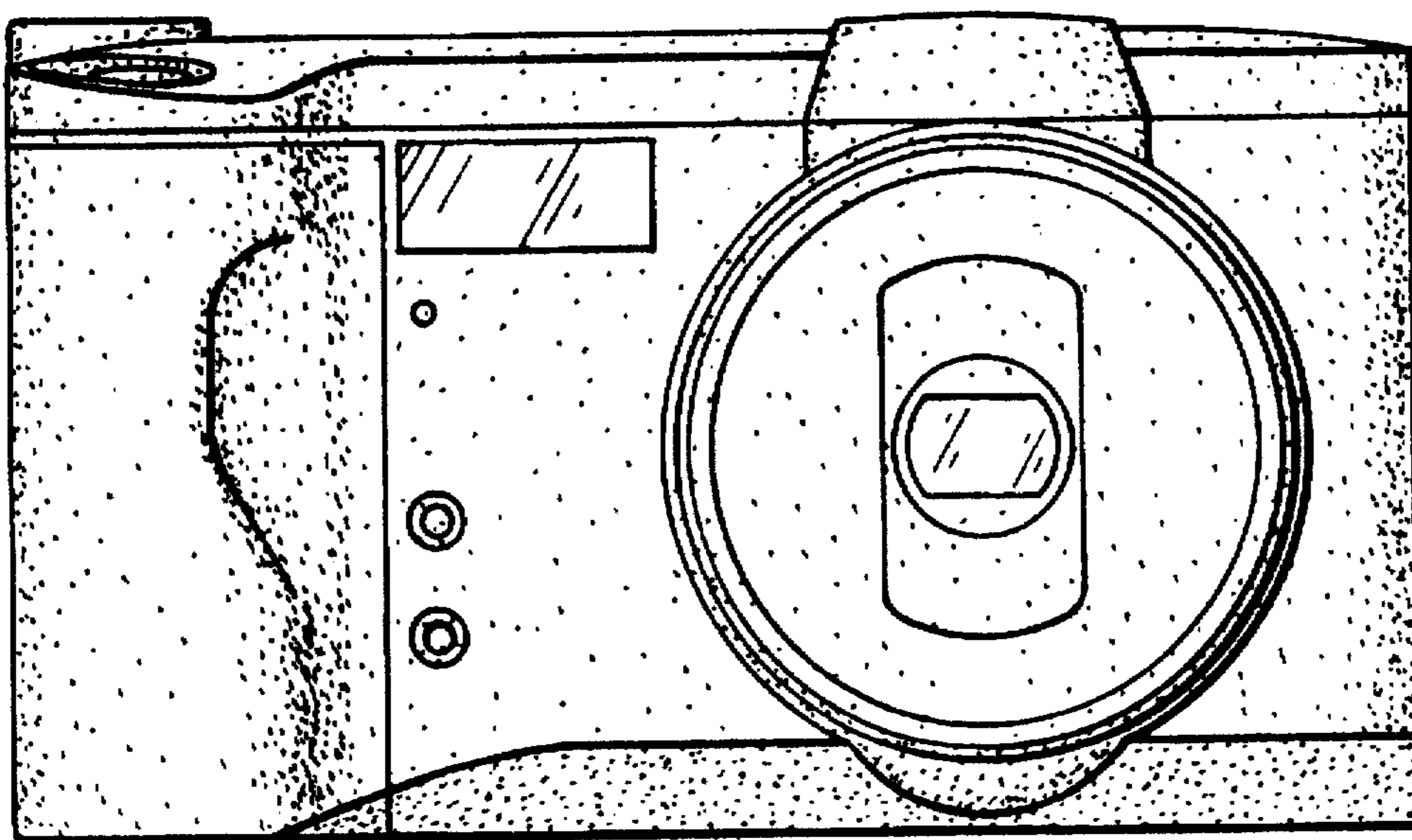
**FIG. 2**

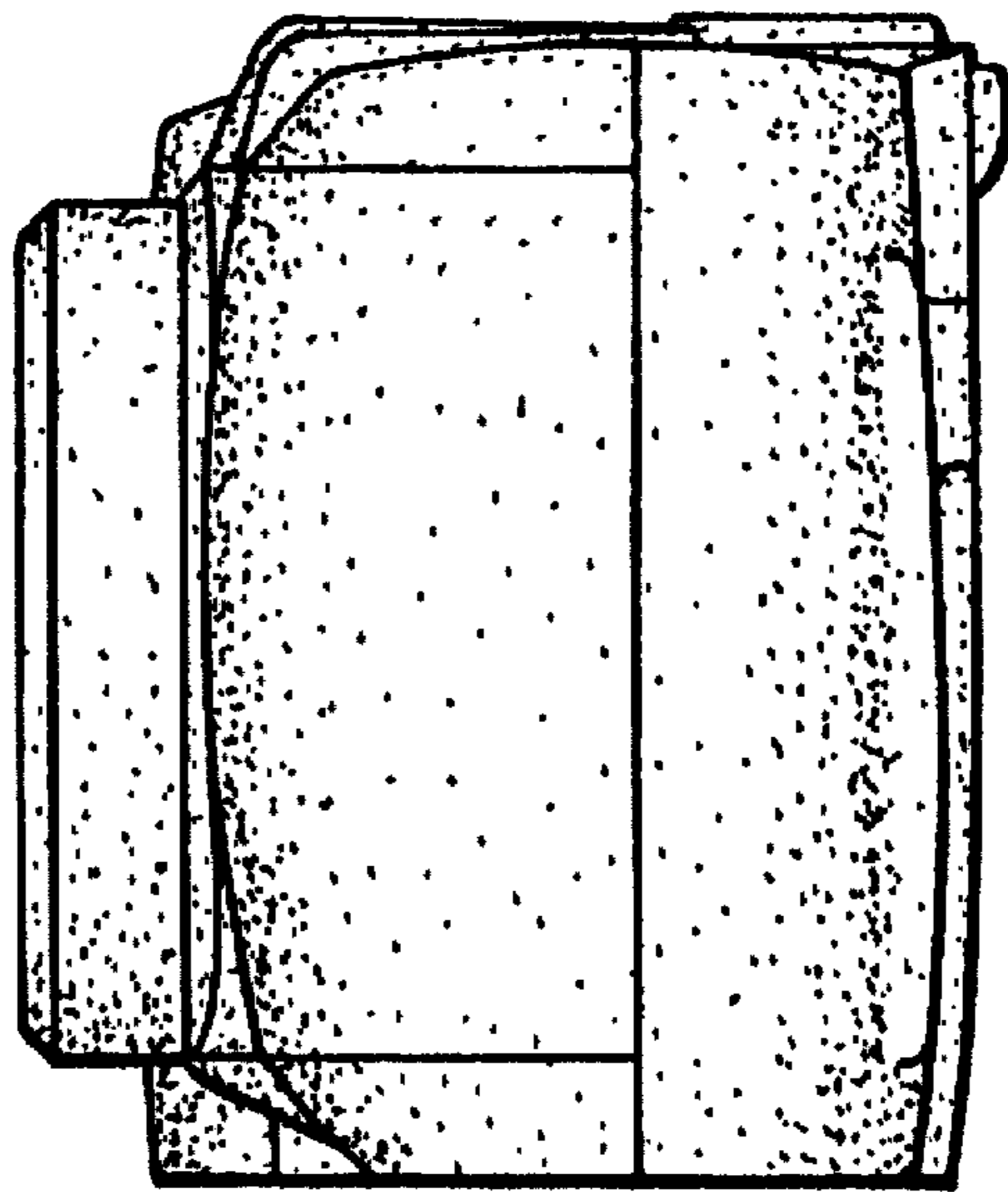




**FIG. 3**

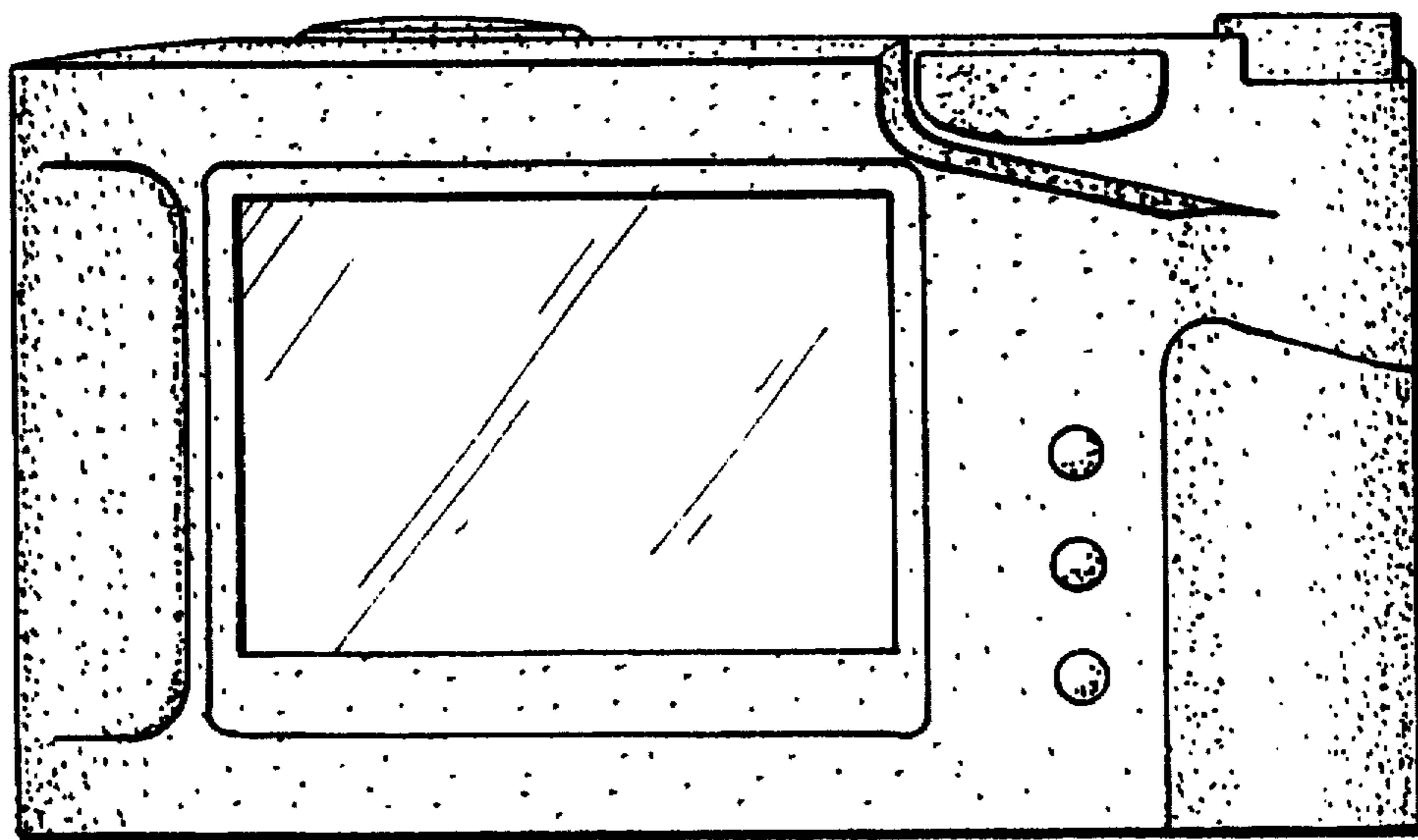
**FIG. 4**

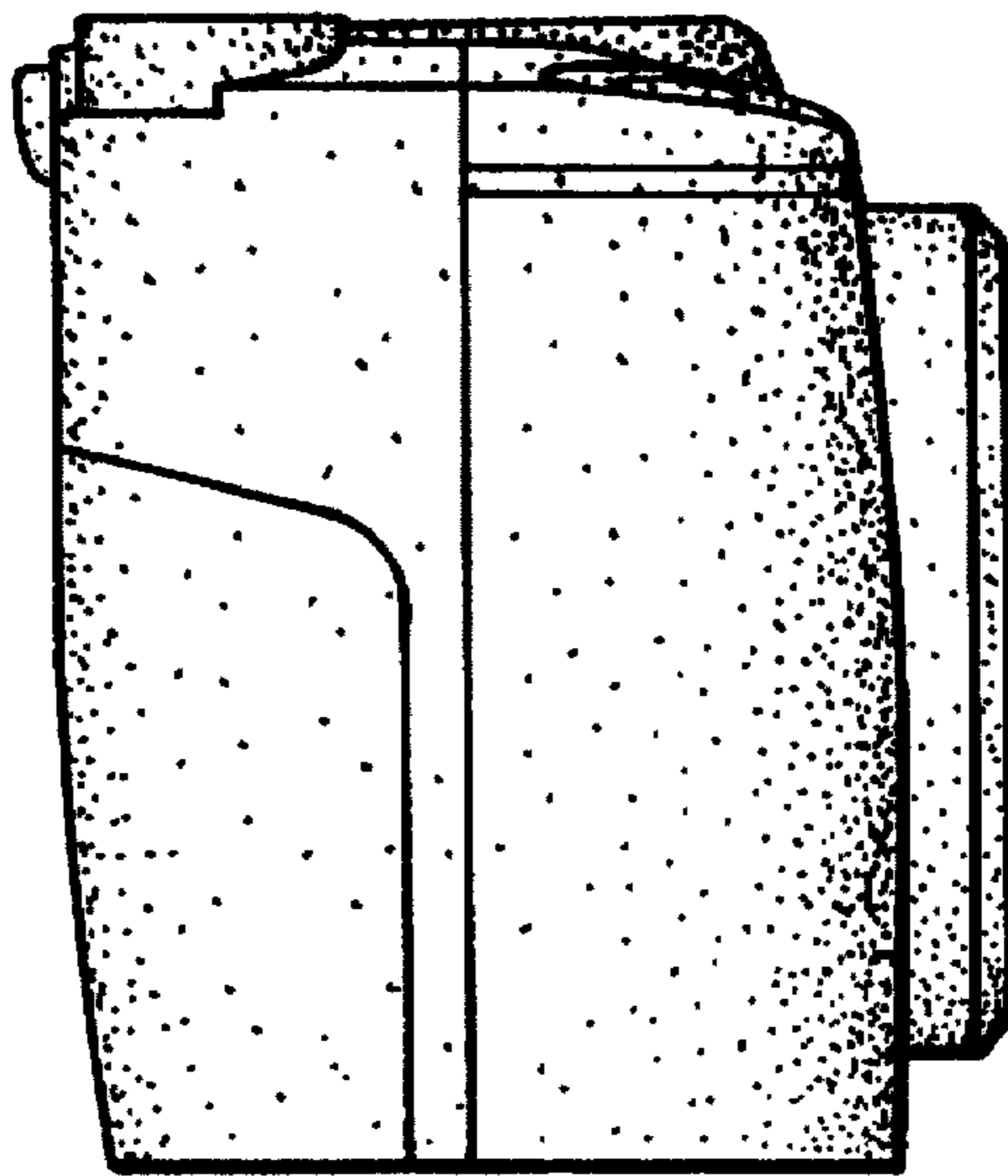




**FIG. 5**

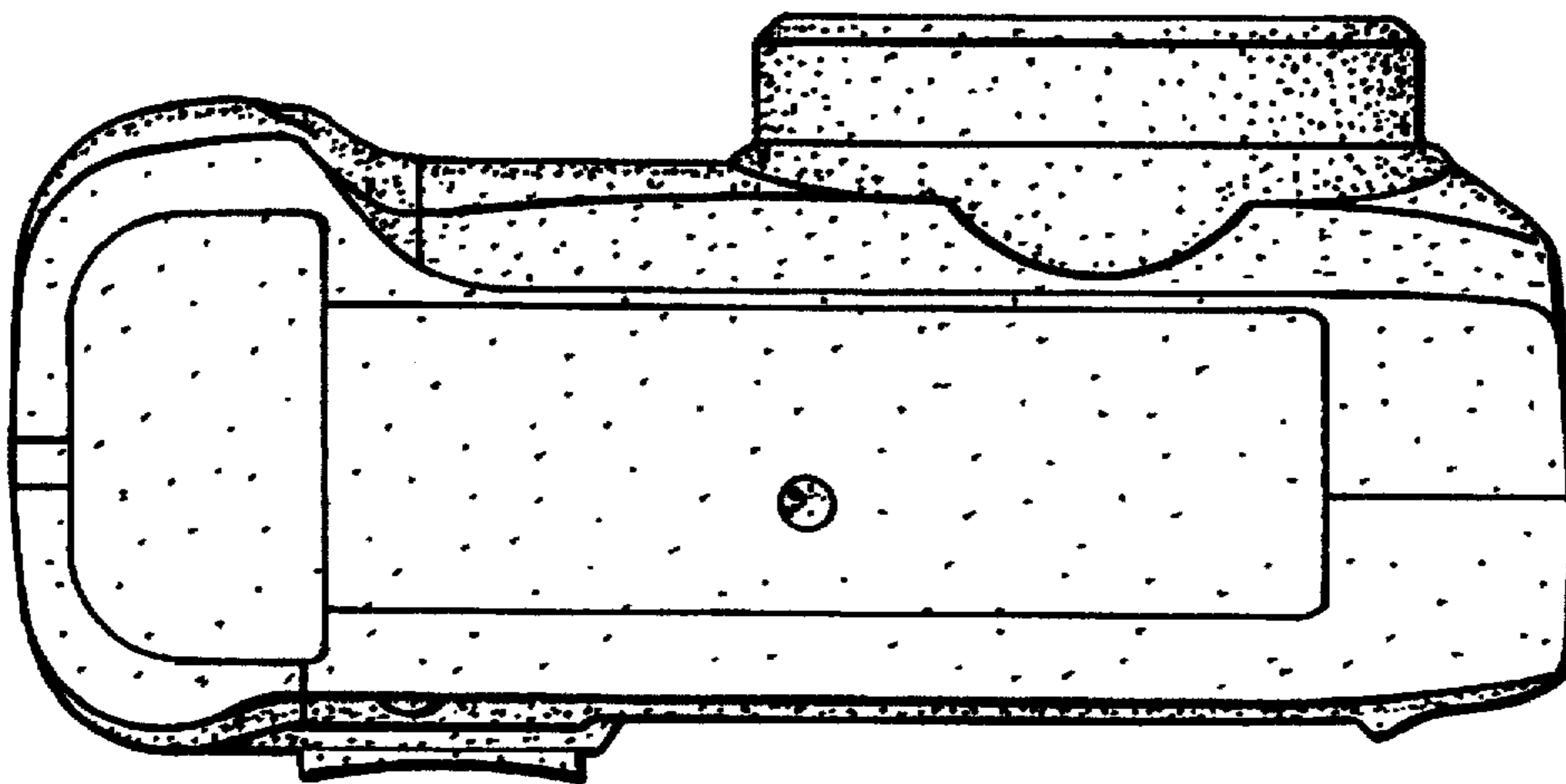
**FIG. 6**



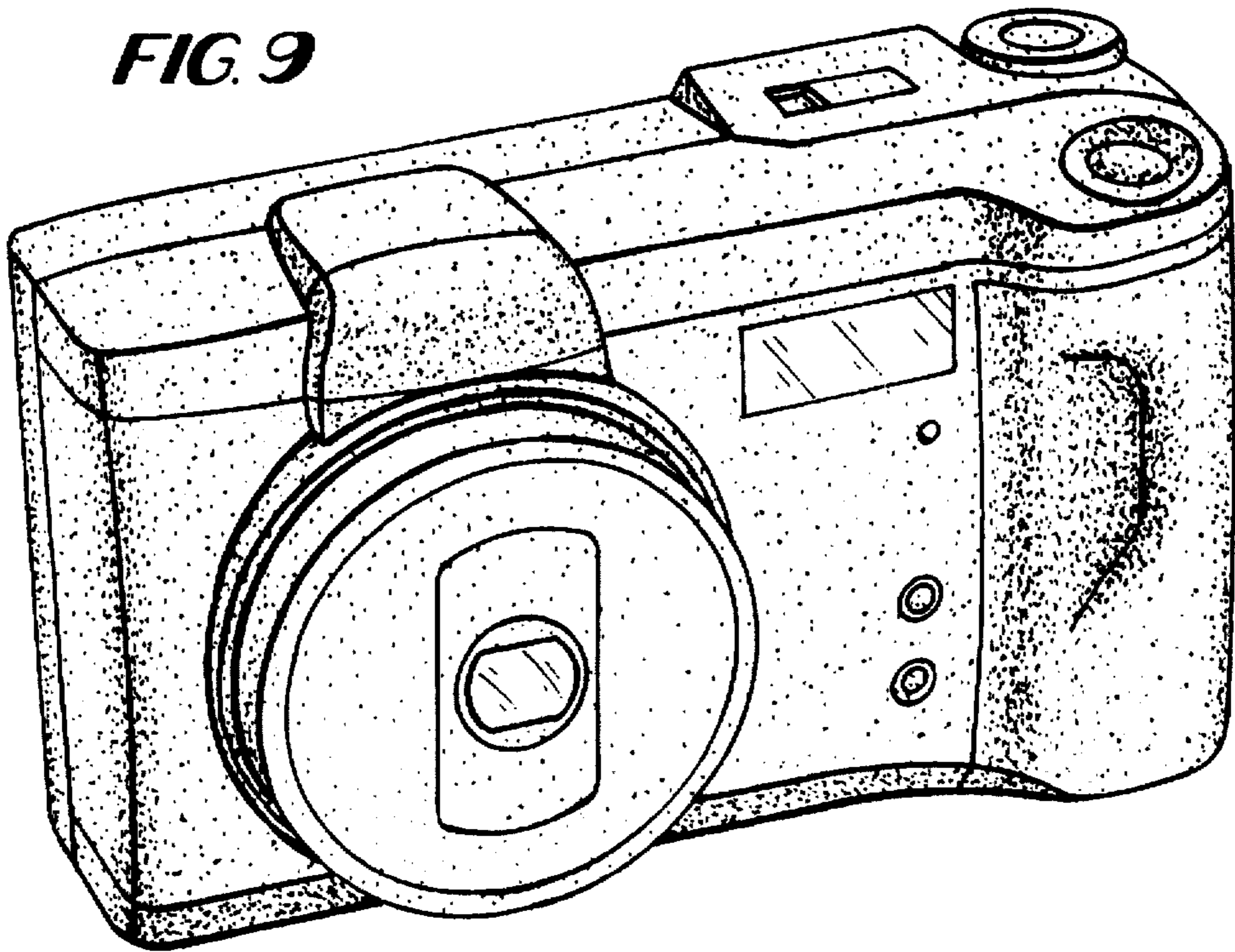


**FIG. 7**

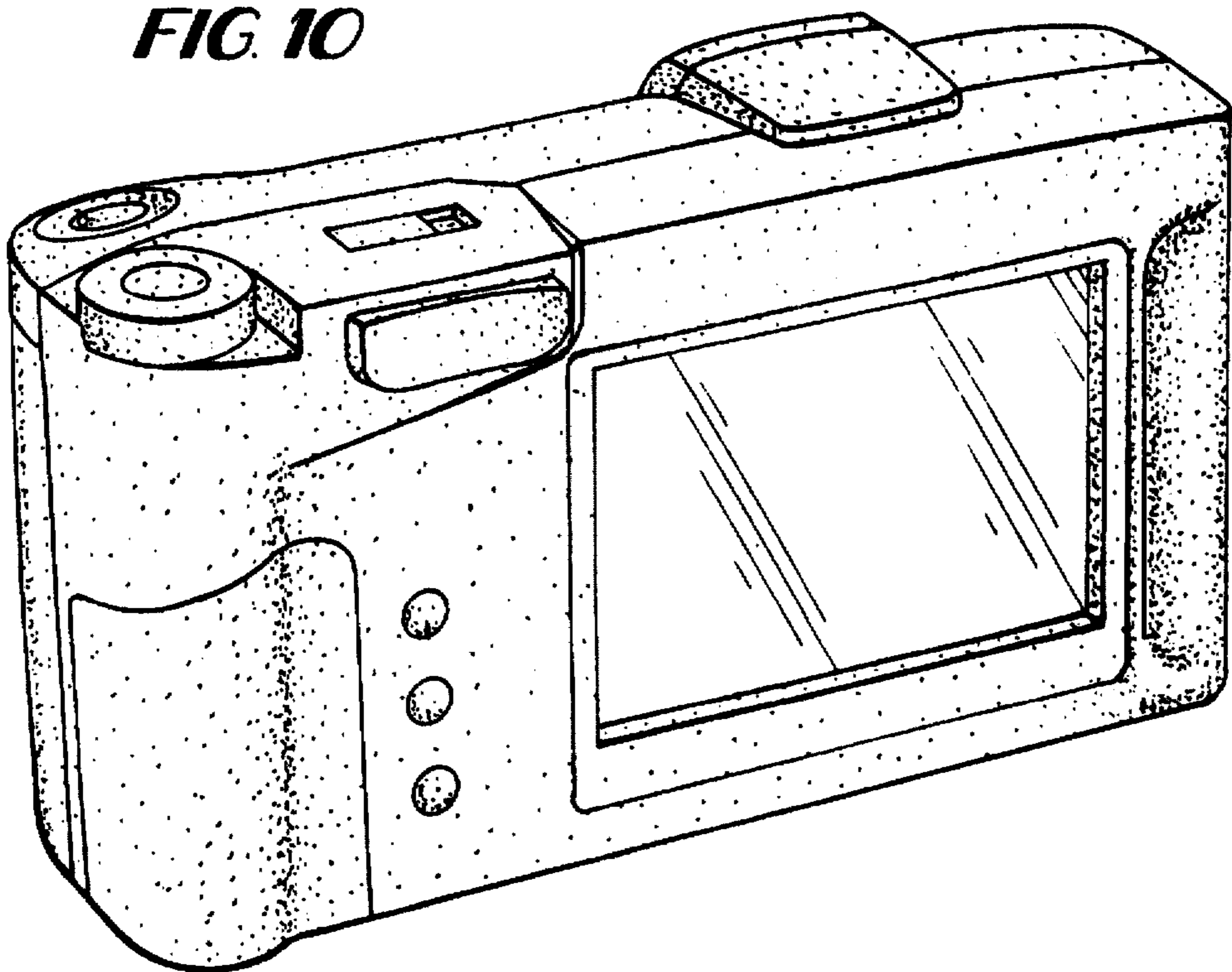
**FIG. 8**

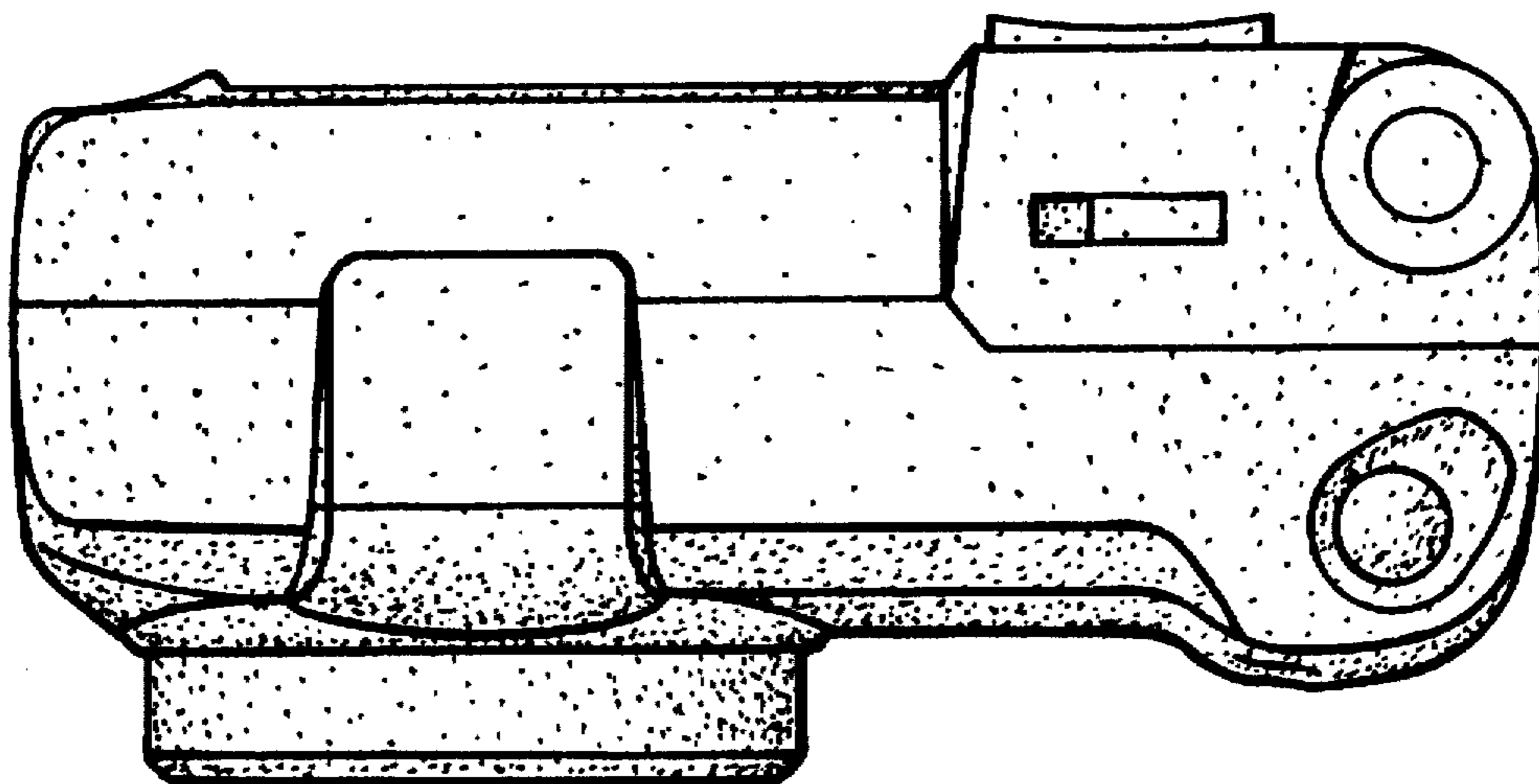


**FIG. 9**



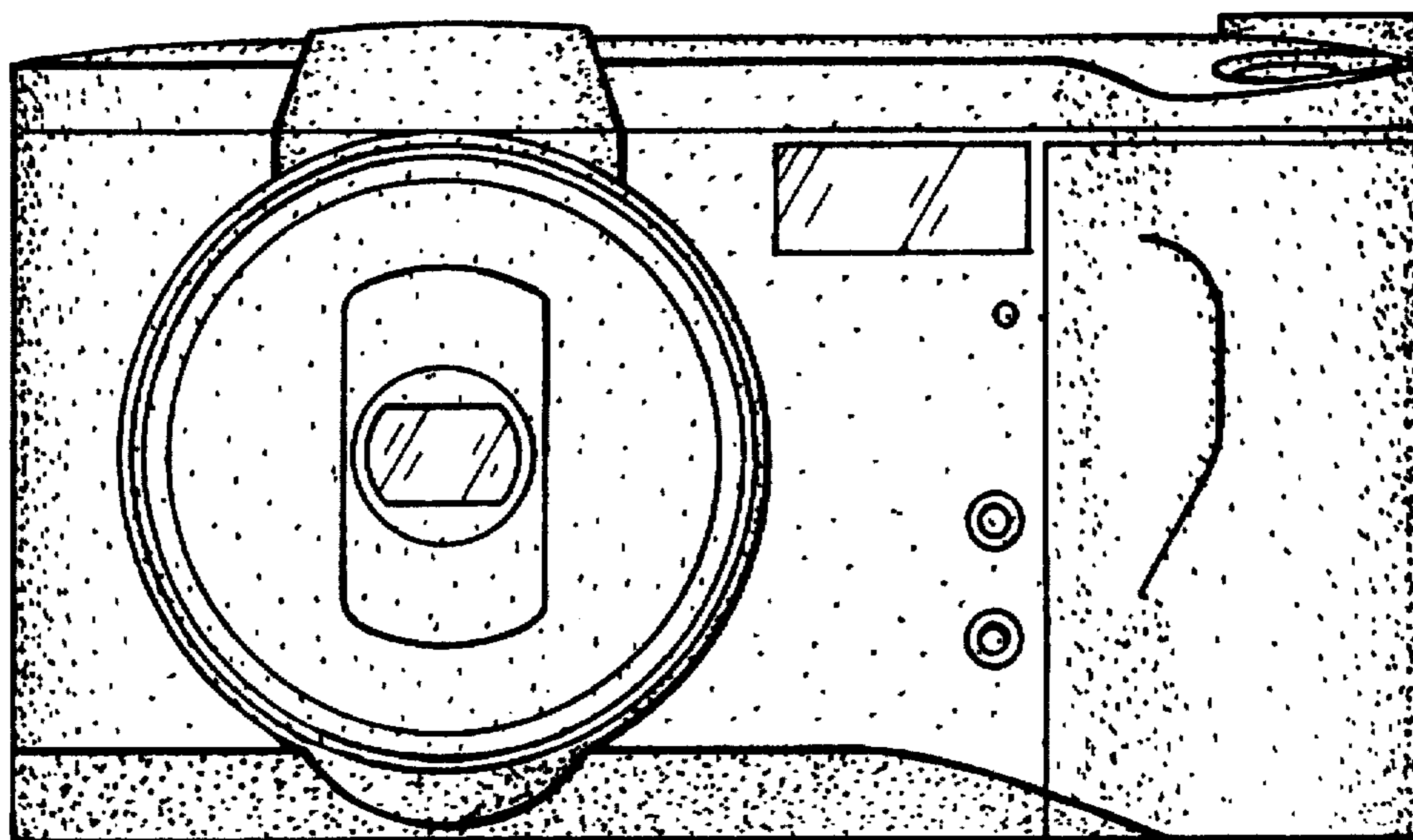
**FIG. 10**

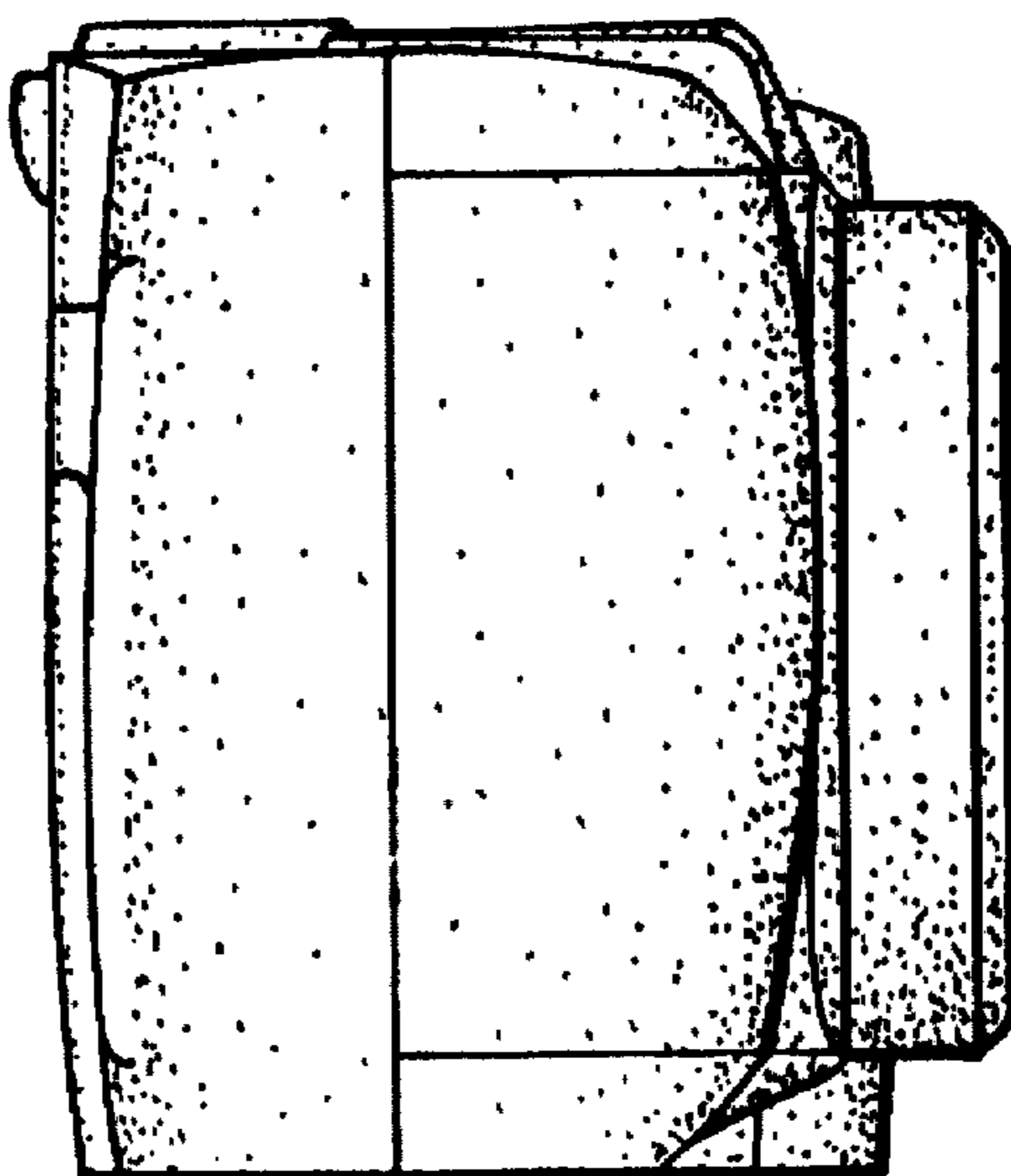




**FIG. 11**

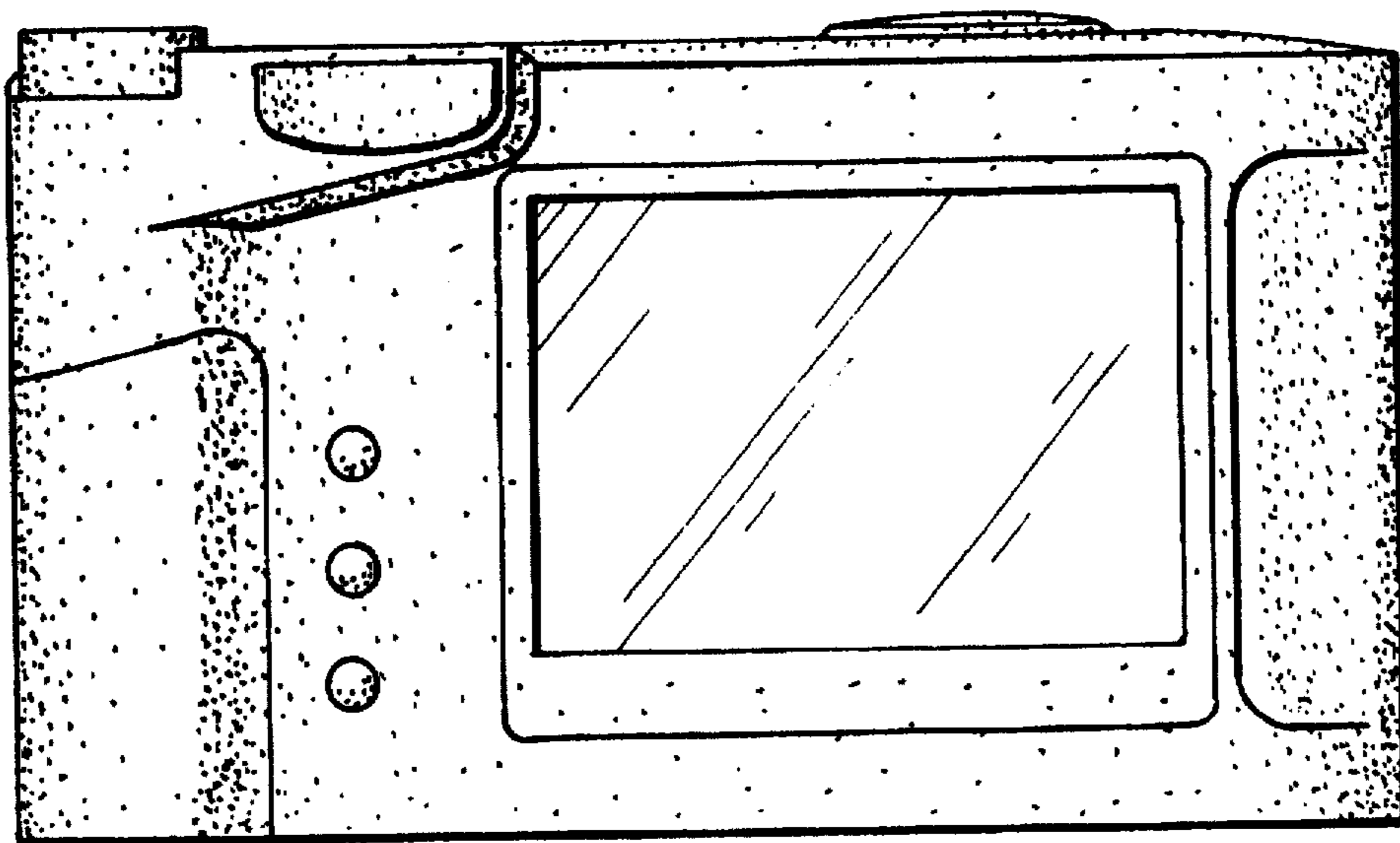
**FIG. 12**



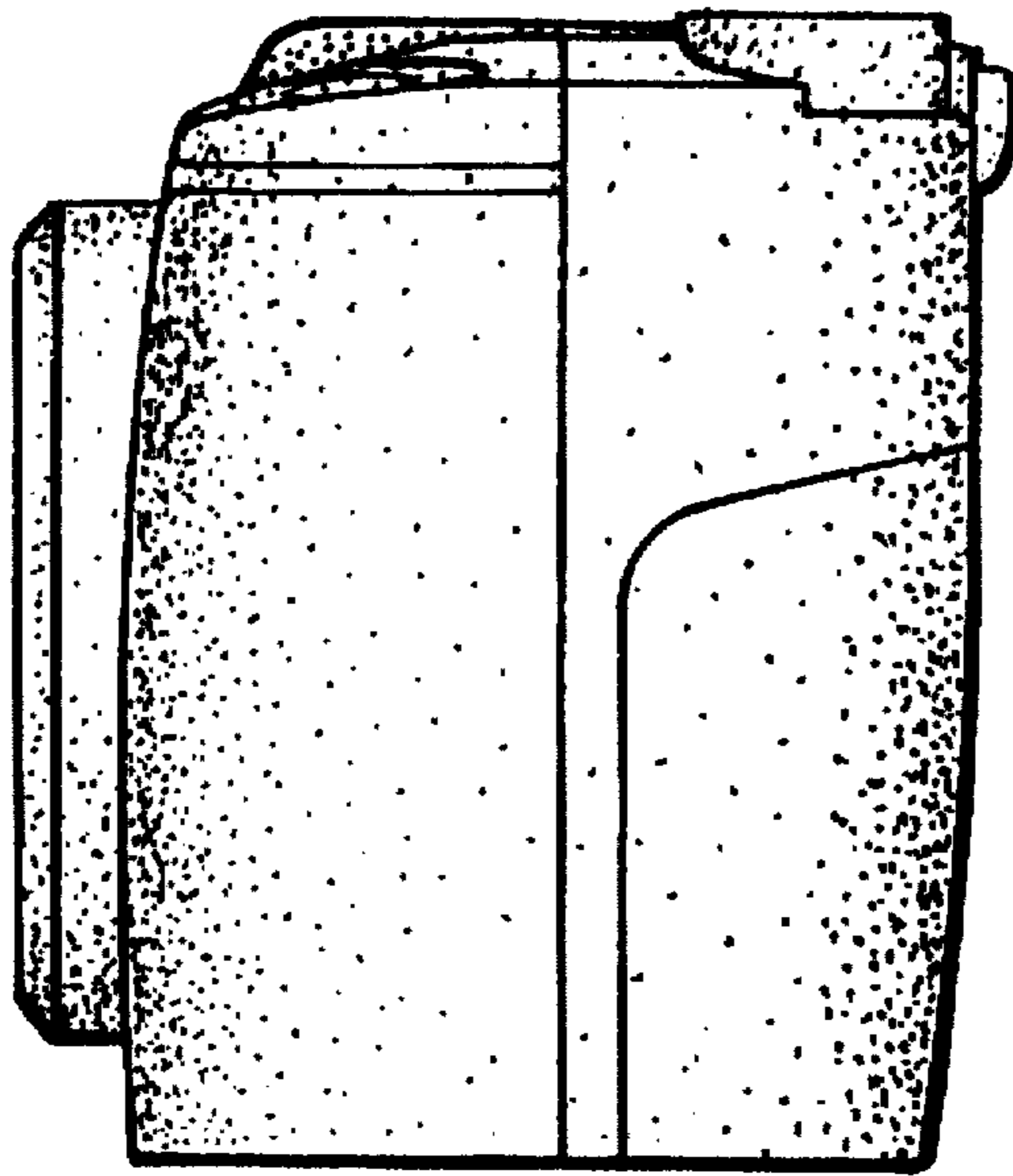


**FIG. 13**

**FIG. 14**







**FIG. 15**

**FIG. 16**

