



US00D388400S

United States Patent [19] Rogers

[11] Patent Number: **Des. 388,400**
[45] Date of Patent: ****Dec. 30, 1997**

[54] **CABLE MANAGEMENT RACK**
[75] Inventor: **Joseph W. Rogers, Monticello, Ind.**
[73] Assignee: **Precision Fabrication Technologies, Inc., Monon, Ind.**
[**] Term: **14 Years**
[21] Appl. No.: **49,658**
[22] Filed: **Jan. 26, 1996**
[51] LOC (6) Cl. **13-99**
[52] U.S. Cl. **D13/199**
[58] Field of Search **D13/155, 199;**
D6/567, 569-571; D14/240; 361/826, 827,
829; 211/26, 191-193, 201, 204; 379/327,
328

[56] **References Cited**
U.S. PATENT DOCUMENTS
4,470,102 9/1984 De Luca et al. 361/826
4,497,411 2/1985 DeBortoli 211/26
4,665,546 5/1987 Brey et al. 379/327
4,759,057 7/1988 De Luca et al. 379/327
4,904,211 2/1990 Meyerhoefer et al. 361/826 X

Primary Examiner—Alan P. Douglas
Assistant Examiner—Lavone D. Tabor

Attorney, Agent, or Firm—Woodard, Emhardt, Naughton Moriarty & McNett

[57] **CLAIM**
The ornamental design for a cable management rack, as shown and described.

DESCRIPTION
FIG. 1 is a perspective view of the preferred embodiment of the rack incorporating my new design;
FIG. 2 is a rear view of the rack of FIG. 1;
FIG. 3 is a right side view with the left side view being a mirror image thereof;
FIG. 4 is a front view;
FIG. 5 is a top view;
FIG. 6 is a bottom view;
FIG. 7 is an exploded view of FIG. 1;
FIG. 8 is a perspective view of an alternate embodiment of the rack;
FIG. 9 is a rear view of the rack of FIG. 8;
FIG. 10 is a right side view of the rack of FIG. 9 with the opposite side being a mirror image thereof;
FIG. 11 is a front view of the rack of FIG. 8;
FIG. 12 is a top view of the rack of FIG. 8;
FIG. 13 is a bottom view of the rack of FIG. 8; and,
FIG. 14 is an exploded view of FIG. 8.

1 Claim, 10 Drawing Sheets

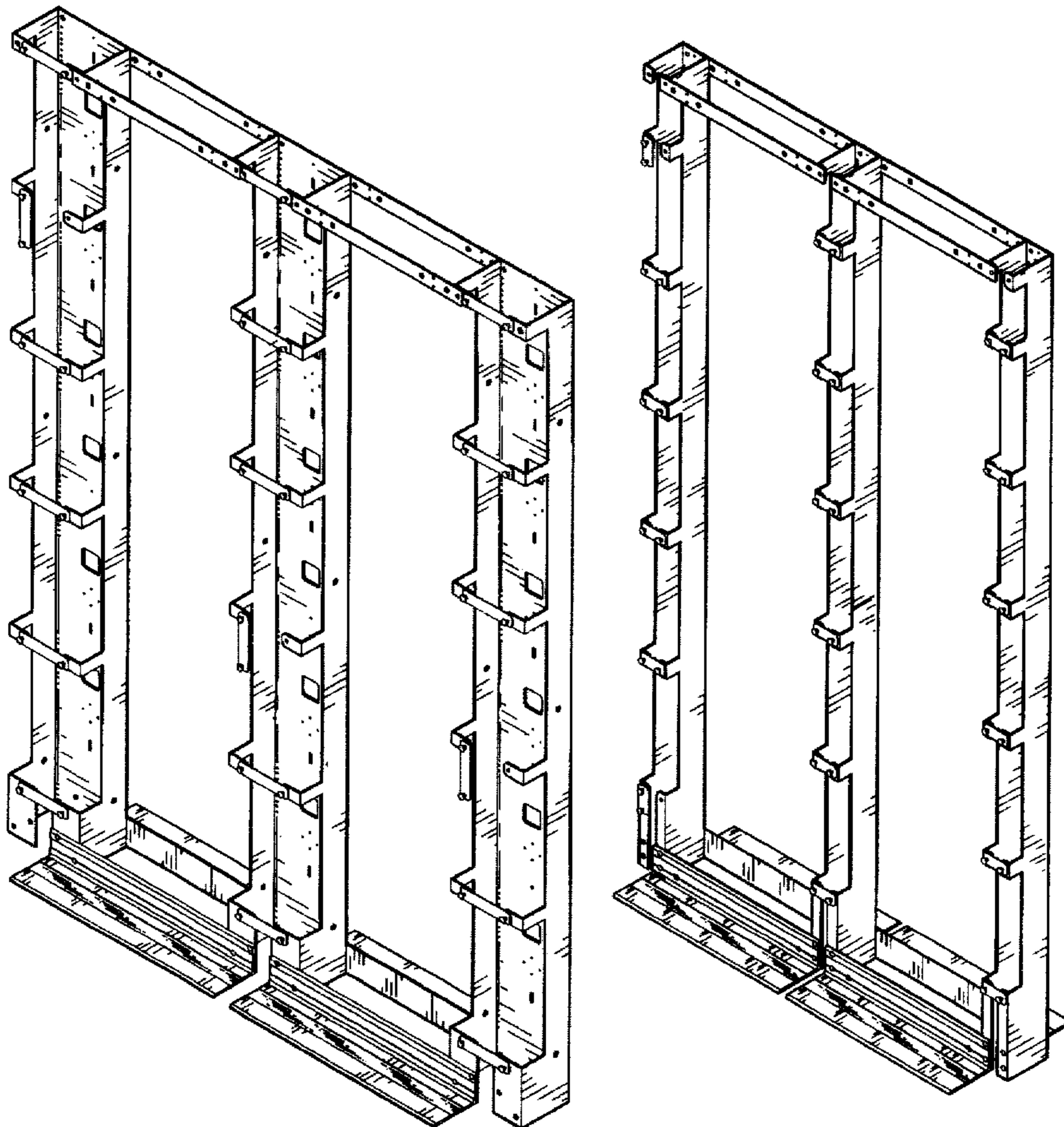

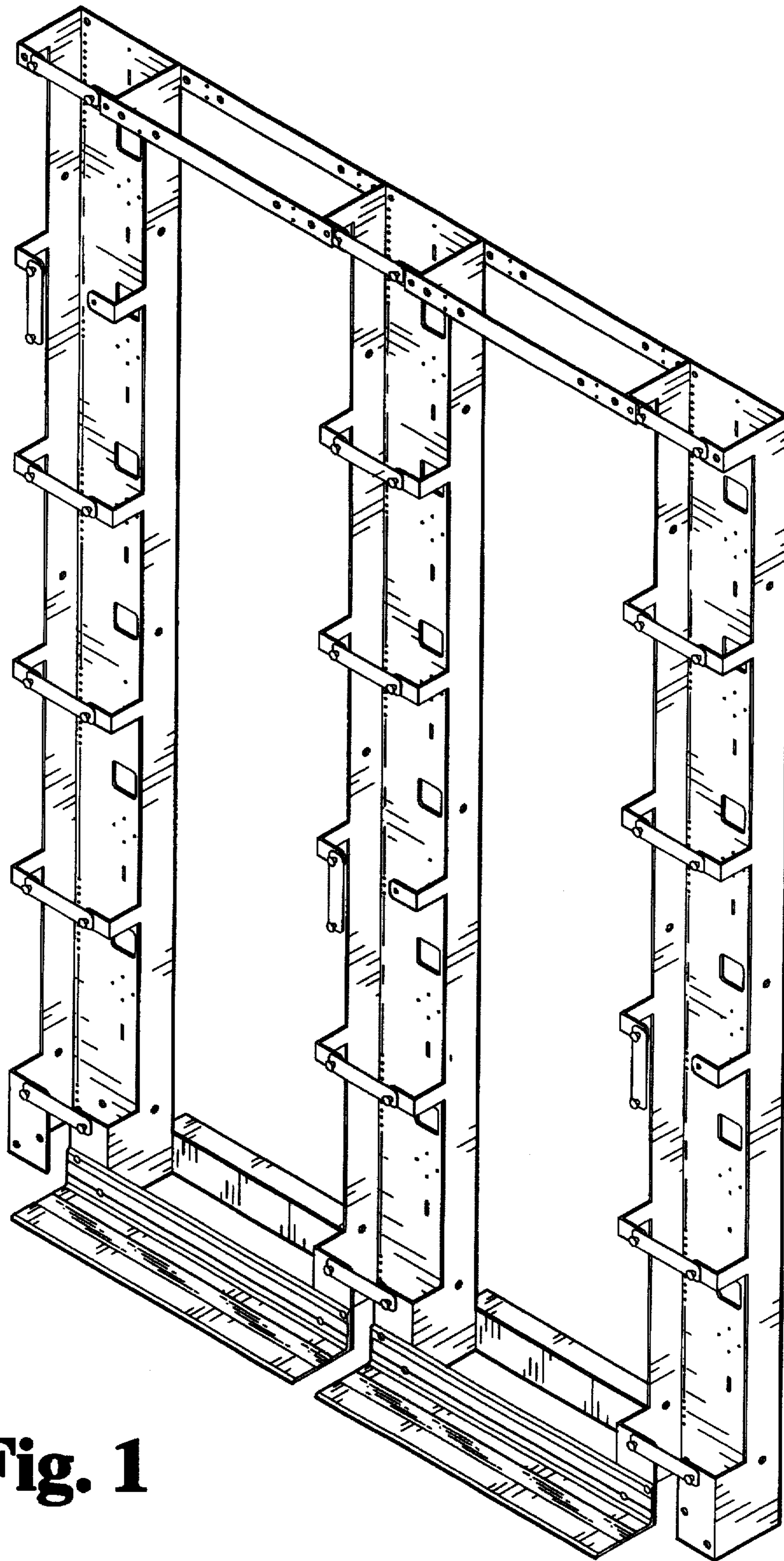

Fig. 1

Fig. 3

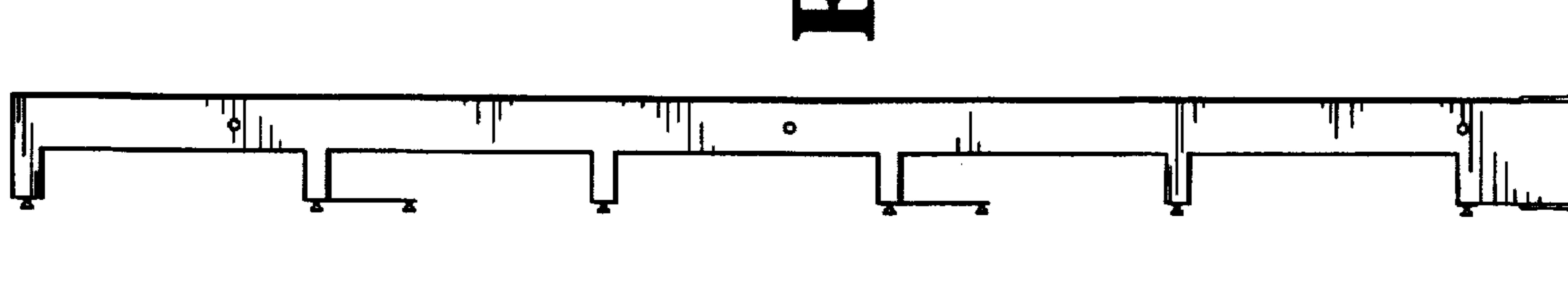
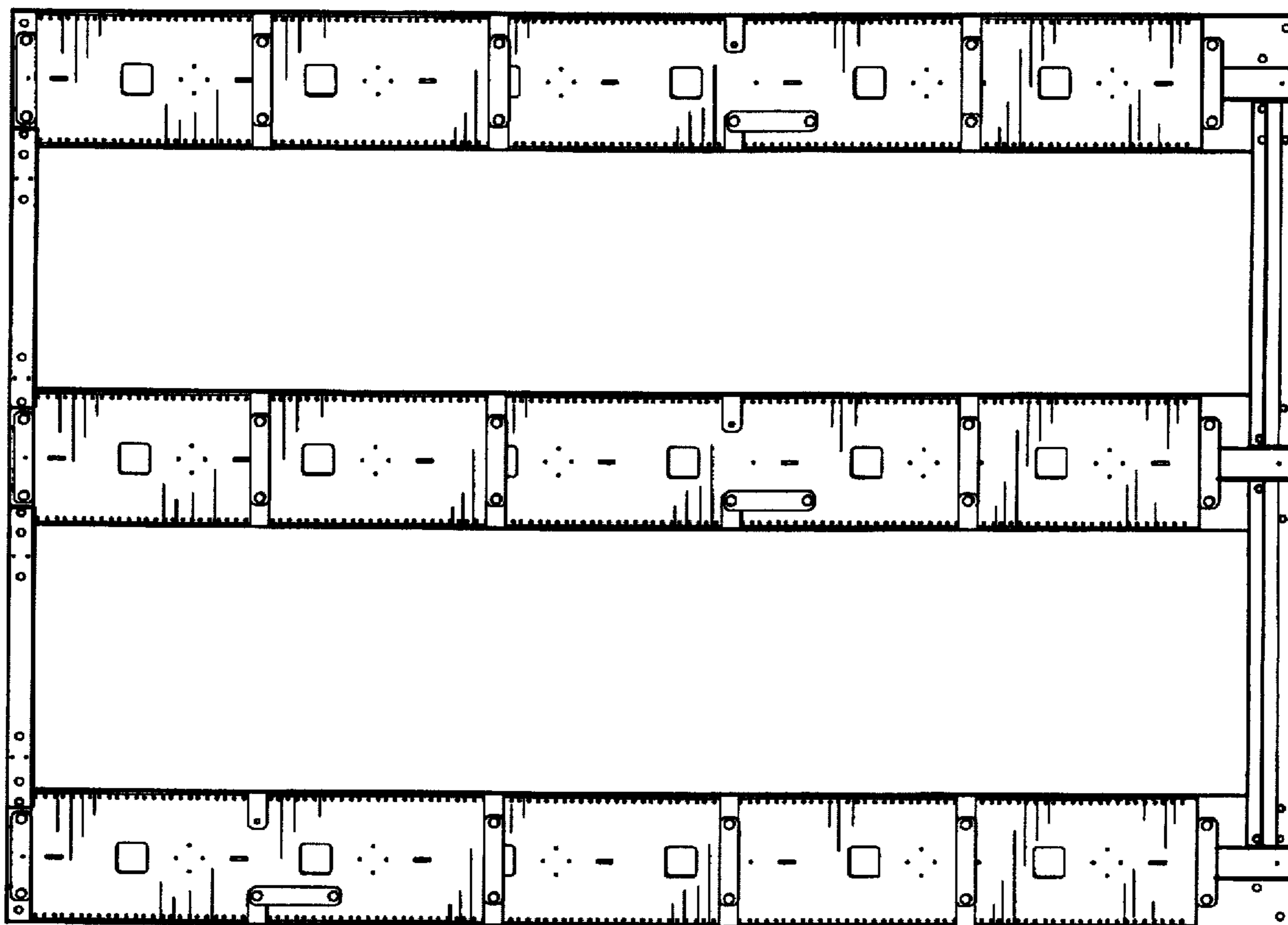

Fig. 2



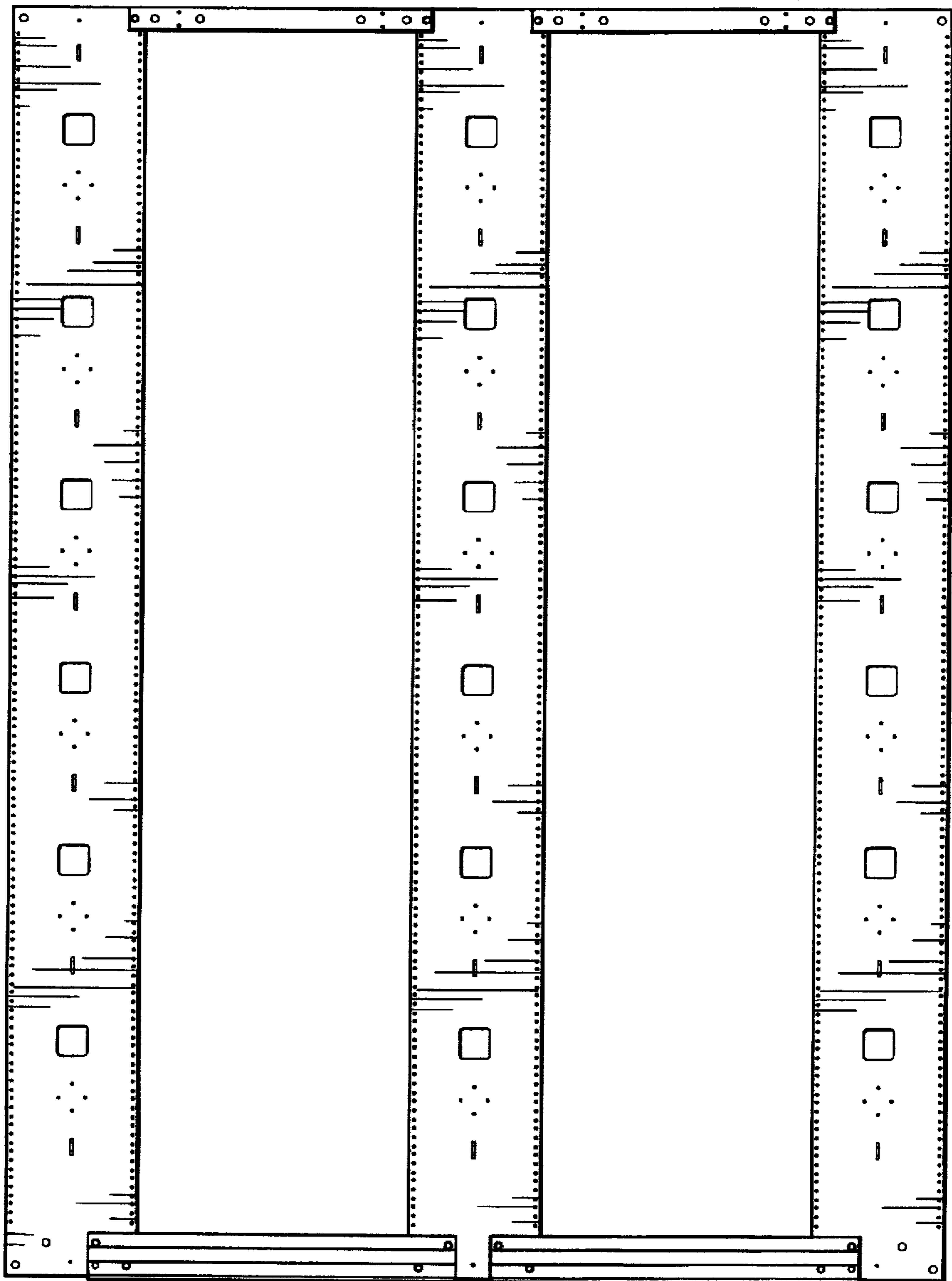

Fig. 4

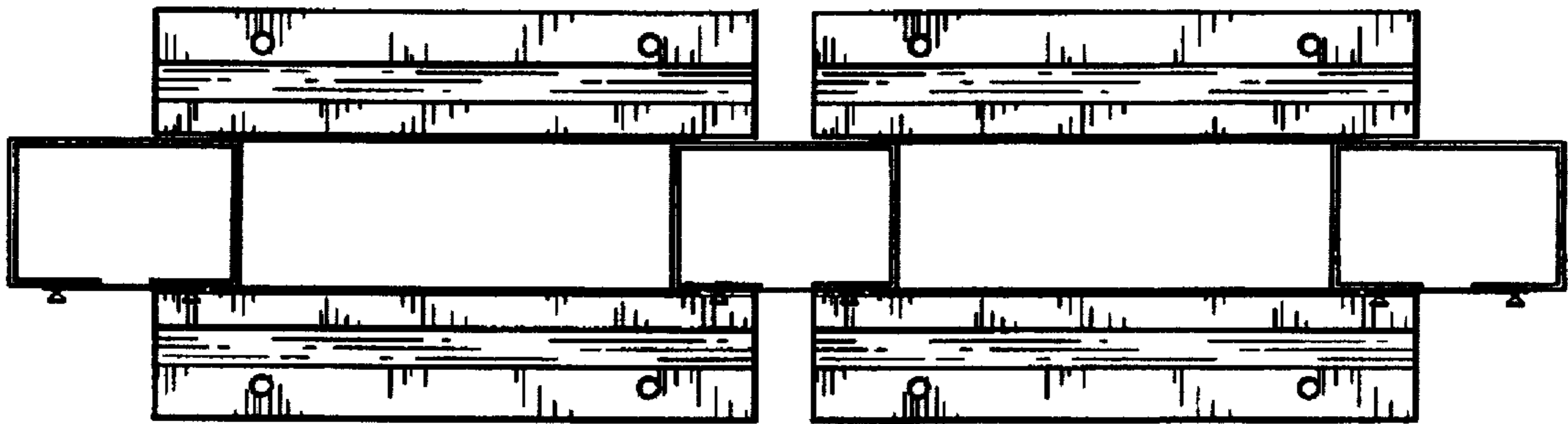

Fig. 5

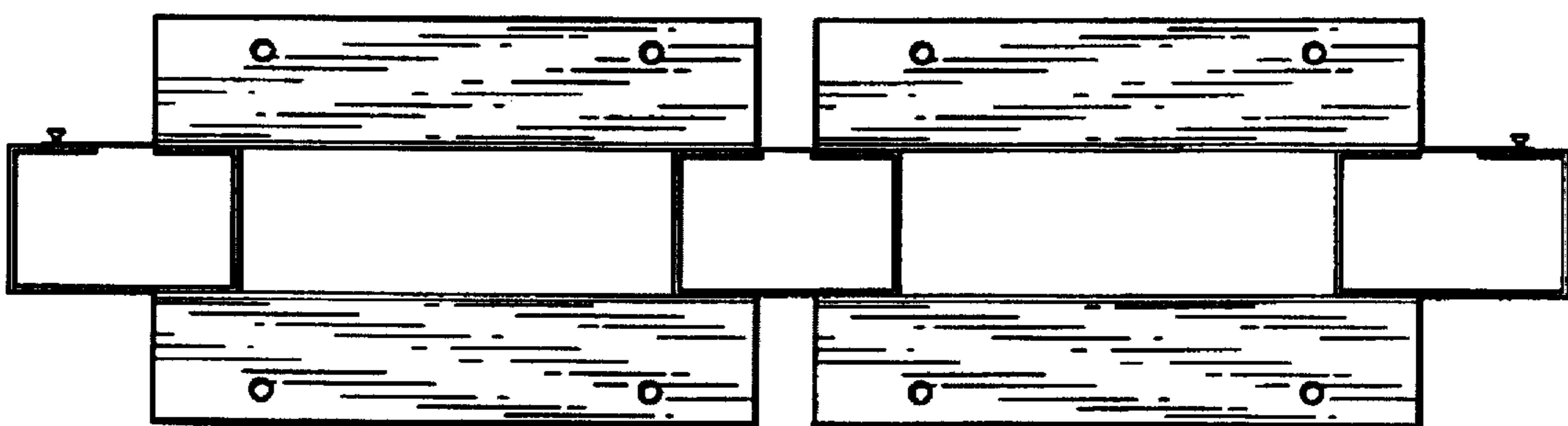

Fig. 6

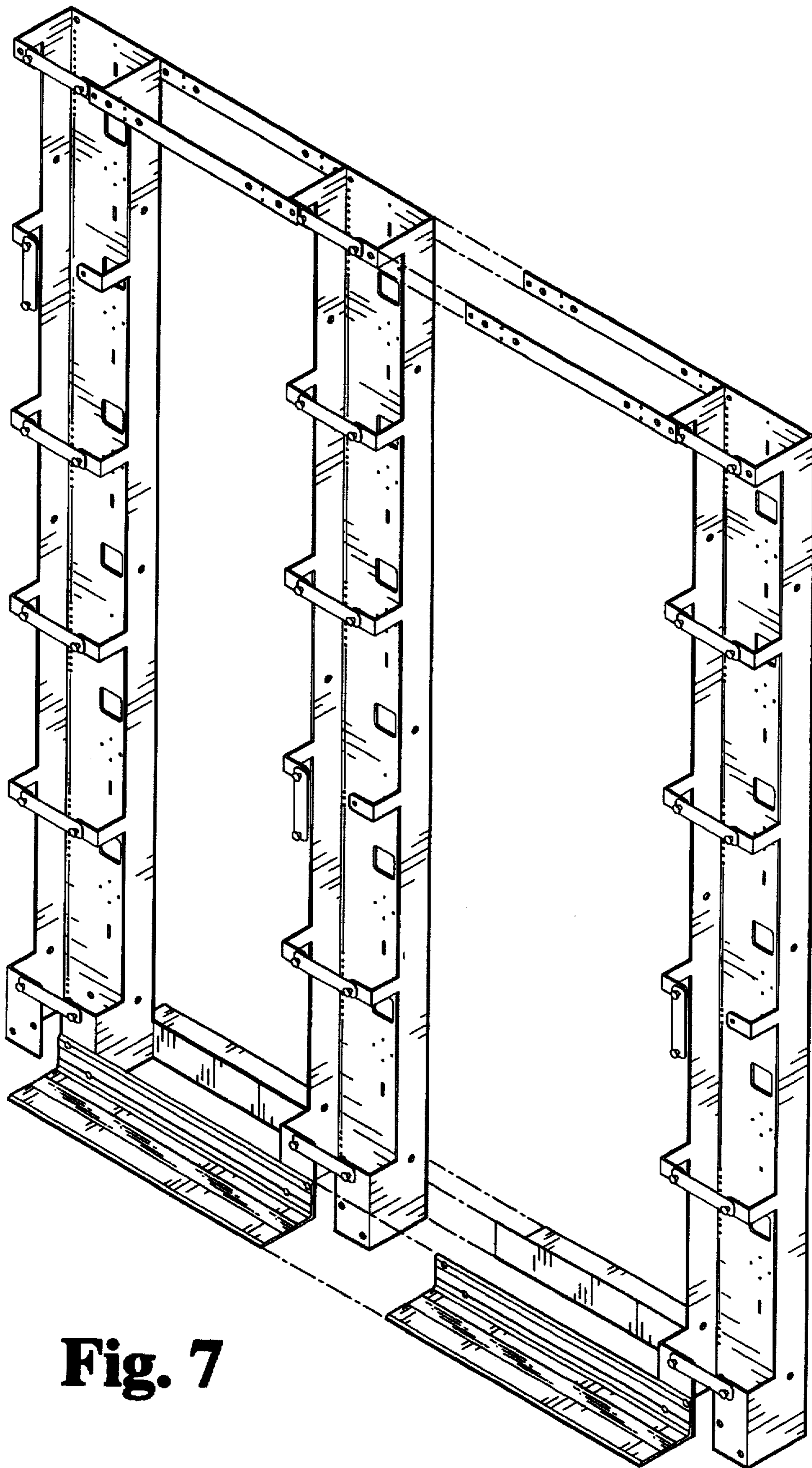

Fig. 7

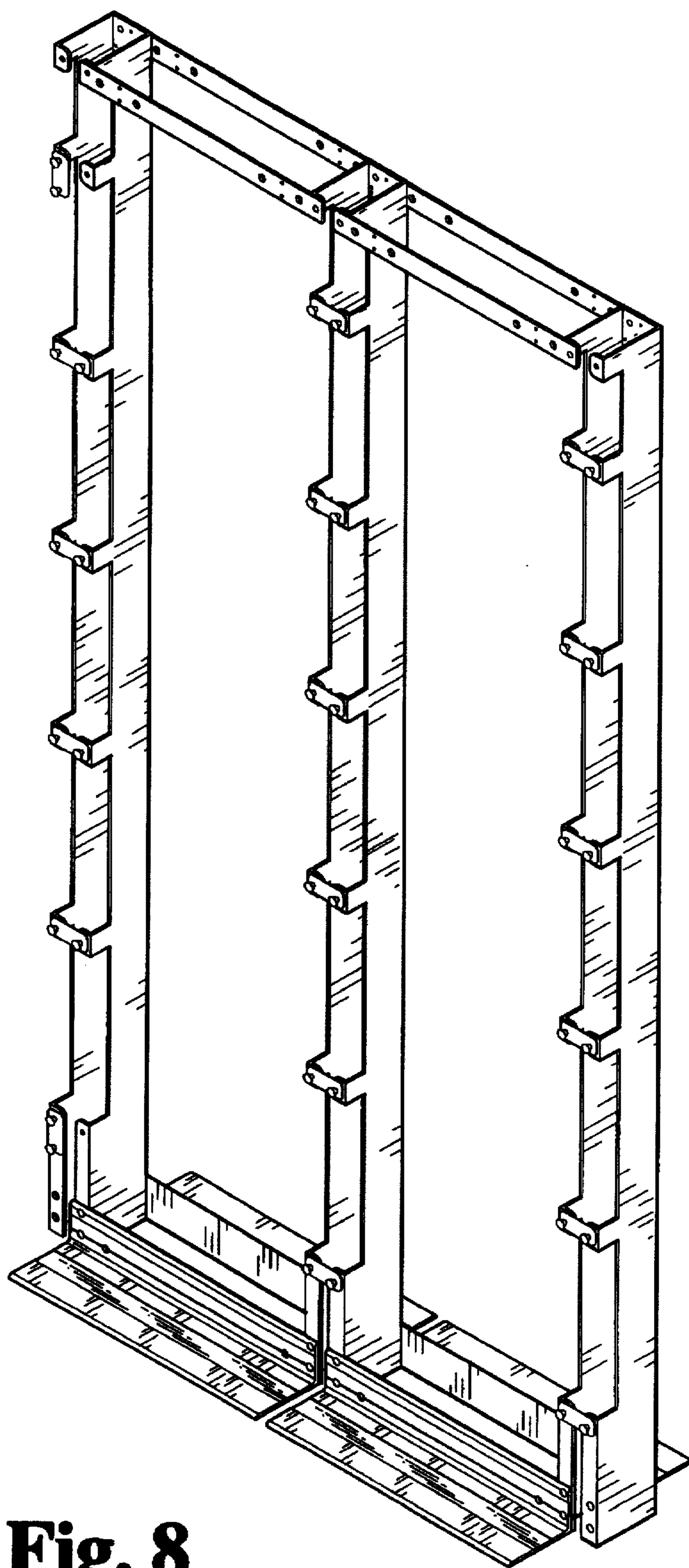

Fig. 8

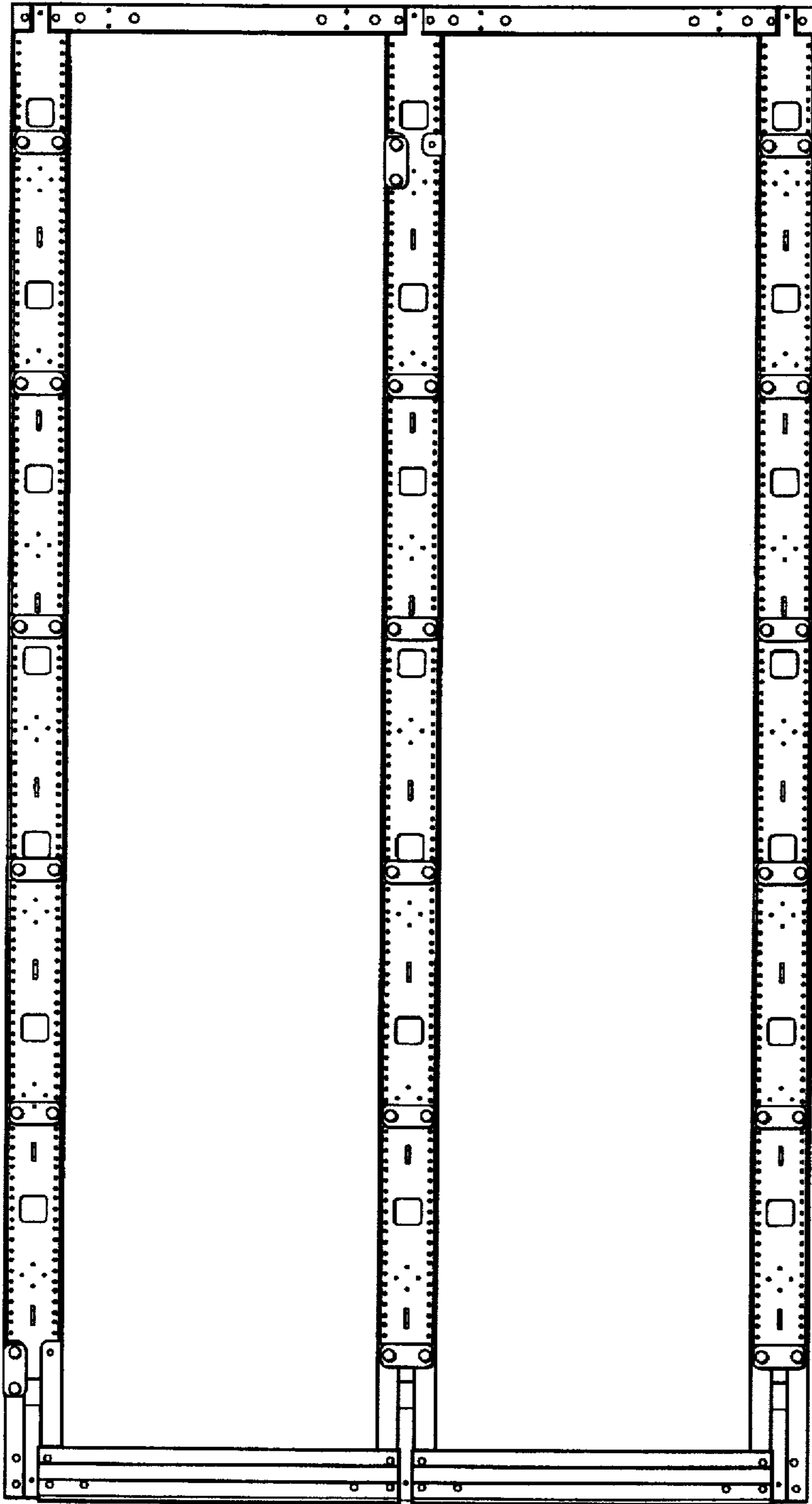

Fig. 9

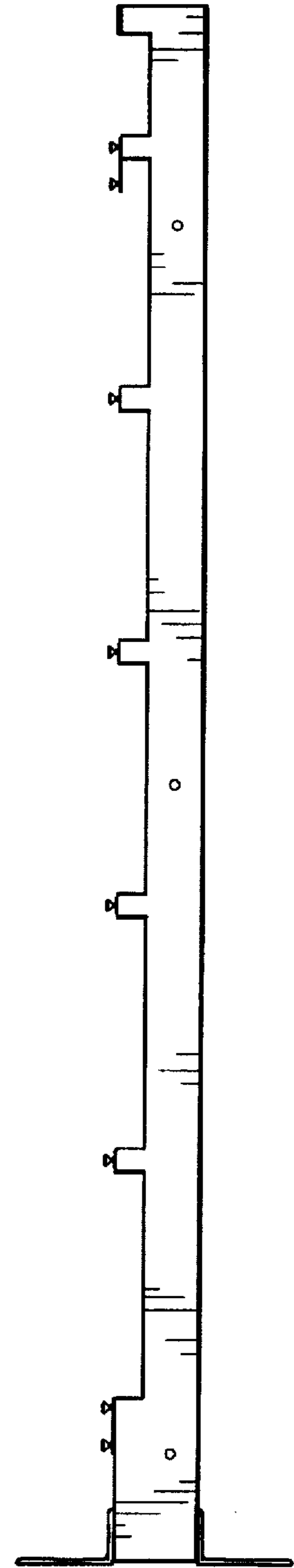

Fig. 10

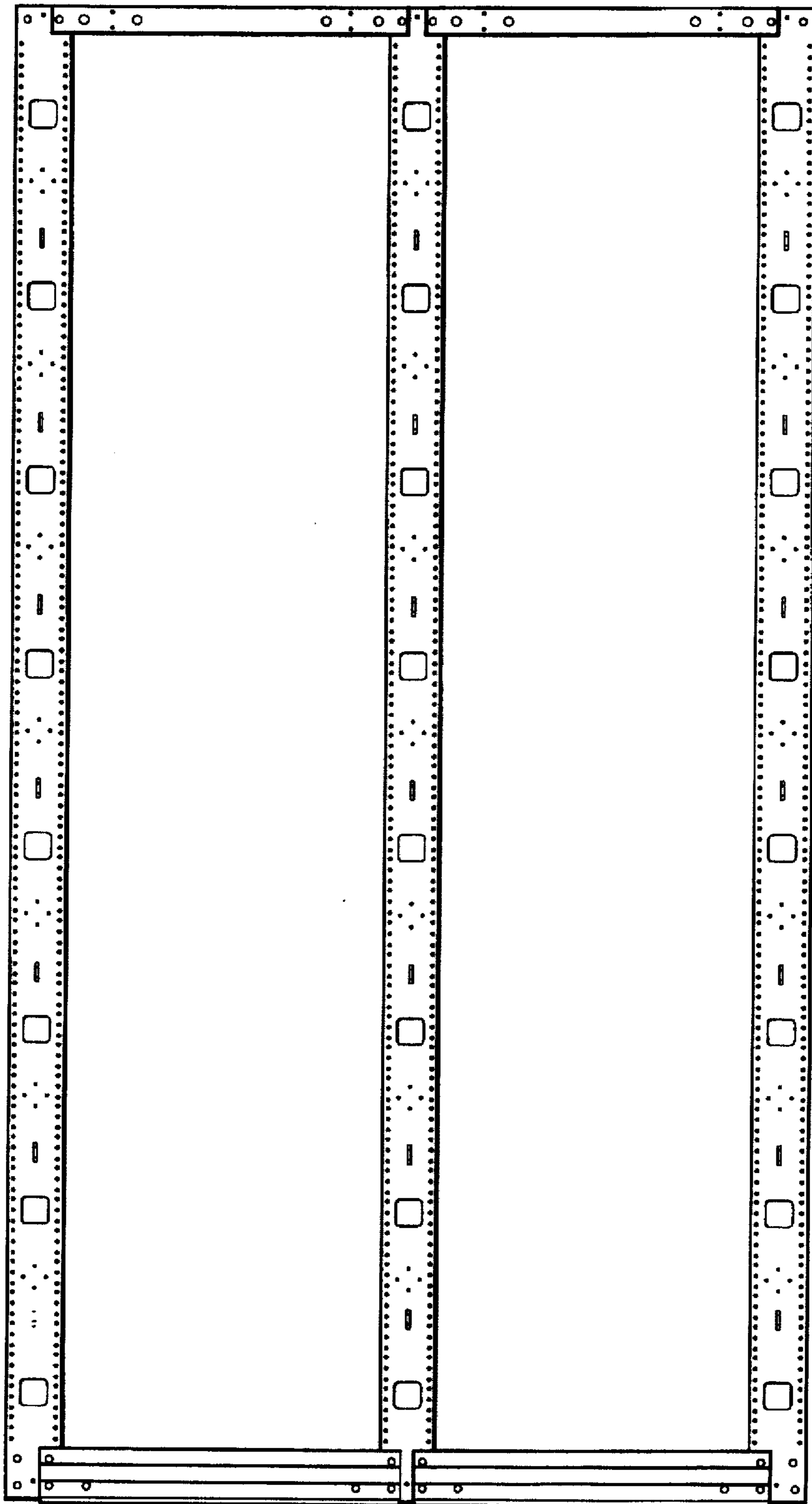

Fig. 11

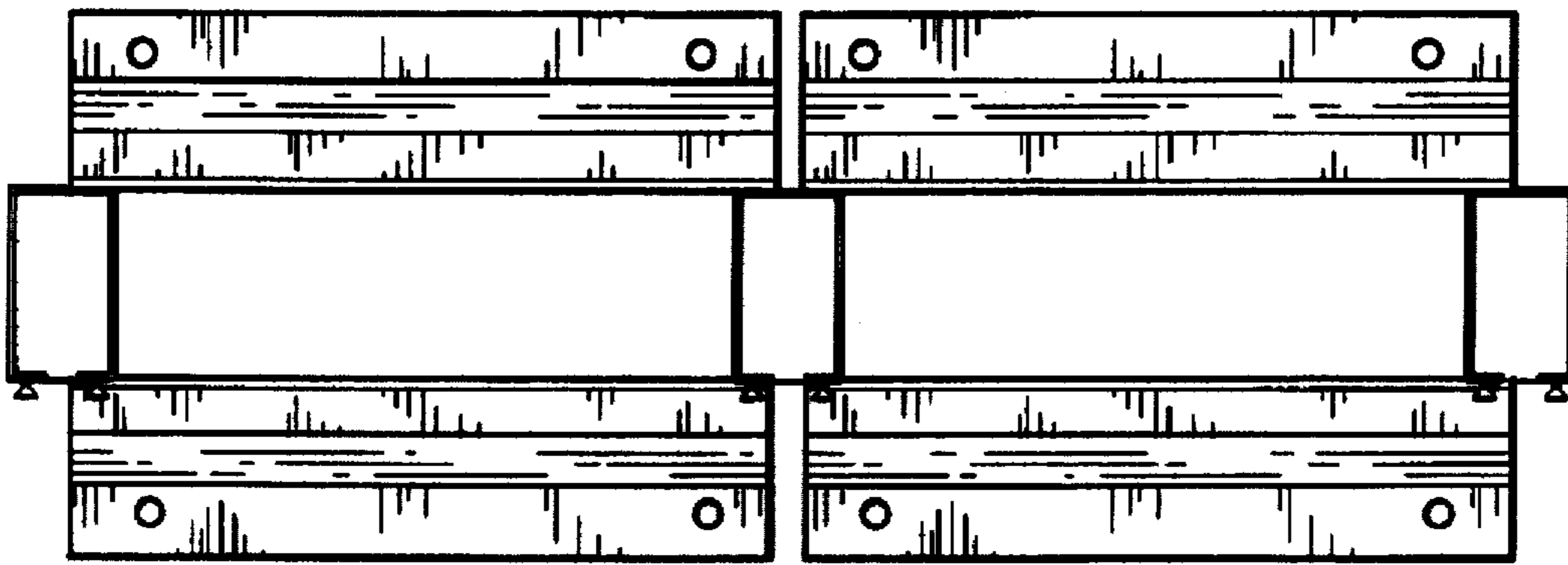

Fig. 12

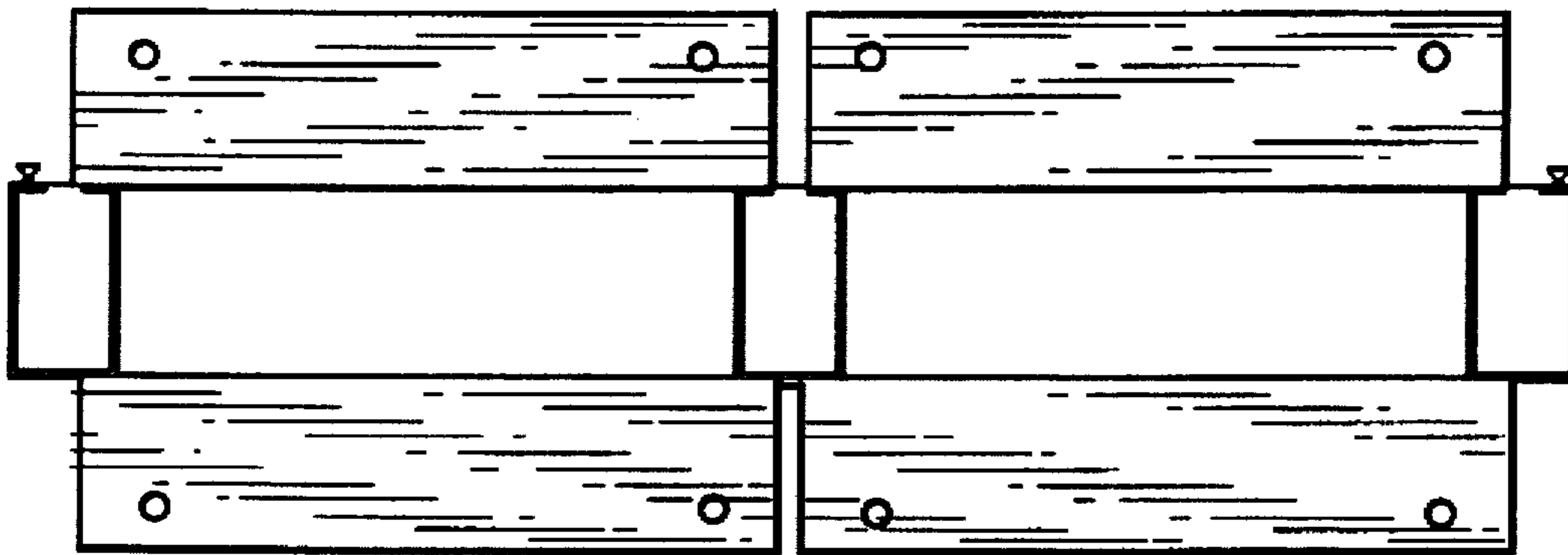

Fig. 13

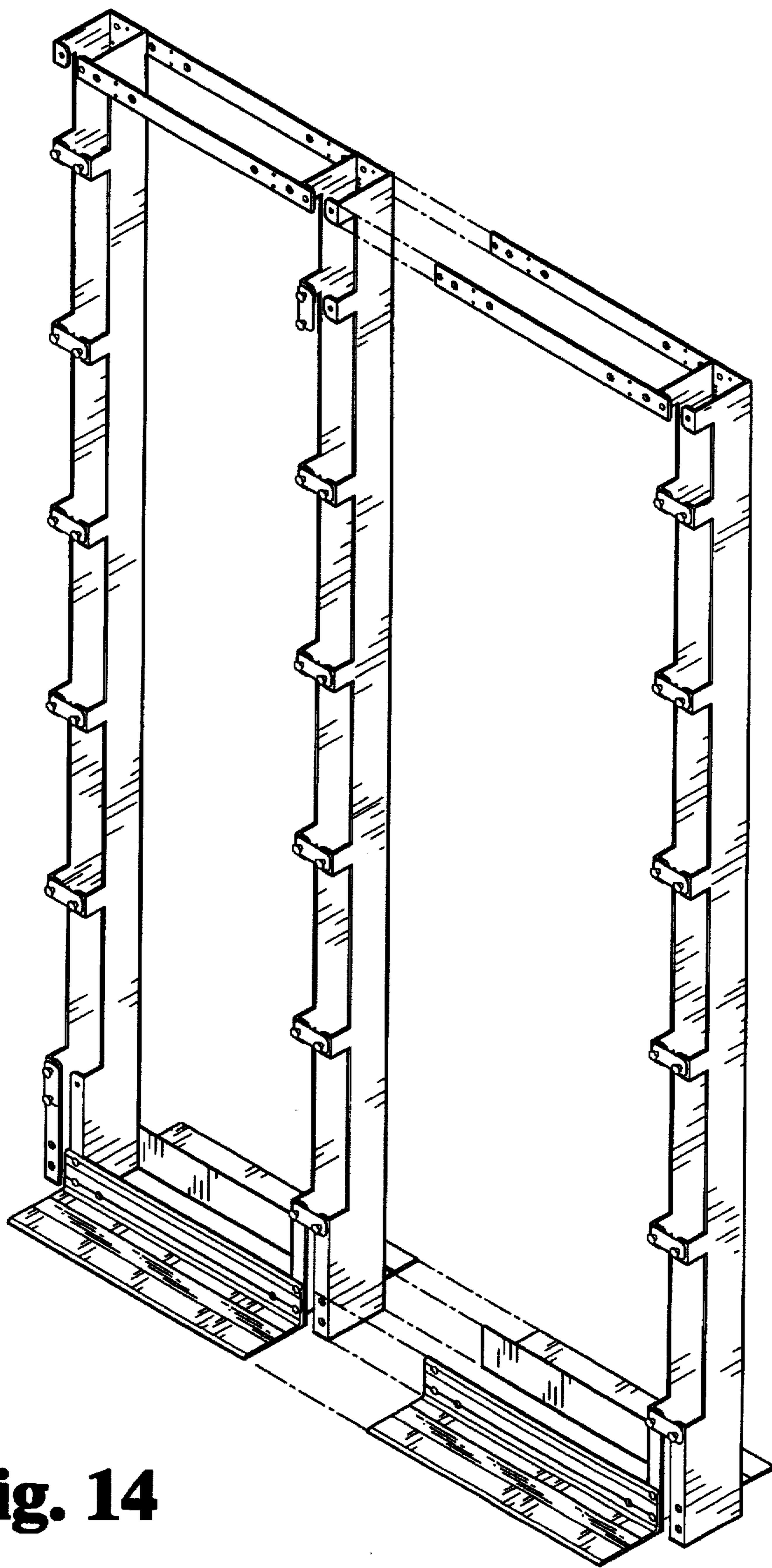

Fig. 14