



US00D388297S

United States Patent [19]

Buttenbender

[11] Patent Number: **Des. 388,297**

[45] Date of Patent: ****Dec. 30, 1997**

[54] **HEAT GUN WITH ELECTRONIC CONTROL**

[75] Inventor: **Klaus Buttenbender, Friedrichshafen, Germany**

[73] Assignee: **Wagner Spray Tech Corporation, Minneapolis, Minn.**

[**] Term: **14 Years**

[21] Appl. No.: **58,166**

[22] Filed: **Aug. 9, 1996**

[51] LOC (6) Cl. **08-05**

[52] U.S. Cl. **D8/29.1**

[58] Field of Search D8/29.1; D28/13; 34/96-101; 219/368, 369, 370, 373, 385, 482, 497, 501, 507; 392/369, 383, 384, 385; 431/158, 347, 351, 352, 353

[56] **References Cited**

U.S. PATENT DOCUMENTS

- D. 296,070 6/1988 Cunningham D8/29.1
- D. 297,397 8/1988 Pagani D8/29.1

Primary Examiner—Antoine Duval Davis
Attorney, Agent, or Firm—Faegre & Benson

[57] **CLAIM**

The ornamental design for a heat gun with electronic control, as shown.

DESCRIPTION

FIG. 1 is a perspective view of the heat gun with electronic control of the present invention;

FIG. 2 is a right hand side view thereof;

FIG. 3 is a front view thereof;

FIG. 4 is a left hand side view thereof;

FIG. 5 is a top view thereof;

FIG. 6 is a bottom view thereof; and,

FIG. 7 is a rear view thereof.

1 Claim, 7 Drawing Sheets

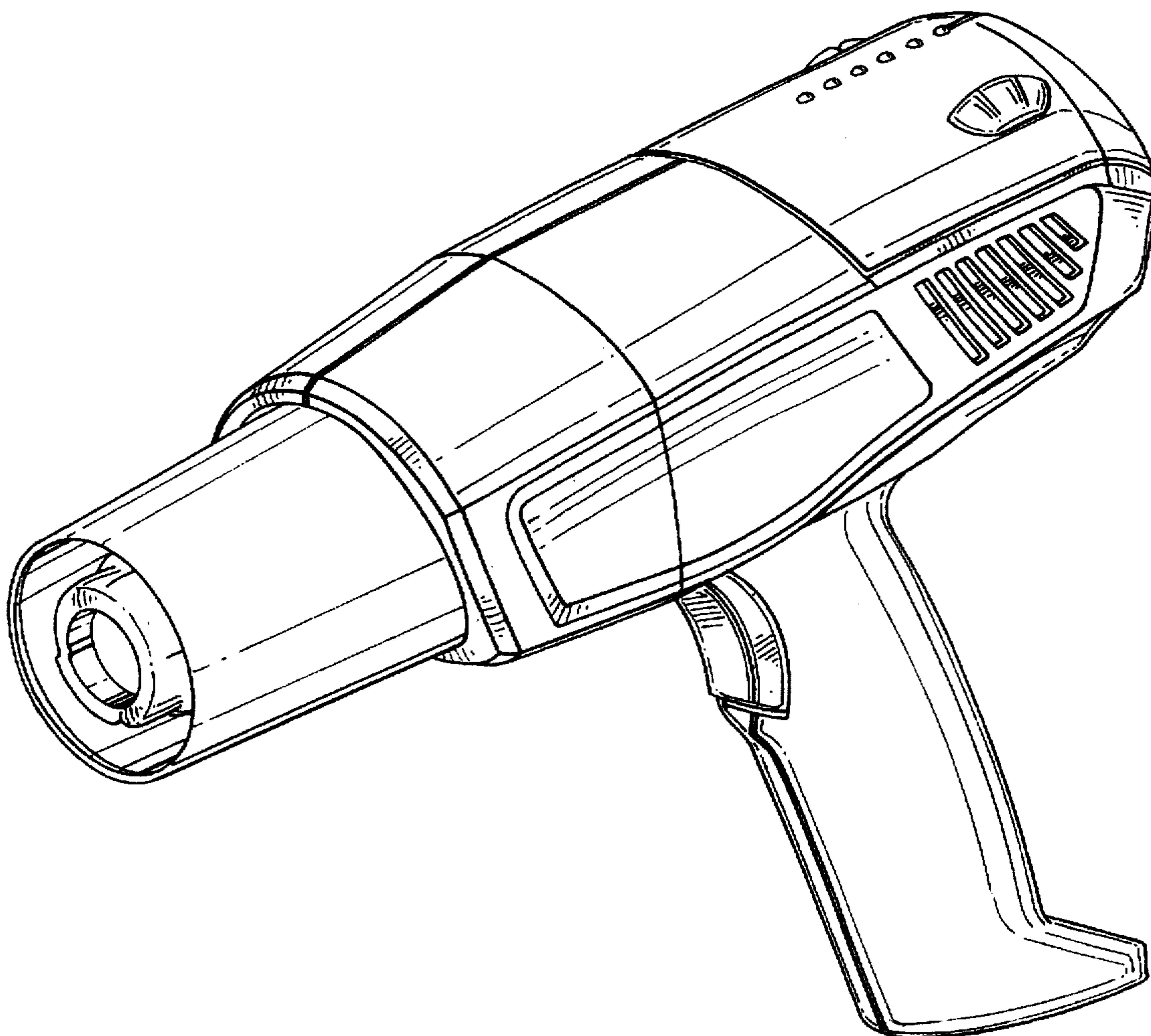

Fig. 1

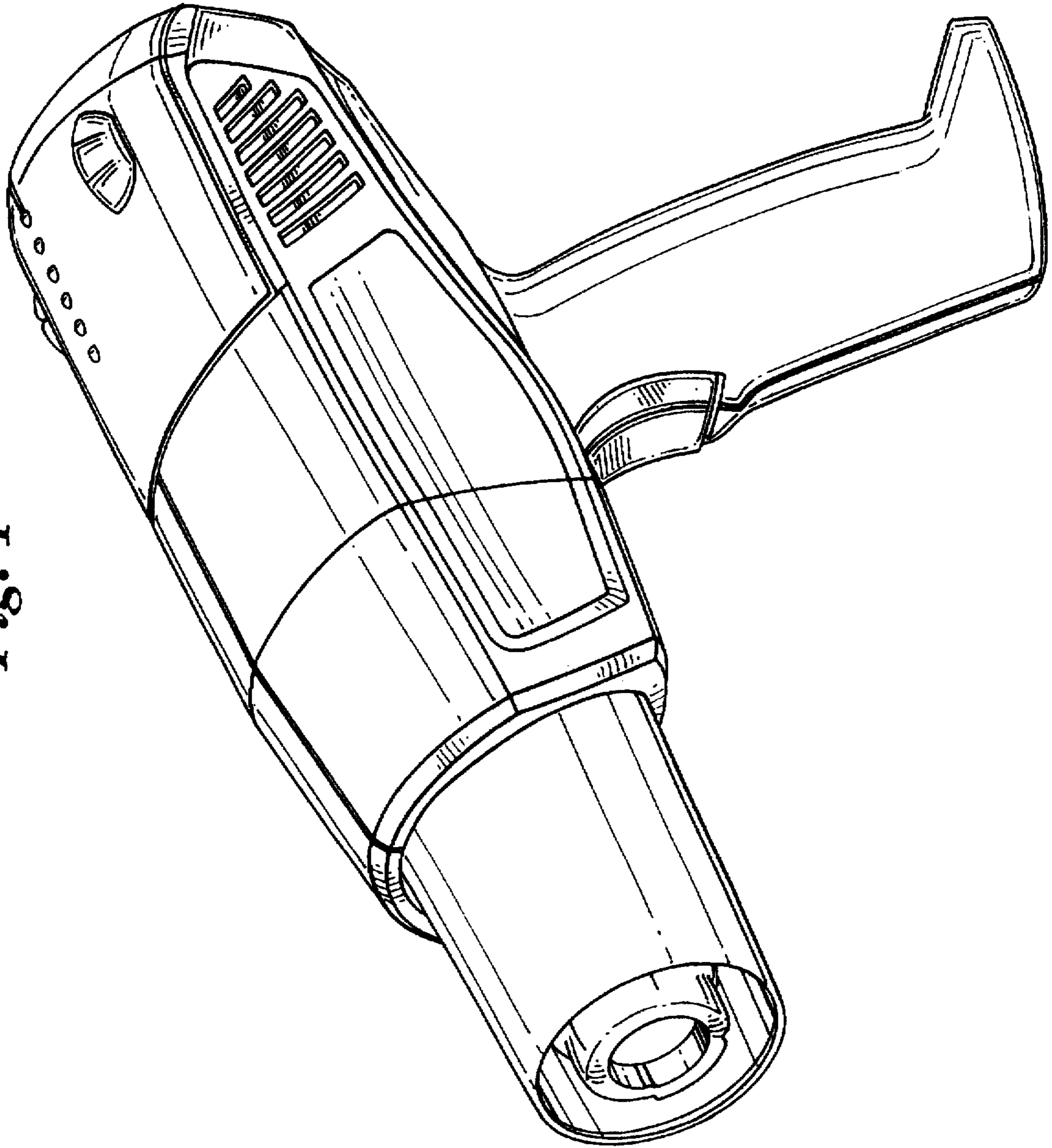

Fig. 2

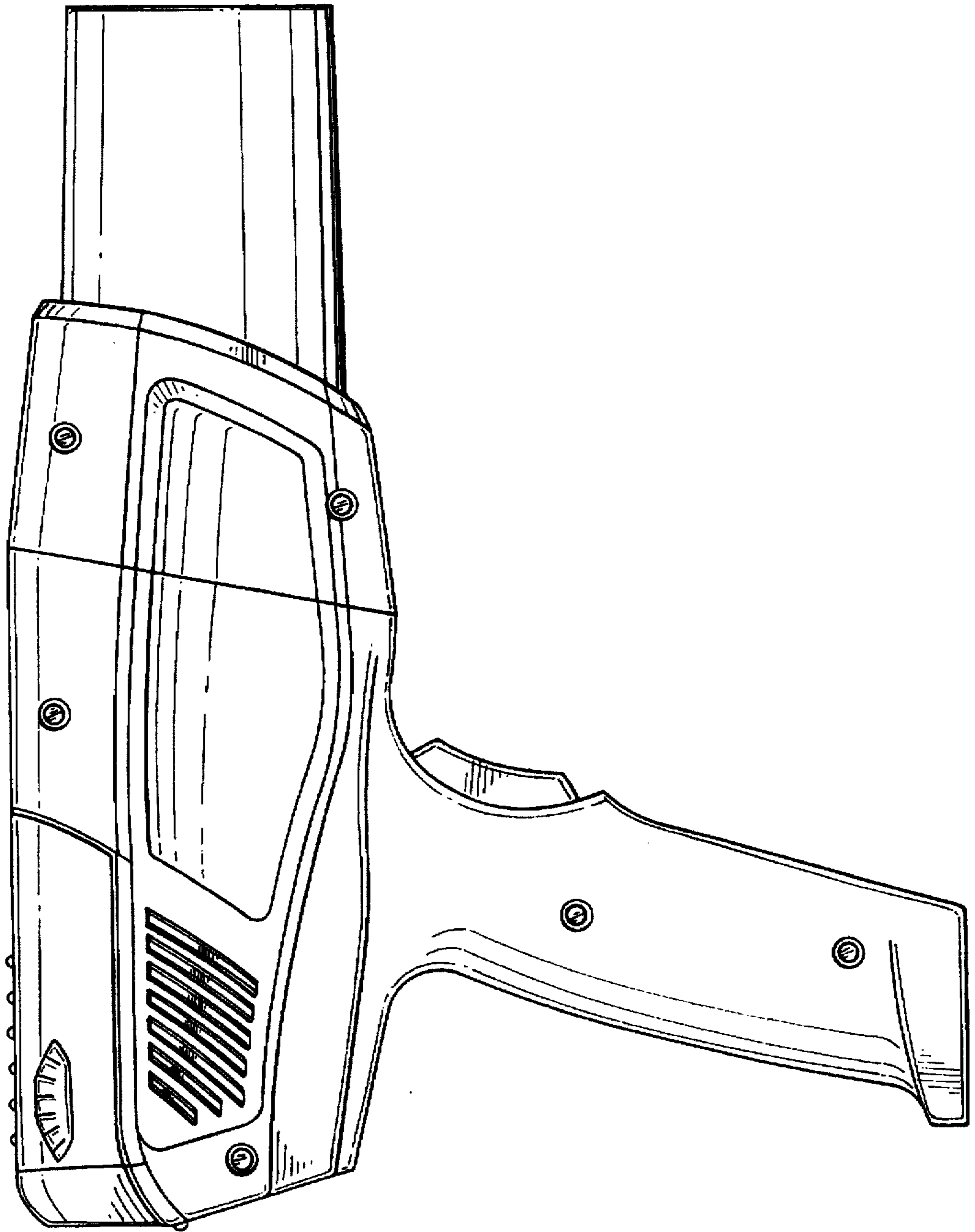

Fig. 3

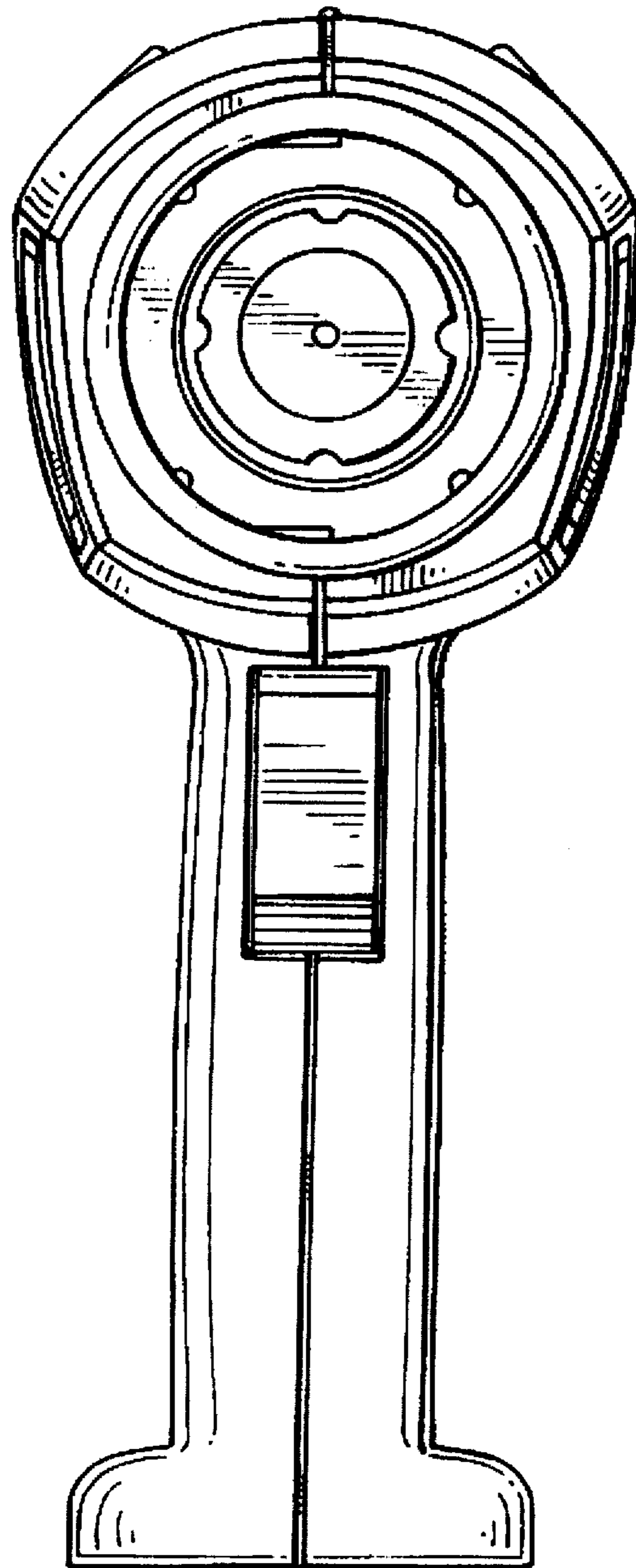

Fig. 4

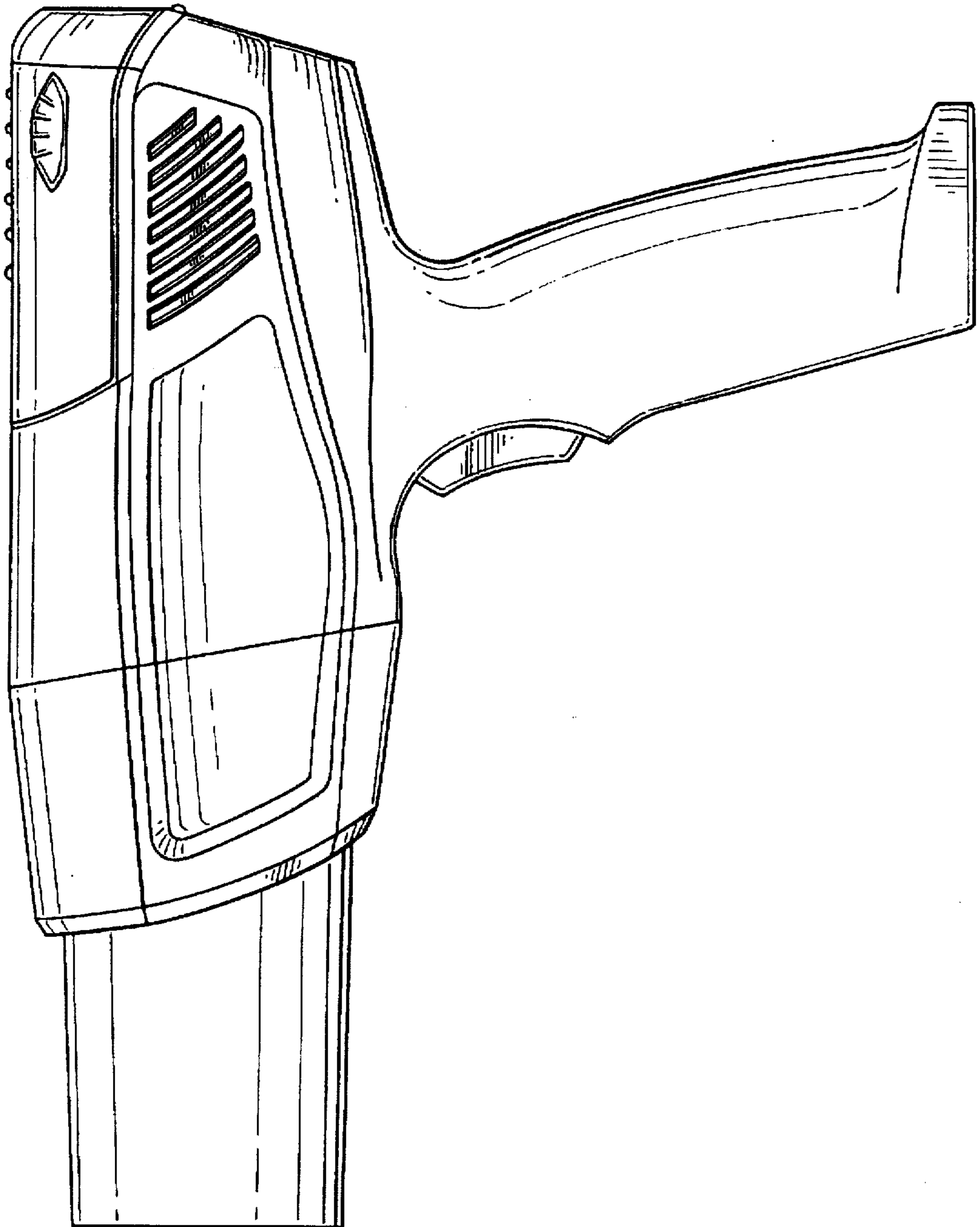

Fig. 5

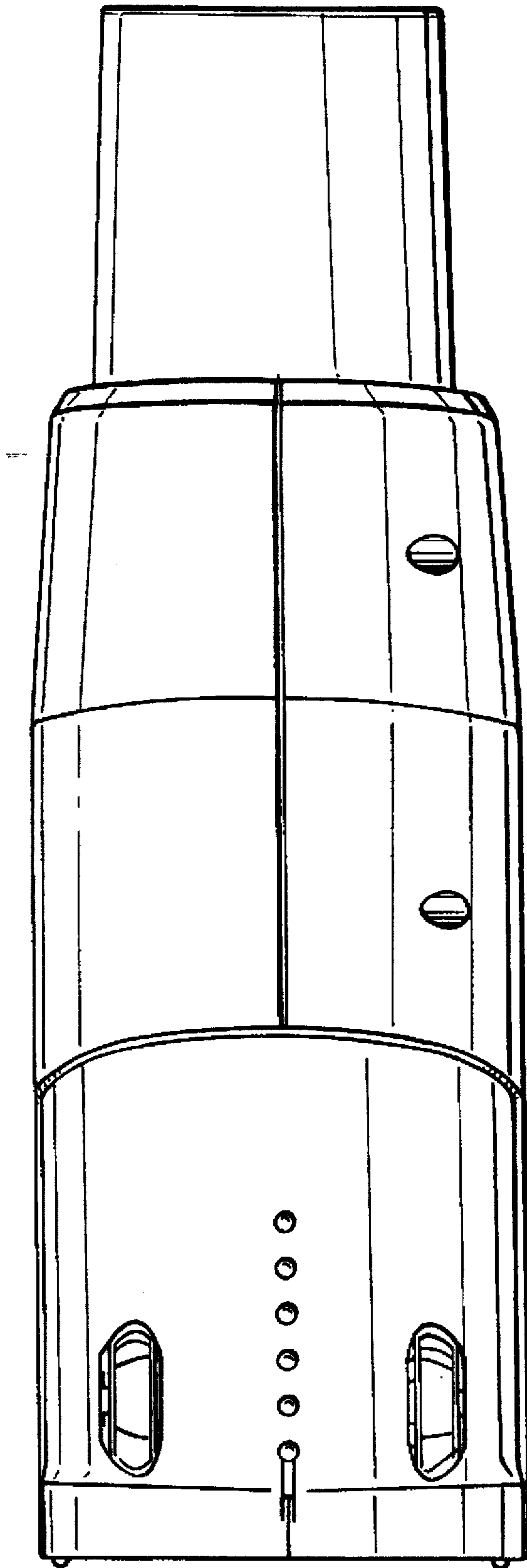

Fig. 6

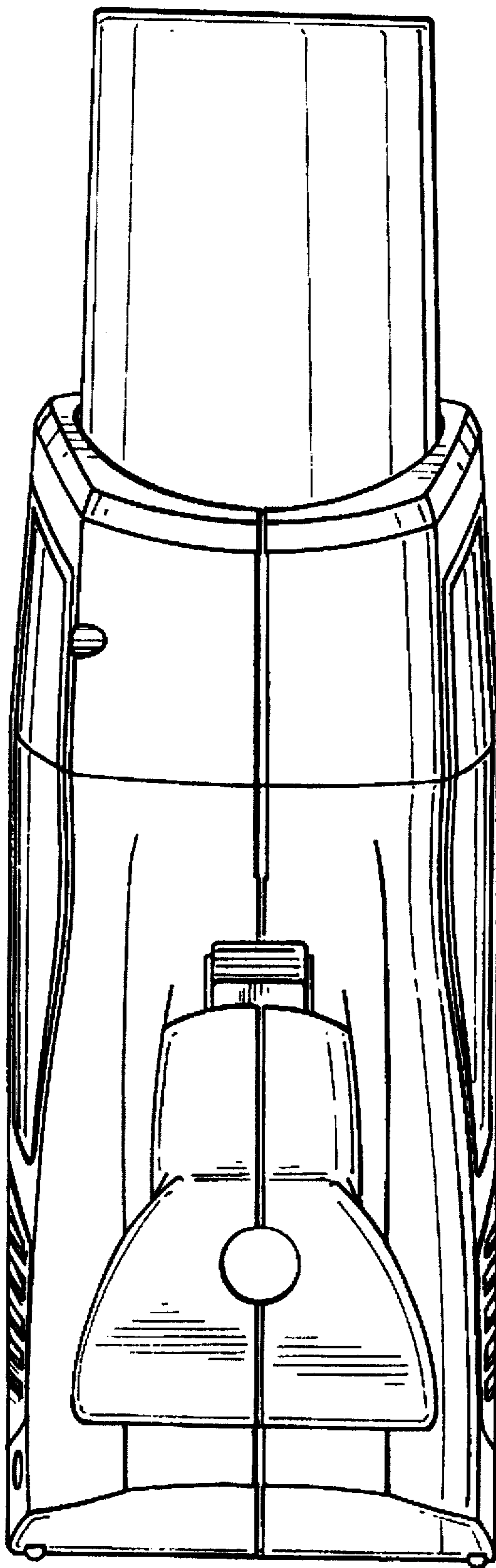

Fig. 7

