



US00D388261S

United States Patent [19]

[11] Patent Number: Des. 388,261

Natuzzi et al.

[45] Date of Patent: **Dec. 30, 1997

[54] SEAT

[75] Inventors: **Pasquale Natuzzi; Raffaella Lucarelli**, both of Santeramo In Colle, Italy

[73] Assignee: **Industrie Natuzzi, Spa**, Bari, Italy

[**] Term: **14 Years**

[21] Appl. No.: **64,393**

[22] Filed: **Dec. 30, 1996**

[51] LOC (6) Cl. **06-01**

[52] U.S. Cl. **D6/381; D6/334**

[58] Field of Search **D6/334, 335, 364, D6/371, 373, 381, 500, 501, 502; 297/232, 445.1**

[56] References Cited

U.S. PATENT DOCUMENTS

D. 290,195 6/1987 Kanowsky D6/381

OTHER PUBLICATIONS

Drexel Traditional Classics, Sofa #777-867 at top, p. 25, May 8, 1979.

Ethan Allen, p. 91, Sofa #20-7235-5 at top right, Dec. 1988. Natuzzi Model 866 line drawings, International Home Furnishings Market, High Point, NC, Oct. 1991.

Natuzzi Model 836, Apr., 1991, at International Home Furnishings Market in High Point, North Carolina.

Natuzzi Model 866, Oct., 1991, at International Home Furnishings Market in High Point, North Carolina.

Natuzzi Model 1046, Apr., 1993, at International Home Furnishings Market in High Point, North Carolina.

Natuzzi Model 1059, Apr., 1993, at International Home Furnishings Market in High Point, North Carolina.

Natuzzi Model 1068, Oct., 1993, at International Home Furnishings Market in High Point, North Carolina.

Natuzzi Model 1105, Oct., 1993, at International Home Furnishings Market in High Point, North Carolina.

Natuzzi Model 1141, Apr., 1994, at International Home Furnishings Market in High Point, North Carolina.

Natuzzi Model 1201, Oct., 1994, at International Home Furnishings Market in High Point, North Carolina.

Natuzzi Model 1293, Mar., 1995, at International Home Furnishings Market in High Point, North Carolina.

Natuzzi Model 1299, Apr., 1995, at International Home Furnishings Market in High Point, North Carolina.

Natuzzi Model 1349, Sep., 1995, at International Home Furnishings Market in High Point, North Carolina.

Primary Examiner—Gary D. Watson

Attorney, Agent, or Firm—Bell, Seltzer, Park & Gibson, P.A.

[57] CLAIM

The ornamental design for a seat, as shown and described.

DESCRIPTION

FIG. 1 is a front perspective view of a seat showing our new design in the form of a sofa;

FIG. 2 is a front elevational view thereof;

FIG. 3 is a top plan view thereof;

FIG. 4 is a right side elevational view, the left side being a mirror image thereof;

FIG. 5 is a rear perspective view thereof;

FIG. 6 is a front elevational view of a seat showing our new design in the form of a loveseat; and,

FIG. 7 is a front elevational view of a seat showing our new design in the form of a chair.

The broken lines shown herein are for illustrative purposes only and form no part of the claimed design.

The rear views of FIGS. 6 and 7 are like FIG. 5, the difference being a matter of length.

The end views of FIGS. 6 and 7 are like that shown in FIG. 4.

FIGS. 1 and 5 have been shown on an enlarged scale with respect to the other views.

1 Claim, 3 Drawing Sheets

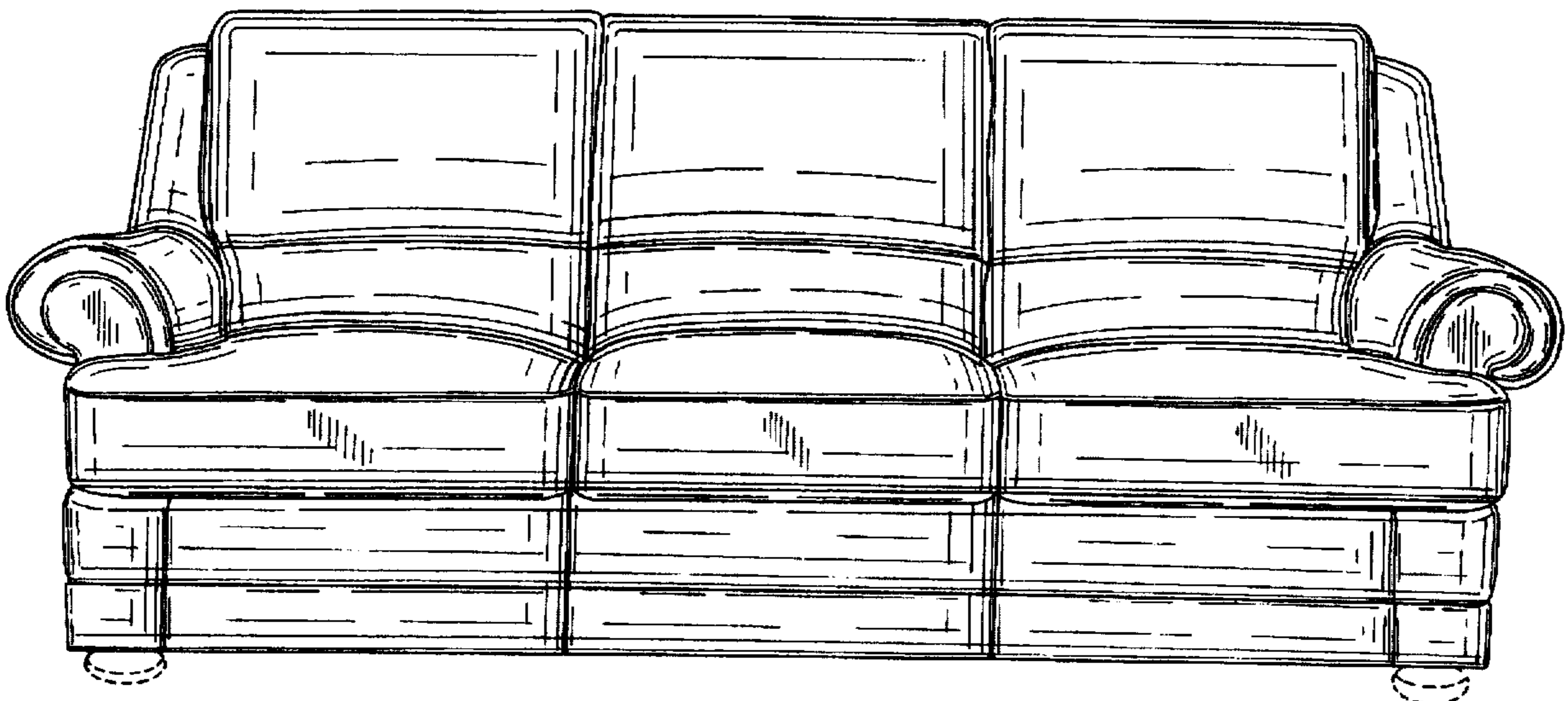

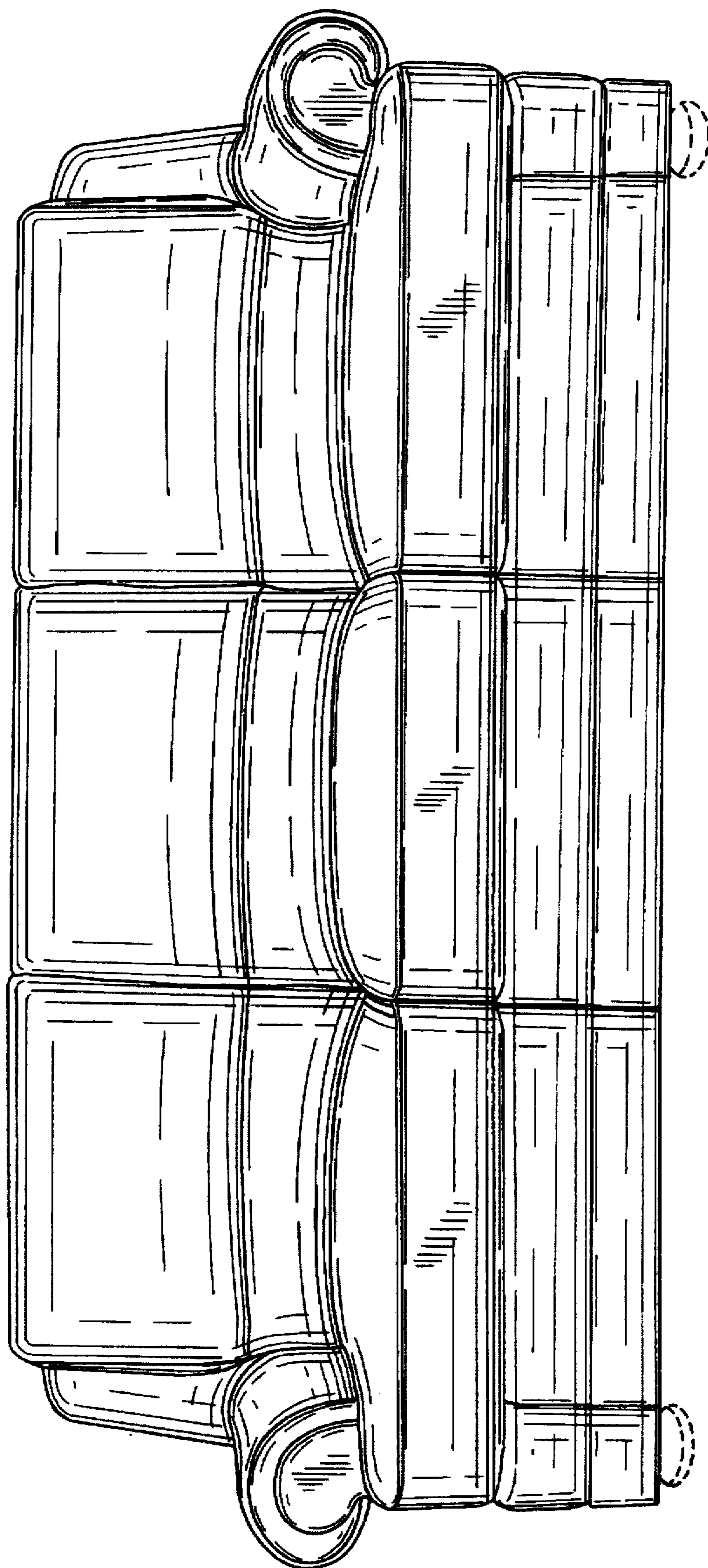

FIG. 1.

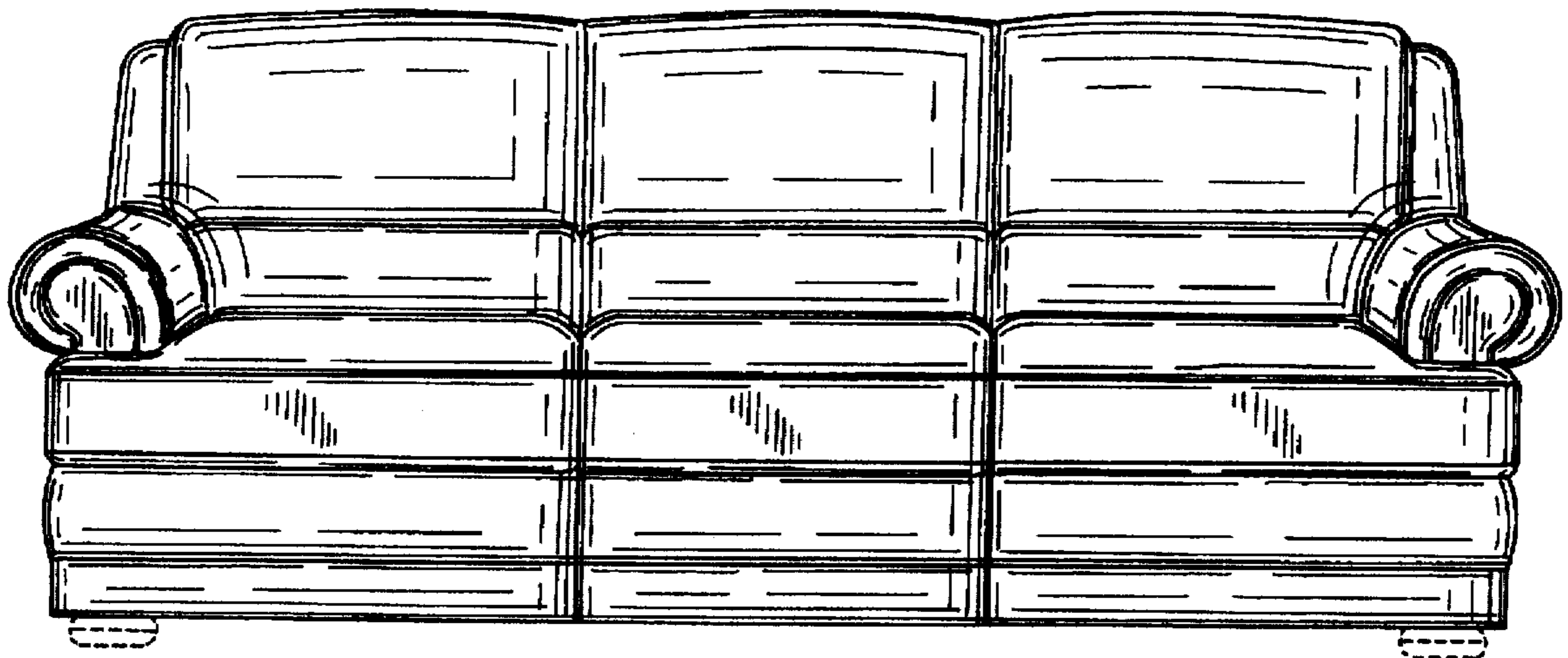

FIG. 2.



FIG. 3.

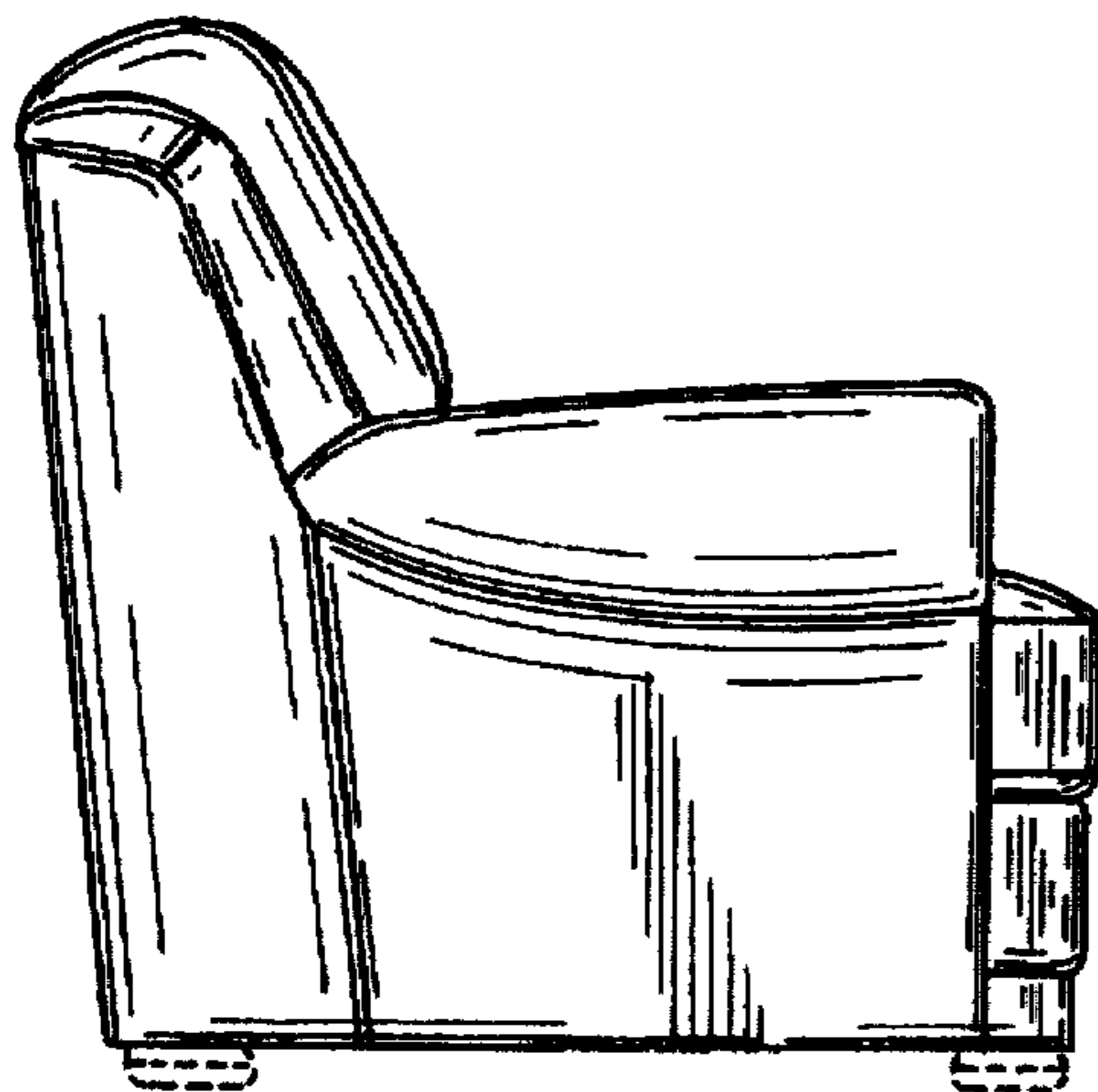

FIG. 4.

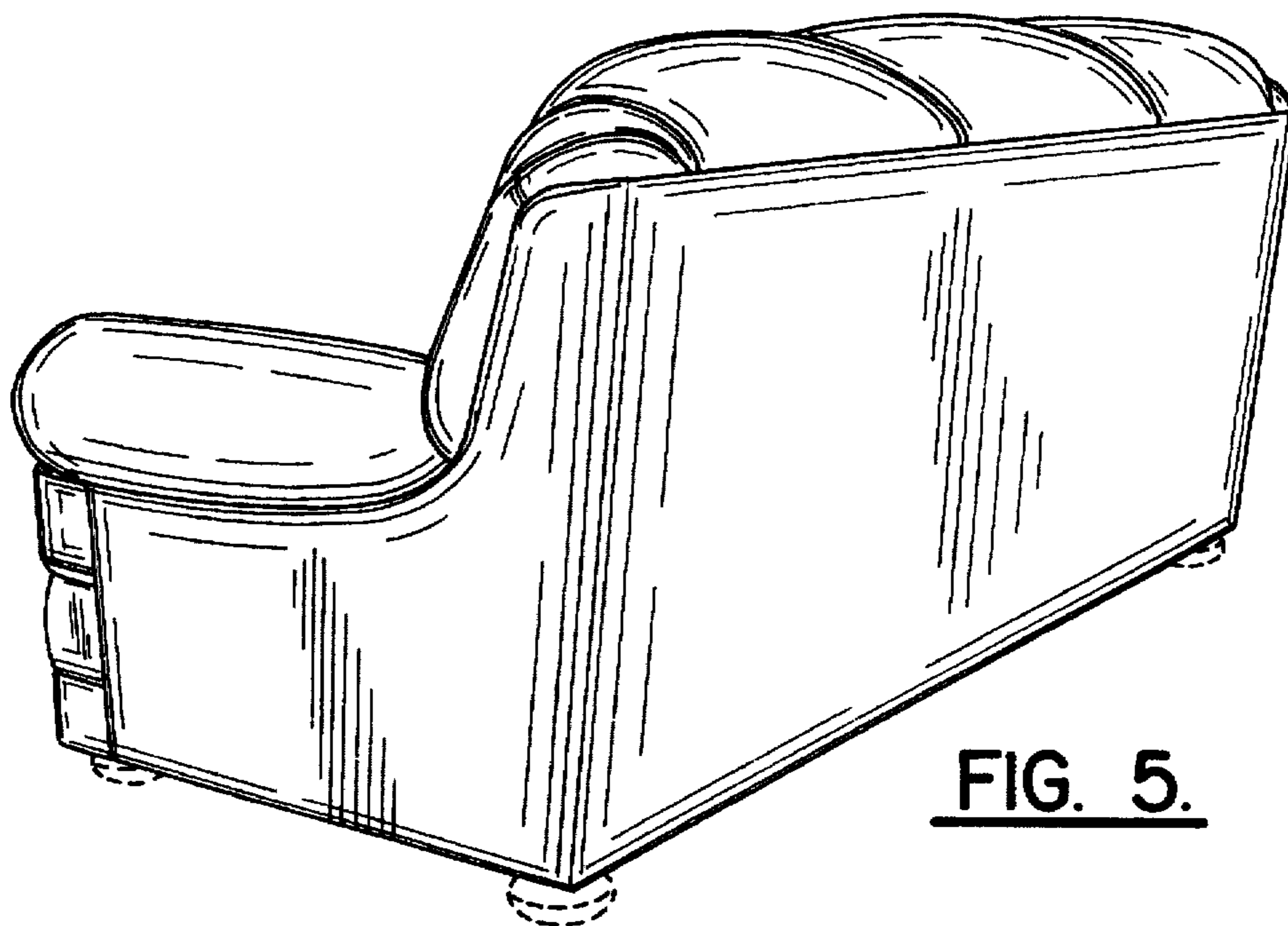

FIG. 5.

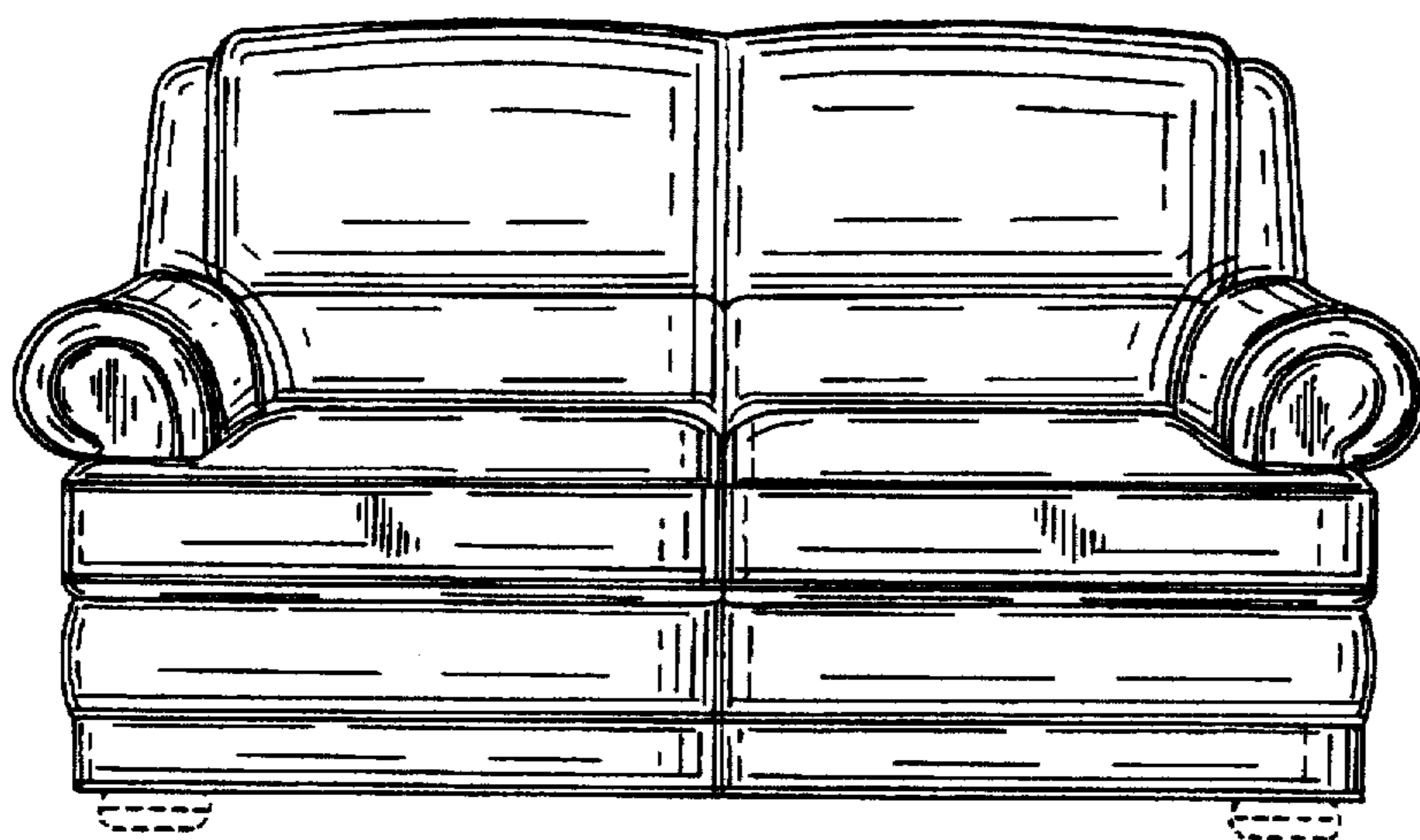

FIG. 6.

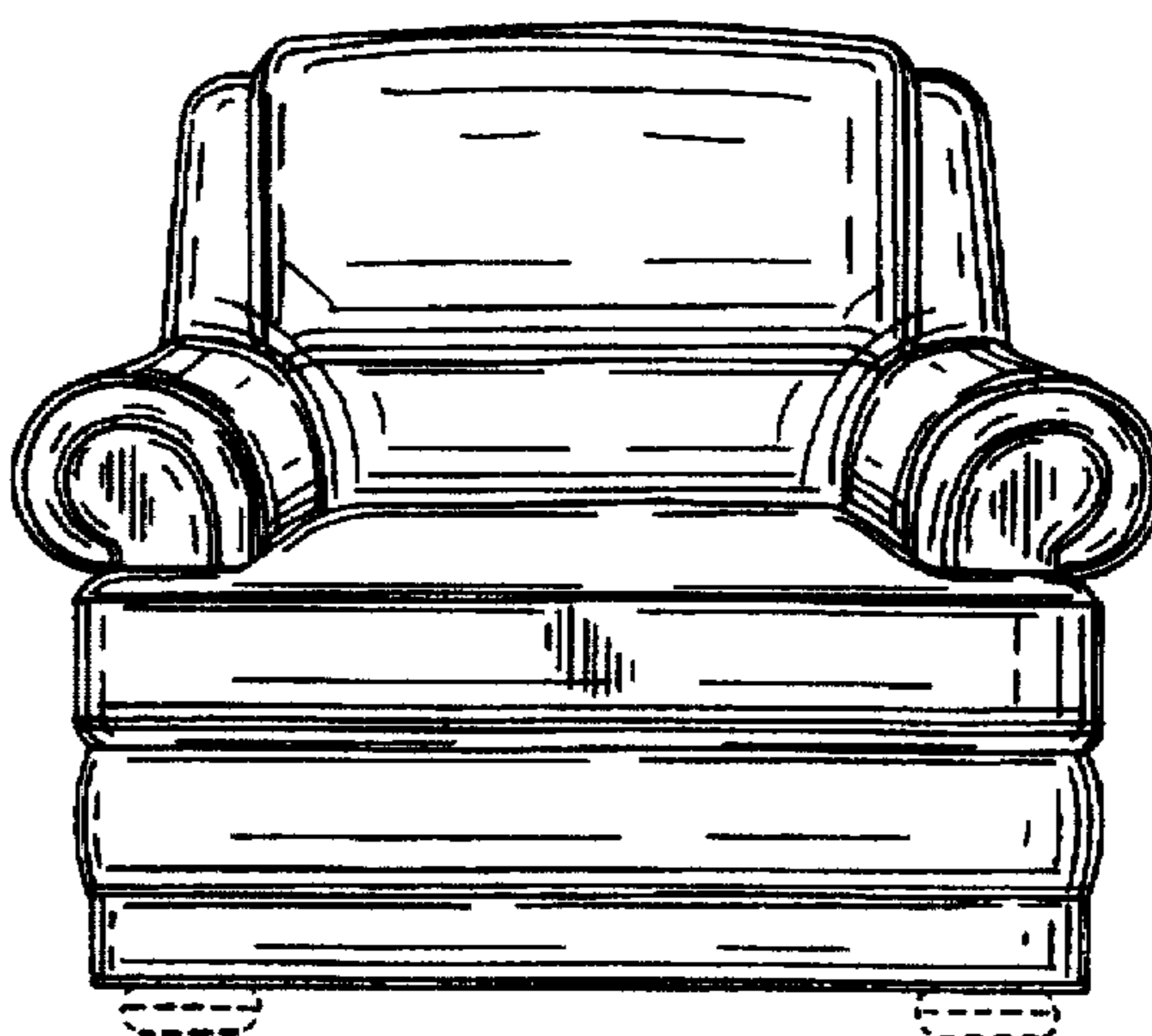

FIG. 7.