



US00D388258S

# United States Patent [19]

Ambasz

[11] Patent Number: Des. 388,258

[45] Date of Patent: \*\*Dec. 30, 1997

[54] CHAIR

[75] Inventor: Emilio Ambasz, Buenos Aires, Argentina

[73] Assignee: Center for Design Research & Development N.V., Curacao, Netherlands Antilles

[\*\*] Term: 14 Years

[21] Appl. No.: 59,991

[22] Filed: Sep. 19, 1996

[51] LOC (6) CL ..... 06-01

[52] U.S. Cl. .... D6/366

[58] Field of Search ..... D6/334, 364, 365, D6/366, 367, 379, 500, 501, 502; 297/411.2

[56] **References Cited**

**U.S. PATENT DOCUMENTS**

|            |         |                      |        |
|------------|---------|----------------------|--------|
| D. 184,187 | 12/1958 | McCarthy et al. .... | D6/366 |
| D. 184,188 | 12/1958 | McCarthy et al. .... | D6/366 |
| D. 248,068 | 6/1978  | Roericht .....       | D6/366 |
| D. 282,510 | 2/1986  | Diffrient .....      | D6/366 |
| D. 296,624 | 7/1988  | Bellini .....        | D6/366 |
| D. 296,735 | 7/1988  | Hollington .....     | D6/366 |
| D. 305,183 | 12/1989 | Carter et al. ....   | D6/366 |
| D. 308,605 | 6/1990  | Decker et al. ....   | D6/366 |
| D. 320,507 | 10/1991 | Shields .....        | D6/366 |

Primary Examiner—Gary D. Watson  
Attorney, Agent, or Firm—Brumbaugh, Graves, Donohue & Raymond

[57] **CLAIM**

The ornamental design for a chair, as shown and described.

**DESCRIPTION**

FIG. 1 is a front pictorial view of a first embodiment of a chair according to my new design;  
 FIG. 2 is a rear pictorial view of the first embodiment;  
 FIG. 3 is a left side pictorial view of the first embodiment;  
 FIG. 4 is a right side pictorial view of the first embodiment;  
 FIG. 5 is a top pictorial view of the first embodiment;  
 FIG. 6 is a bottom pictorial view of the first embodiment;  
 FIG. 7 is a front pictorial view of a second embodiment of a chair according to my new design;  
 FIG. 8 is a rear pictorial view of the second embodiment;  
 FIG. 9 is a left side pictorial view of the second embodiment;  
 FIG. 10 is a right side pictorial view of the second embodiment;  
 FIG. 11 is a top pictorial view of the second embodiment and,  
 FIG. 12 is a bottom pictorial view of the second embodiment.

The fragmented cross-hatching representing fabric, is understood to be continuous throughout the implied areas.

**1 Claim, 6 Drawing Sheets**

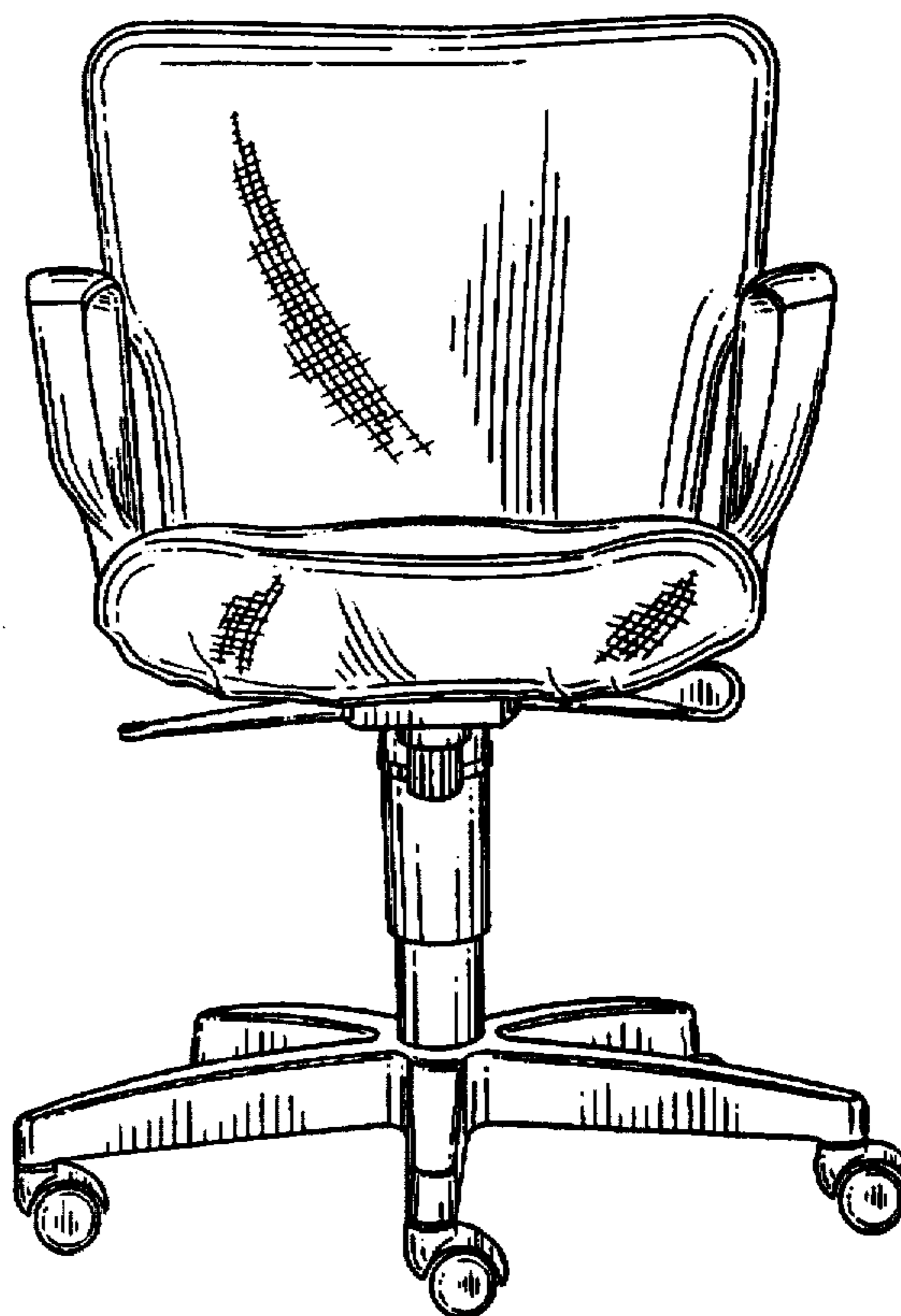
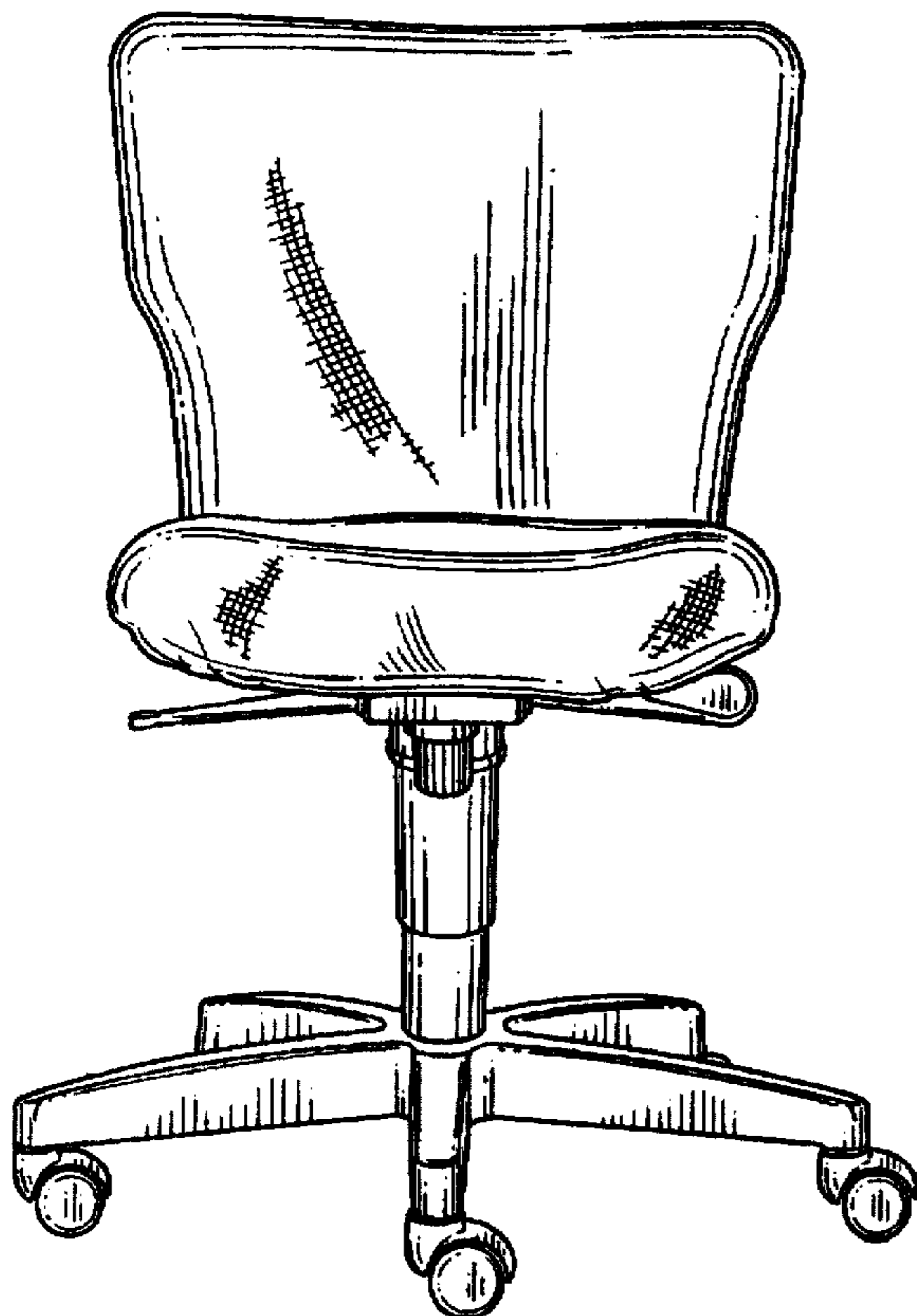

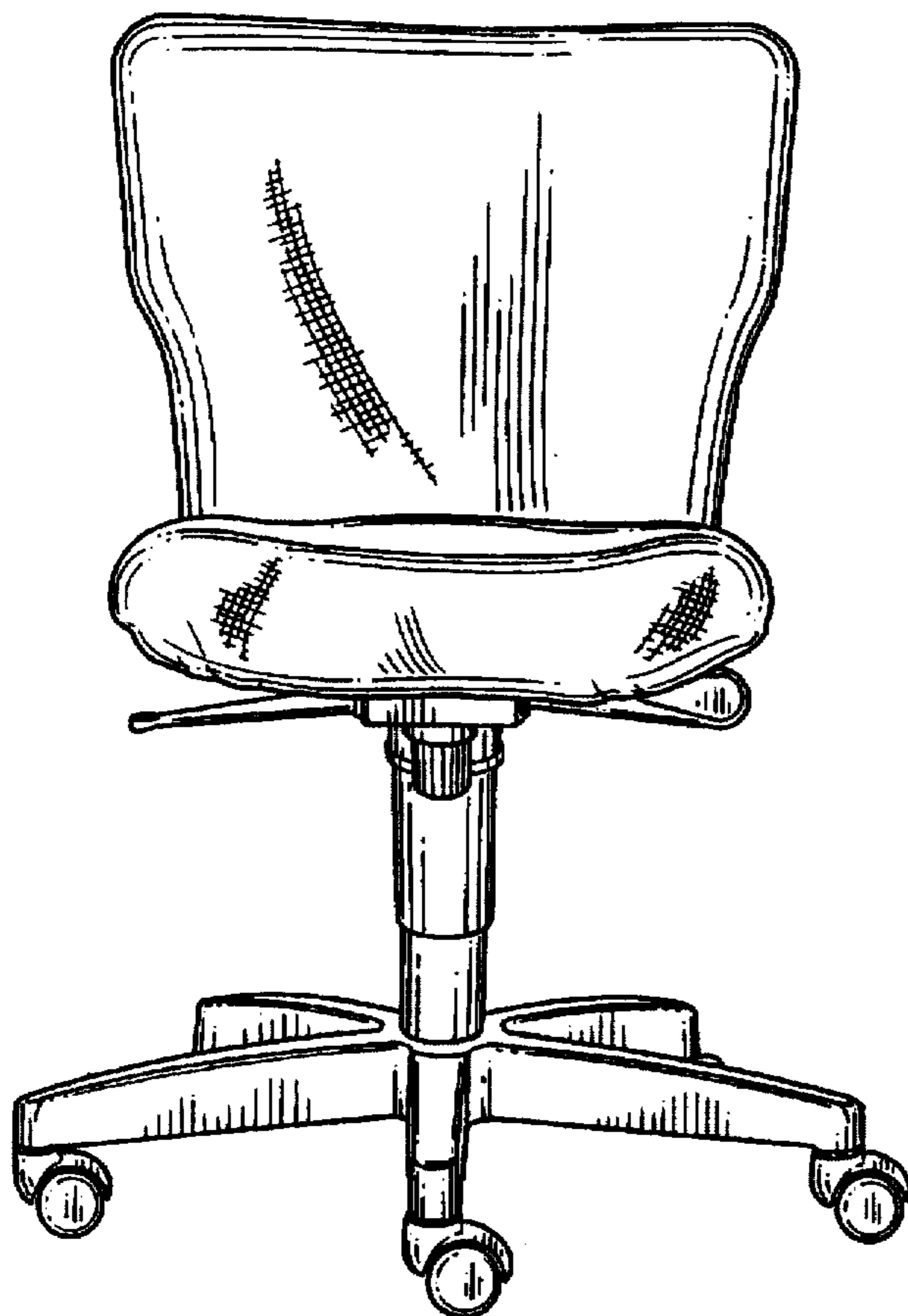

FIG. 1

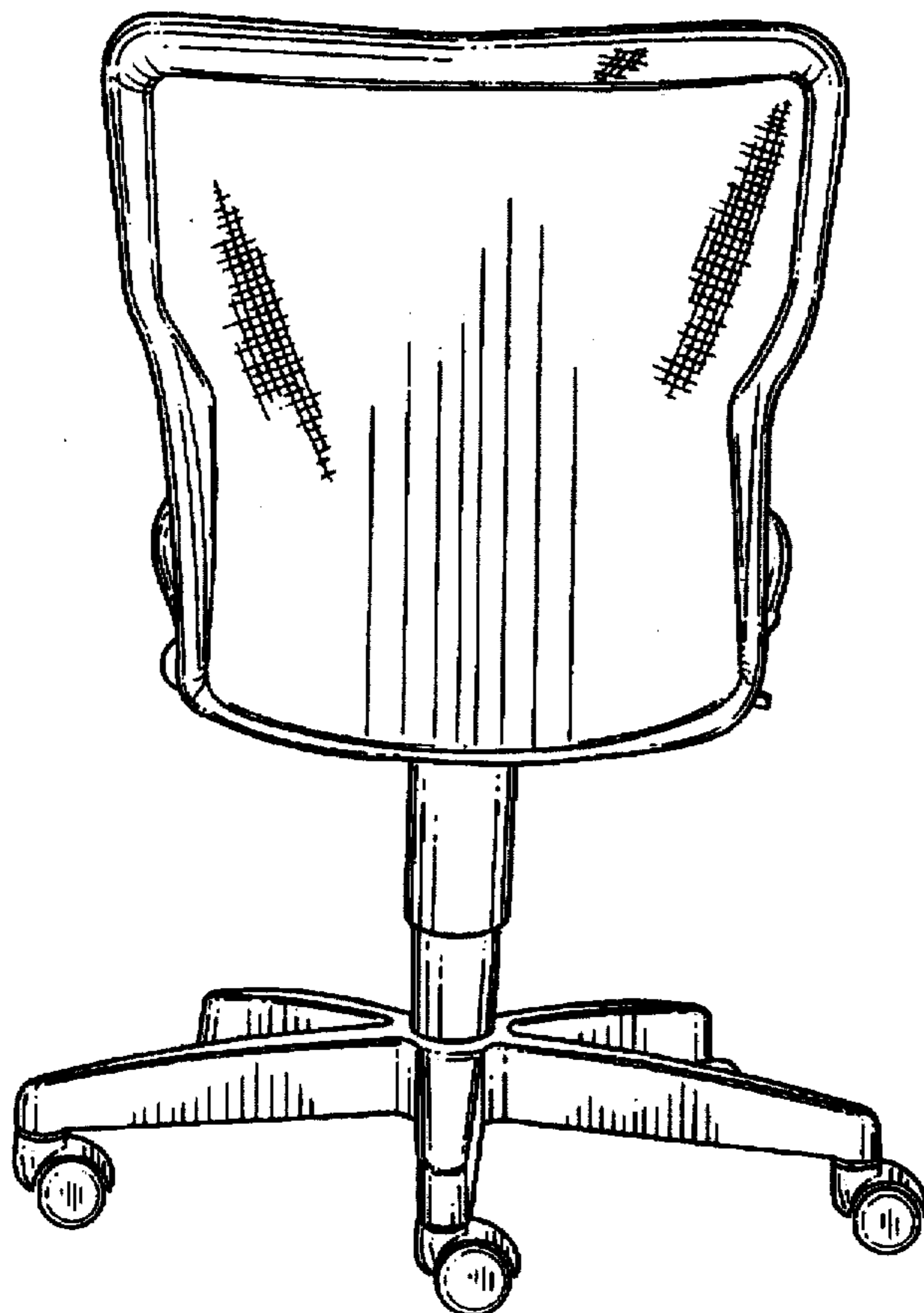

FIG. 2

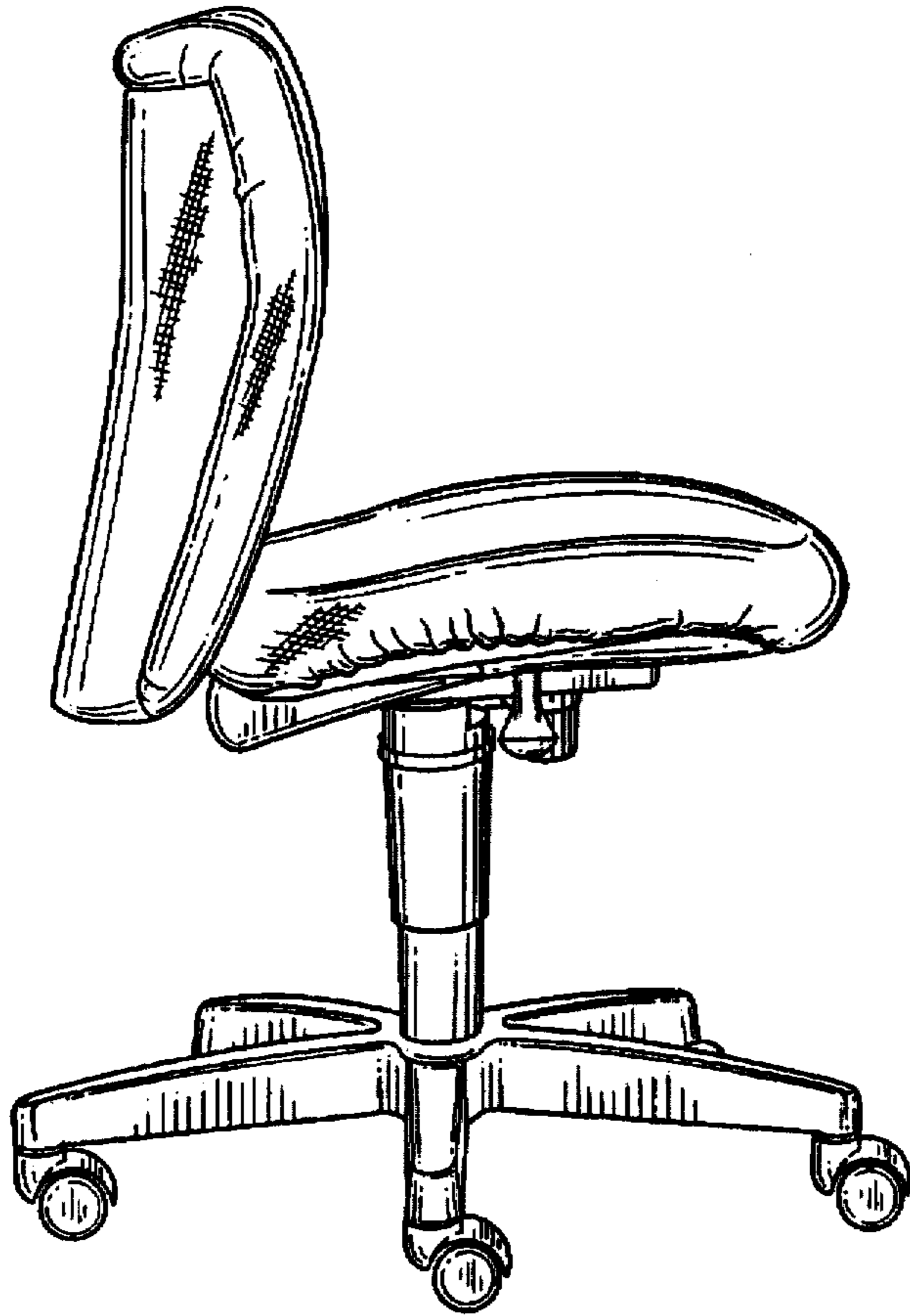

FIG. 3

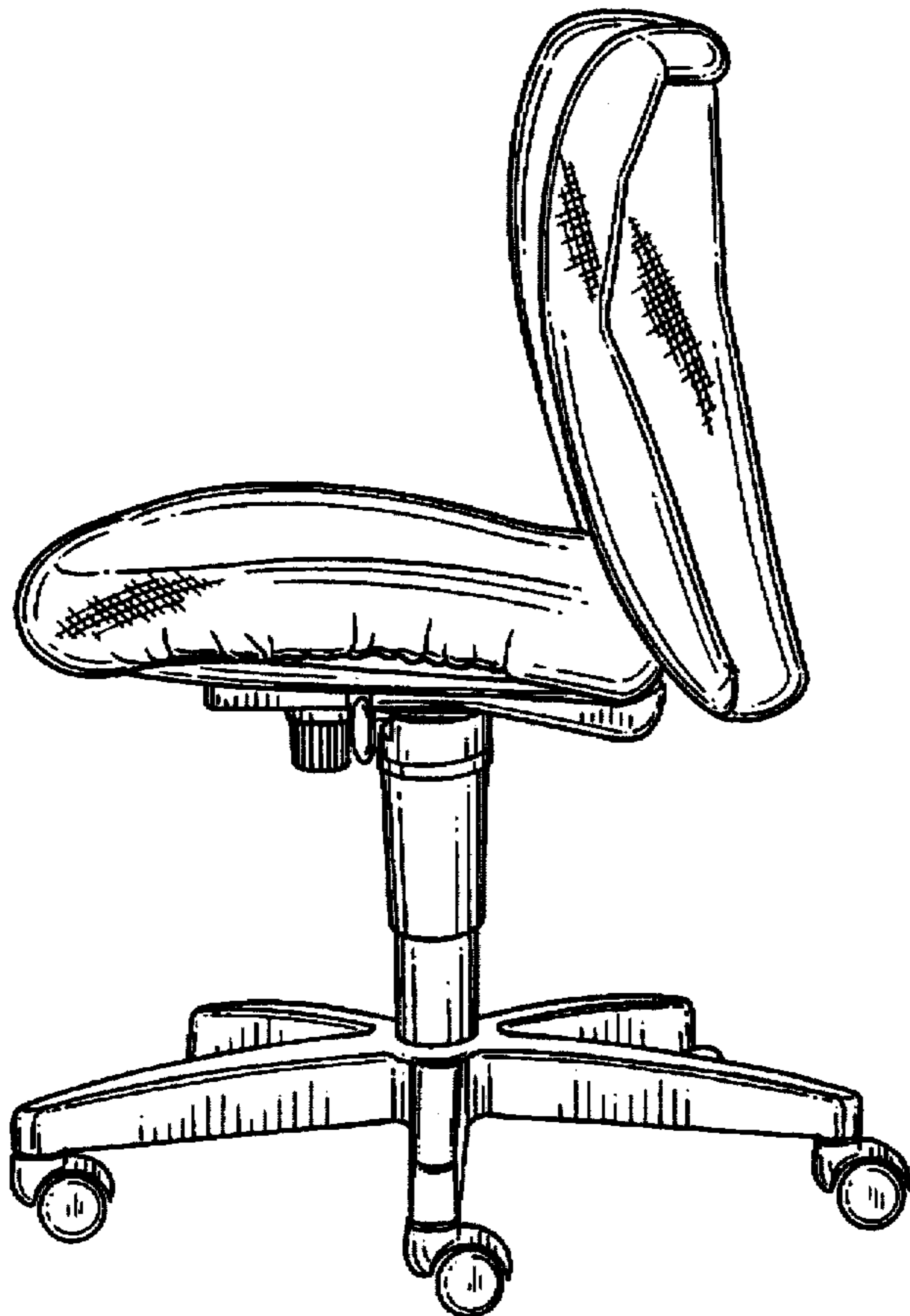

FIG. 4



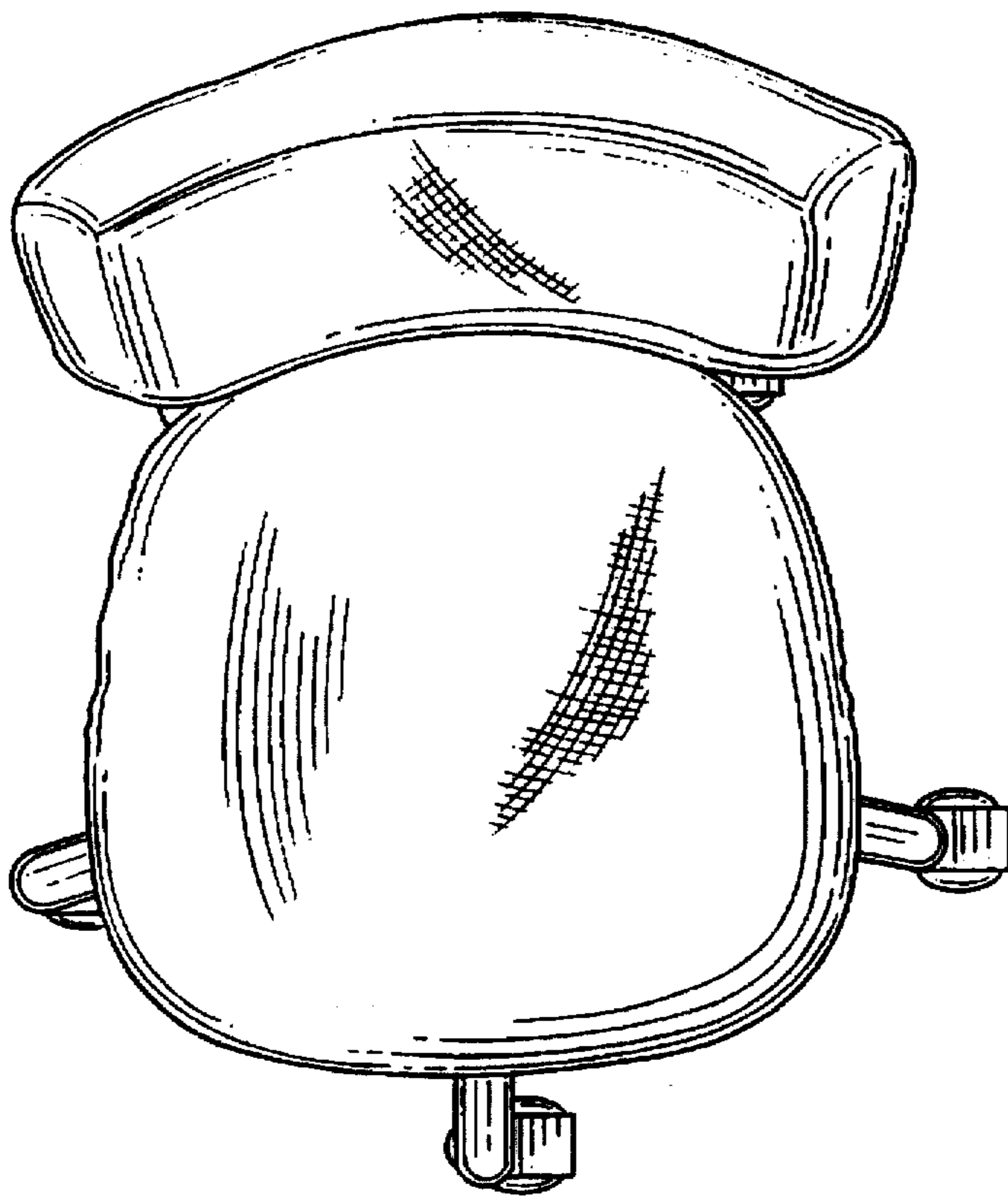

FIG. 5

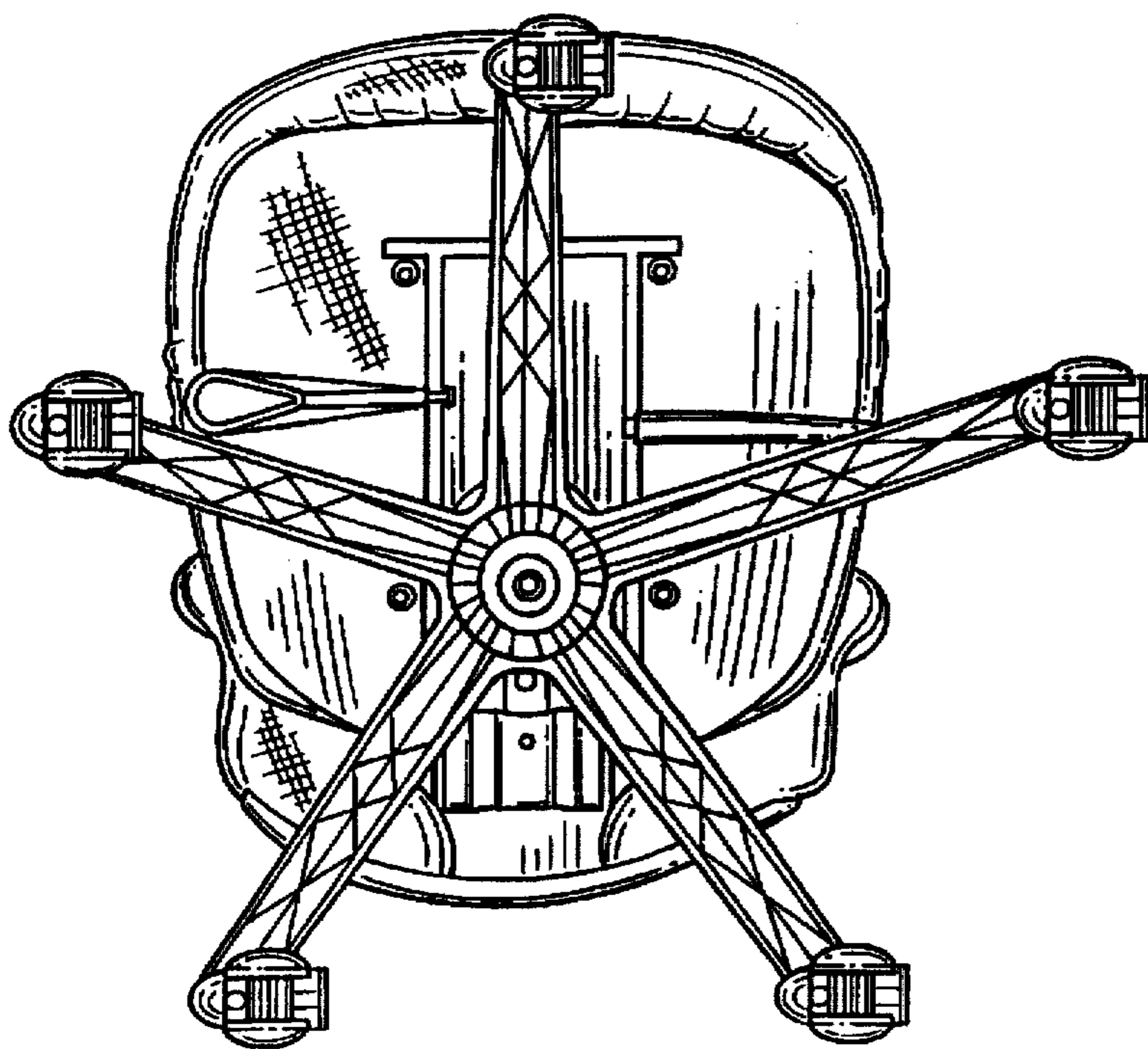

FIG. 6

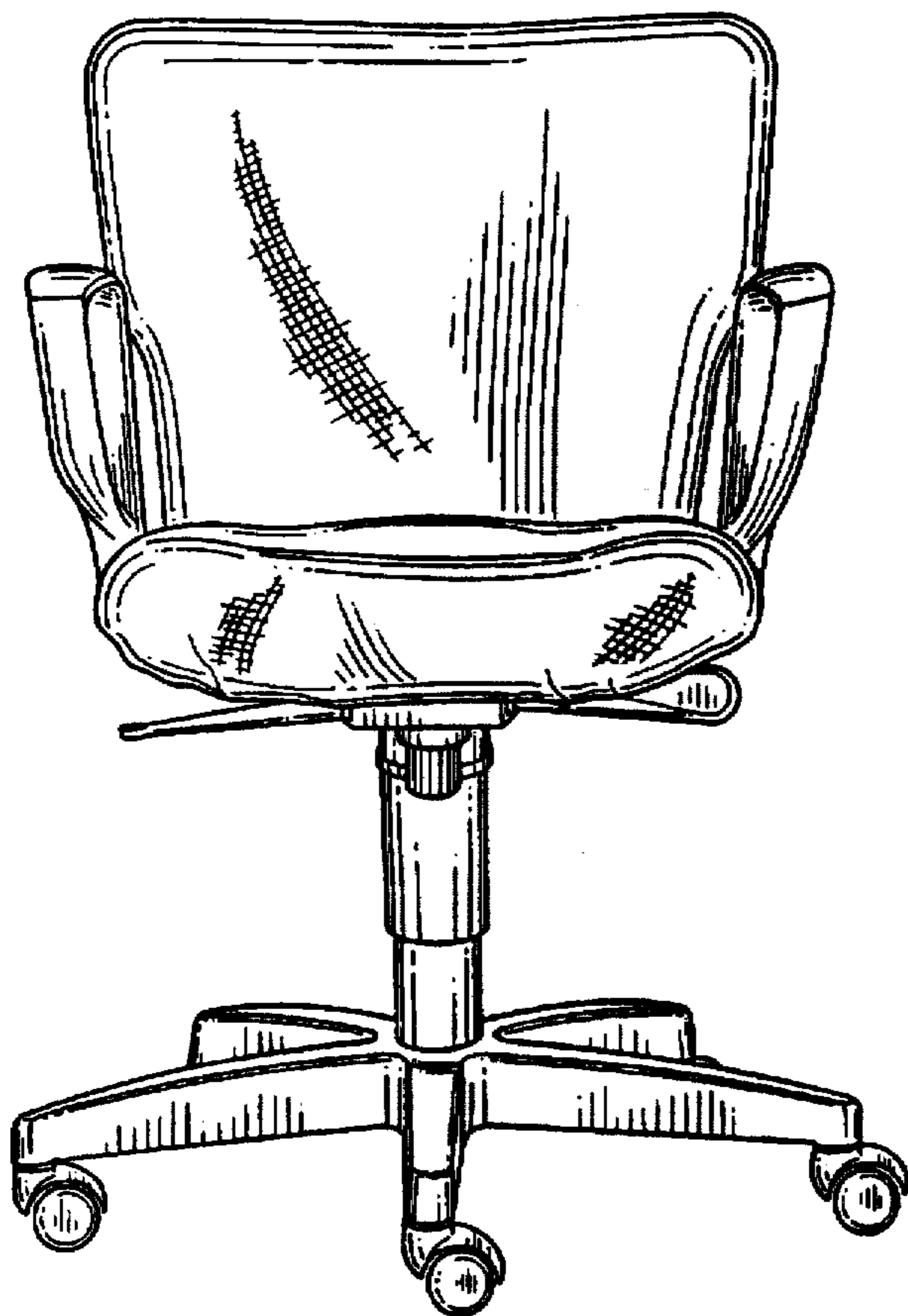

FIG. 7

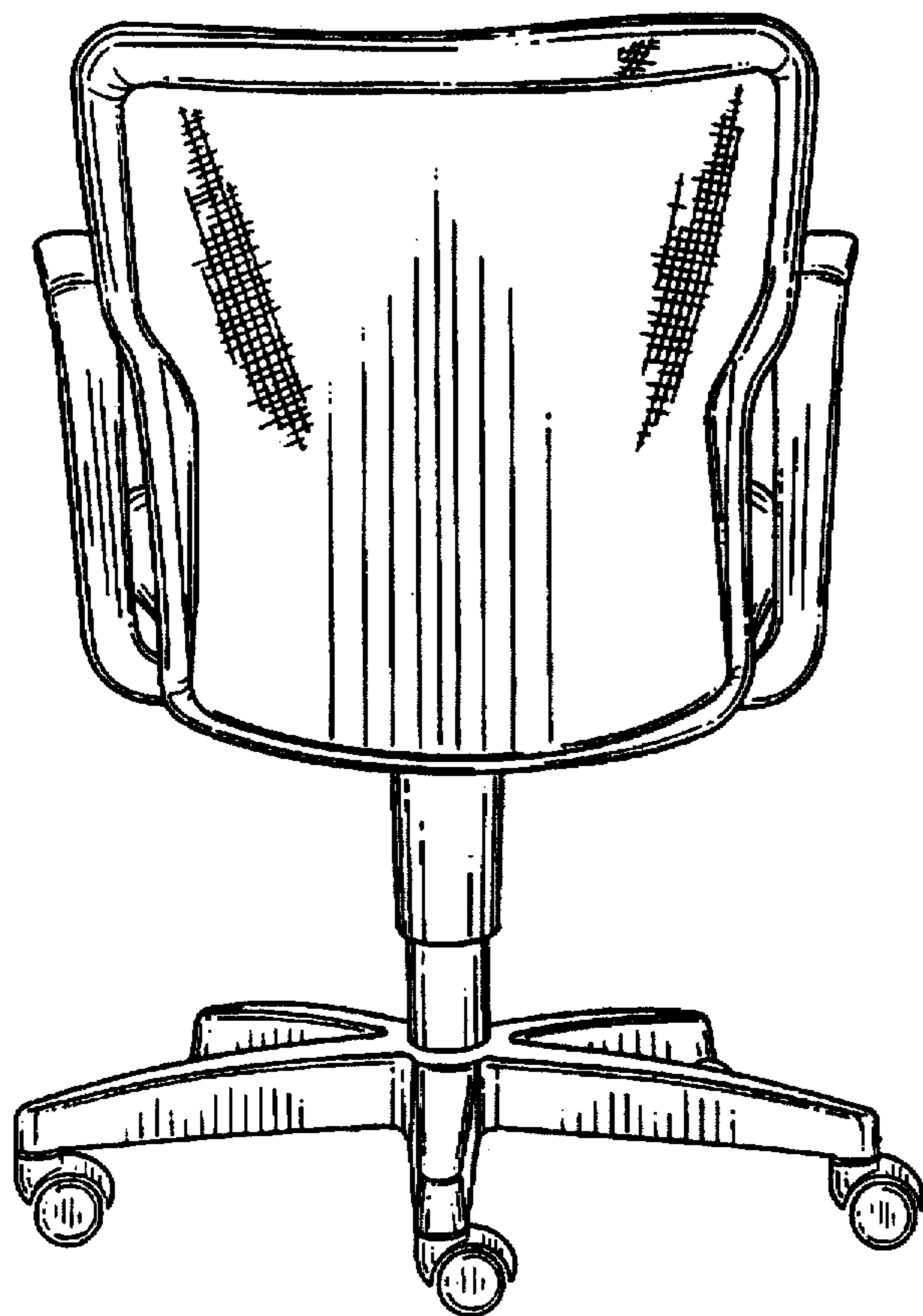

FIG. 8

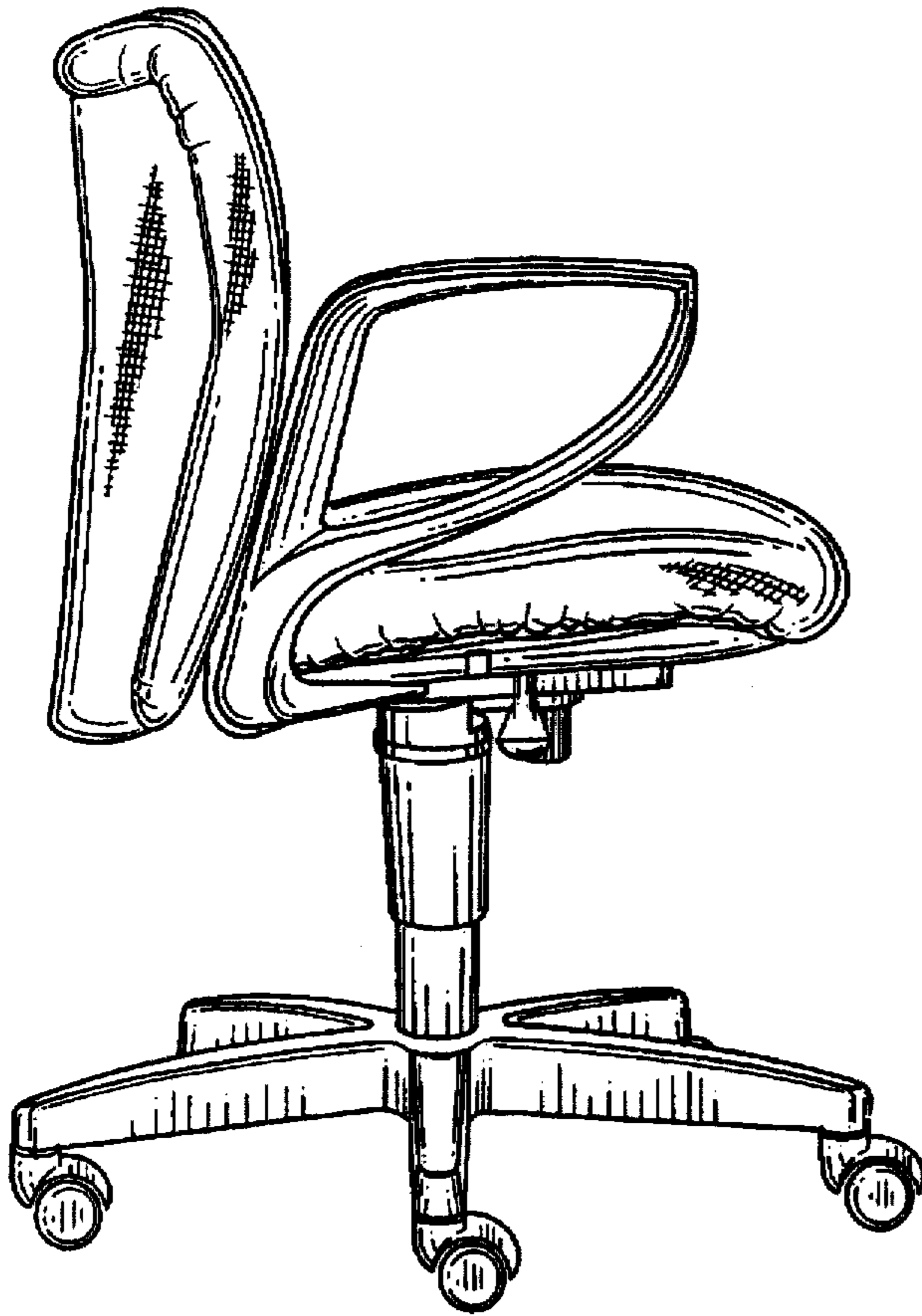

FIG. 9

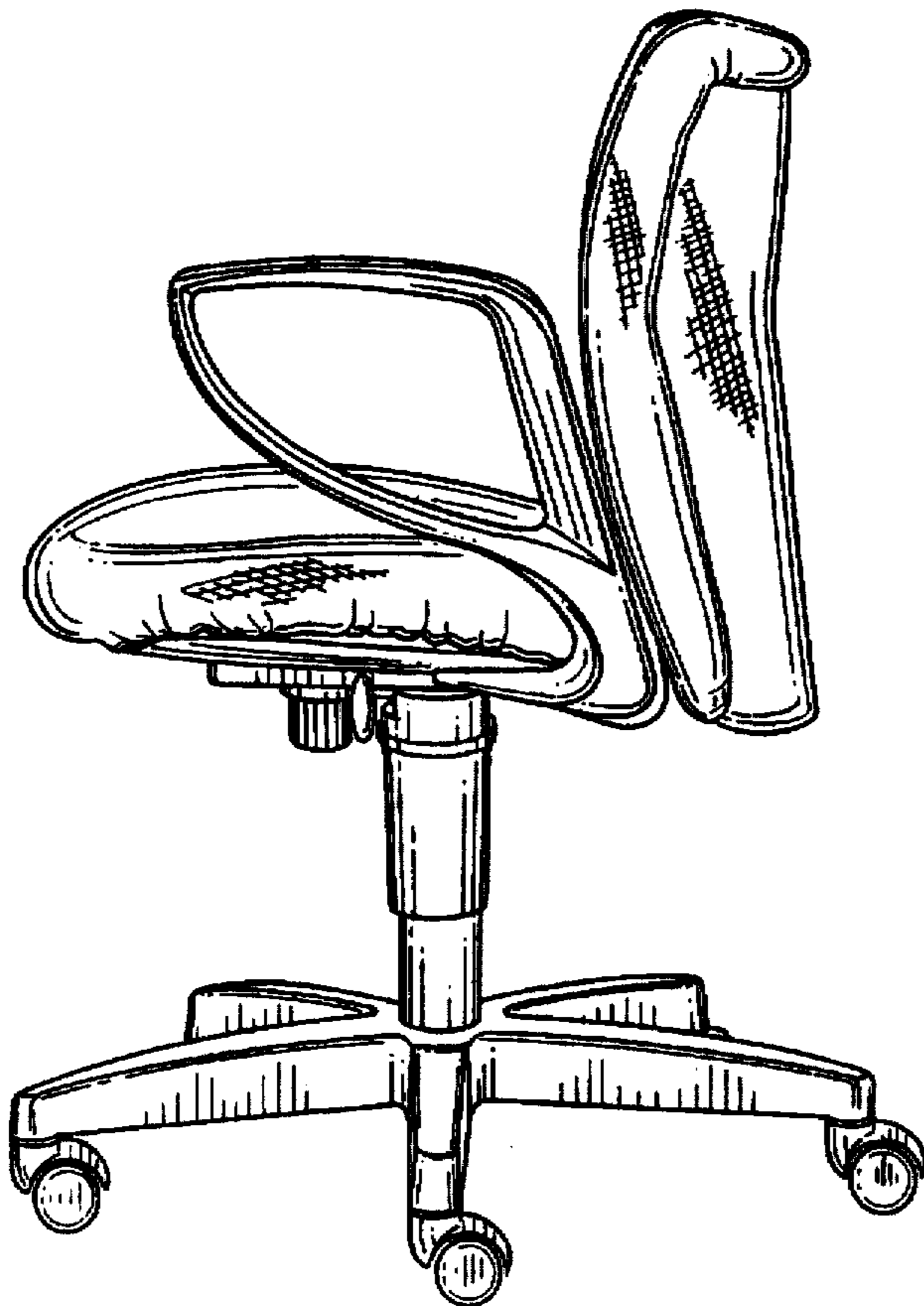

FIG. 10

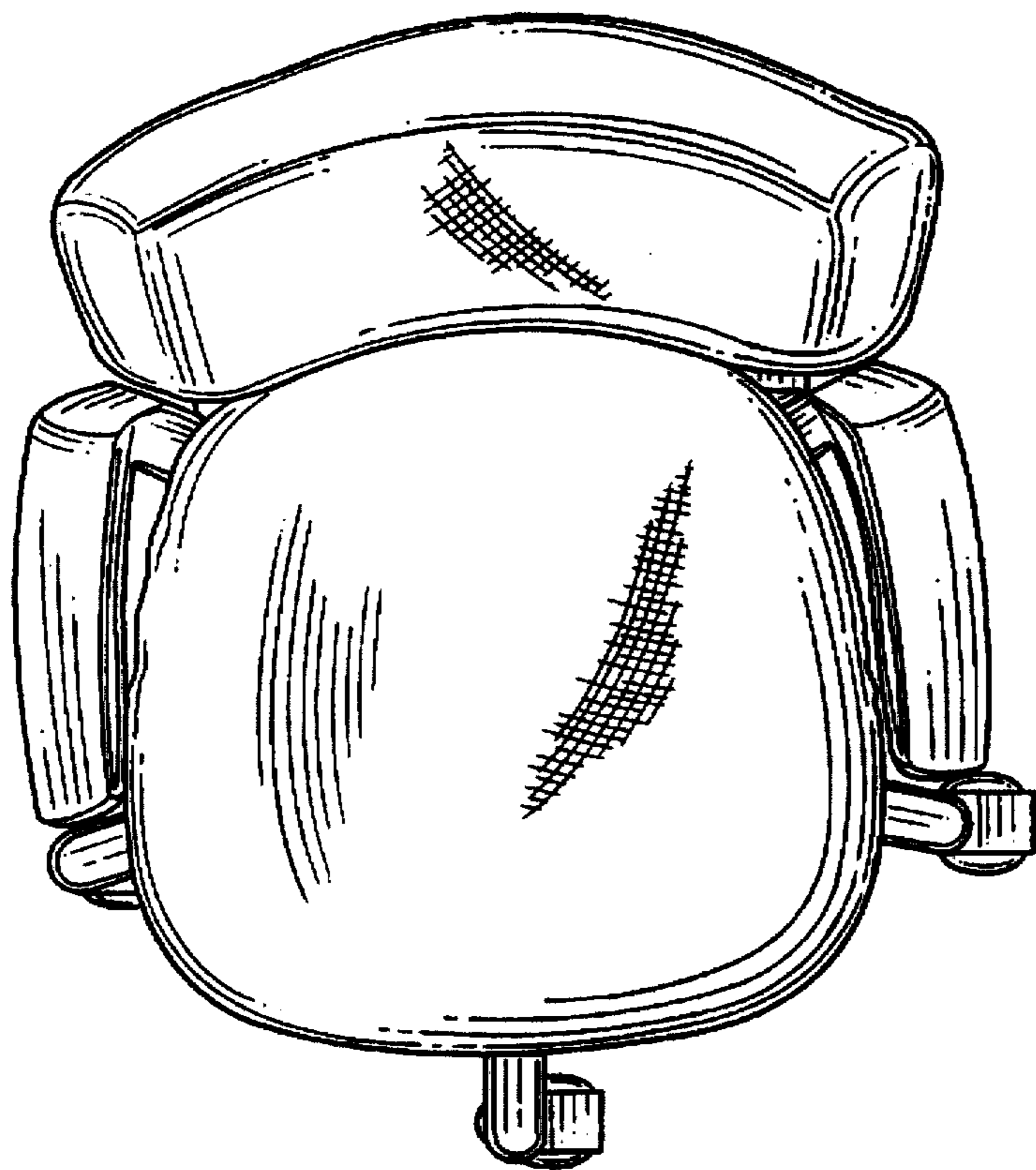

FIG. 11

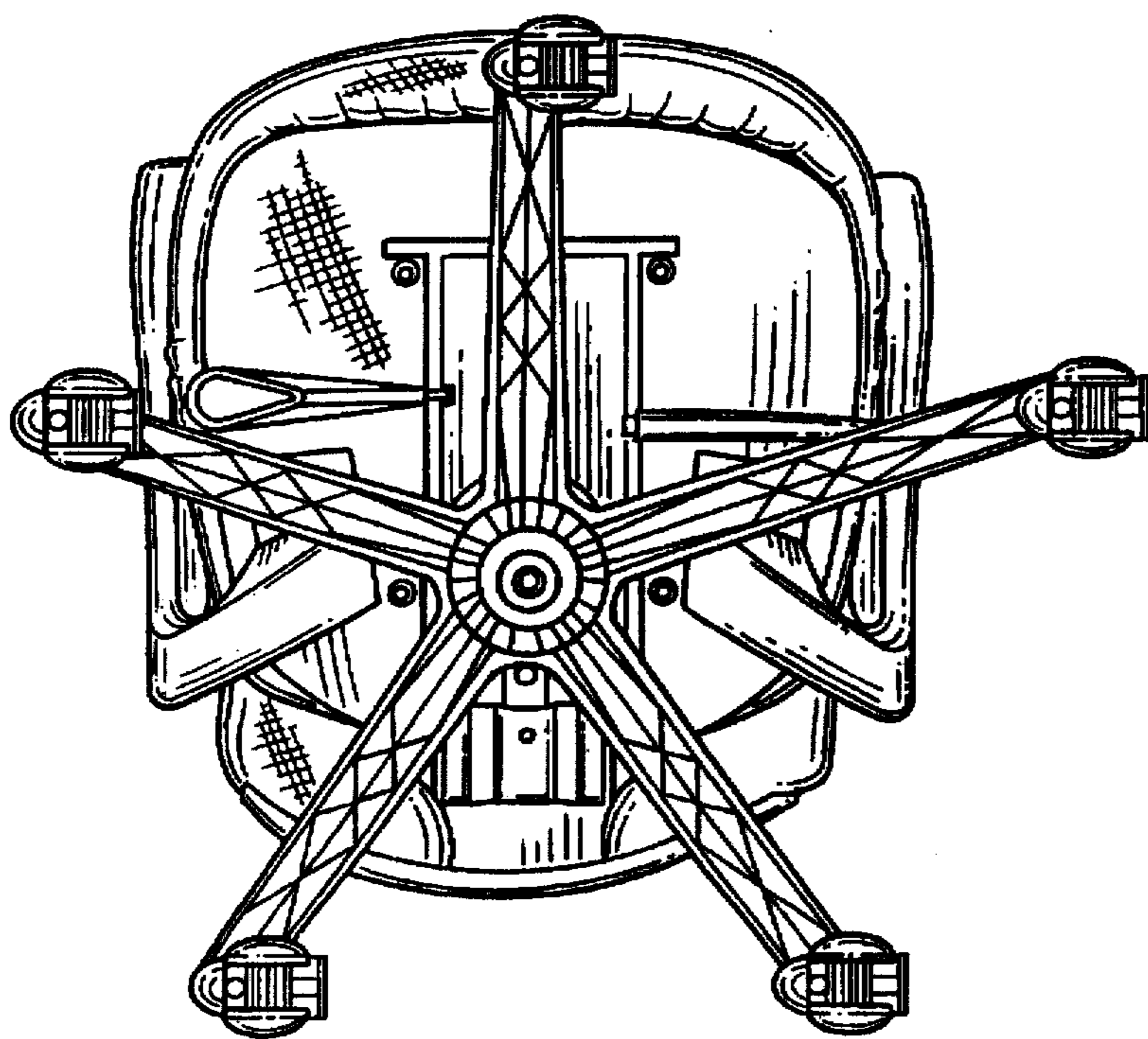

FIG. 12