



US00D388246S

United States Patent [19]

Patterson

[11] Patent Number: Des. 388,246

[45] Date of Patent: **Dec. 30, 1997

[54] PORTABLE KEYBOARD CARRIER

[75] Inventor: Matt T. Patterson, Los Angeles, Calif.

[73] Assignee: Walkabout, Inc., Los Angeles, Calif.

[**] Term: 14 Years

[21] Appl. No.: 60,435

[22] Filed: Sep. 27, 1996

[51] LOC (6) CL 03-01

[52] U.S. Cl. D3/204; D3/215

[58] Field of Search D3/204, 215; 206/314; 224/910, 242, 270, 265

[56] References Cited

U.S. PATENT DOCUMENTS

| | | | | |
|-----------|--------|----------|-------|---------|
| 4,387,839 | 6/1983 | Dranchak | | 224/910 |
| 4,450,993 | 5/1984 | Ephraim | | 224/265 |
| 4,605,144 | 8/1986 | LaFlame | | 224/265 |
| 5,186,375 | 2/1993 | Plonk | | 224/270 |

Primary Examiner—Celia Murphy
Attorney, Agent, or Firm—Snell & Wilmer LLP

[57] CLAIM

The ornamental design for the portable keyboard carrier, as shown and described.

DESCRIPTION

FIG. 1 is a front right perspective view of a portable keyboard carrier showing my new design, the left perspective view being a mirror image;
 FIG. 2 is a front elevational view thereof;
 FIG. 3 is a rear elevational view thereof;
 FIG. 4 is a right side elevational view thereof;
 FIG. 5 is a top plan view thereof;
 FIG. 6 is a bottom plan view thereof;
 FIG. 7 is a front right perspective view of an alternate embodiment of the design shown in FIG. 1, the left perspective view being a mirror image;
 FIG. 8 is a front elevational view of FIG. 7;
 FIG. 9 is a rear elevational view of FIG. 7;
 FIG. 10 is a right side elevational view of FIG. 7;
 FIG. 11 is a top plan view of FIG. 7; and,
 FIG. 12 is a bottom plan view of FIG. 7.

1 Claim, 4 Drawing Sheets

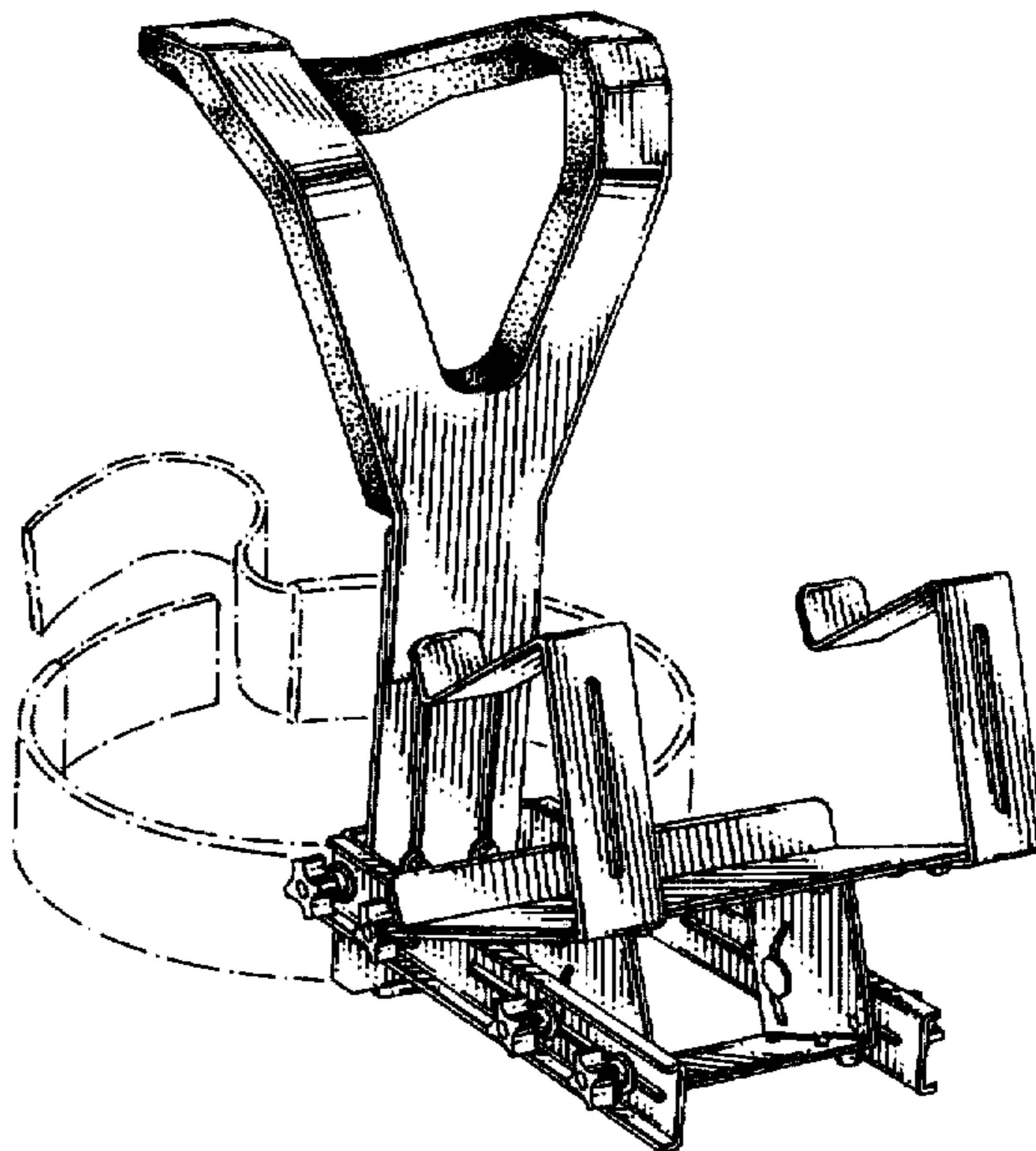
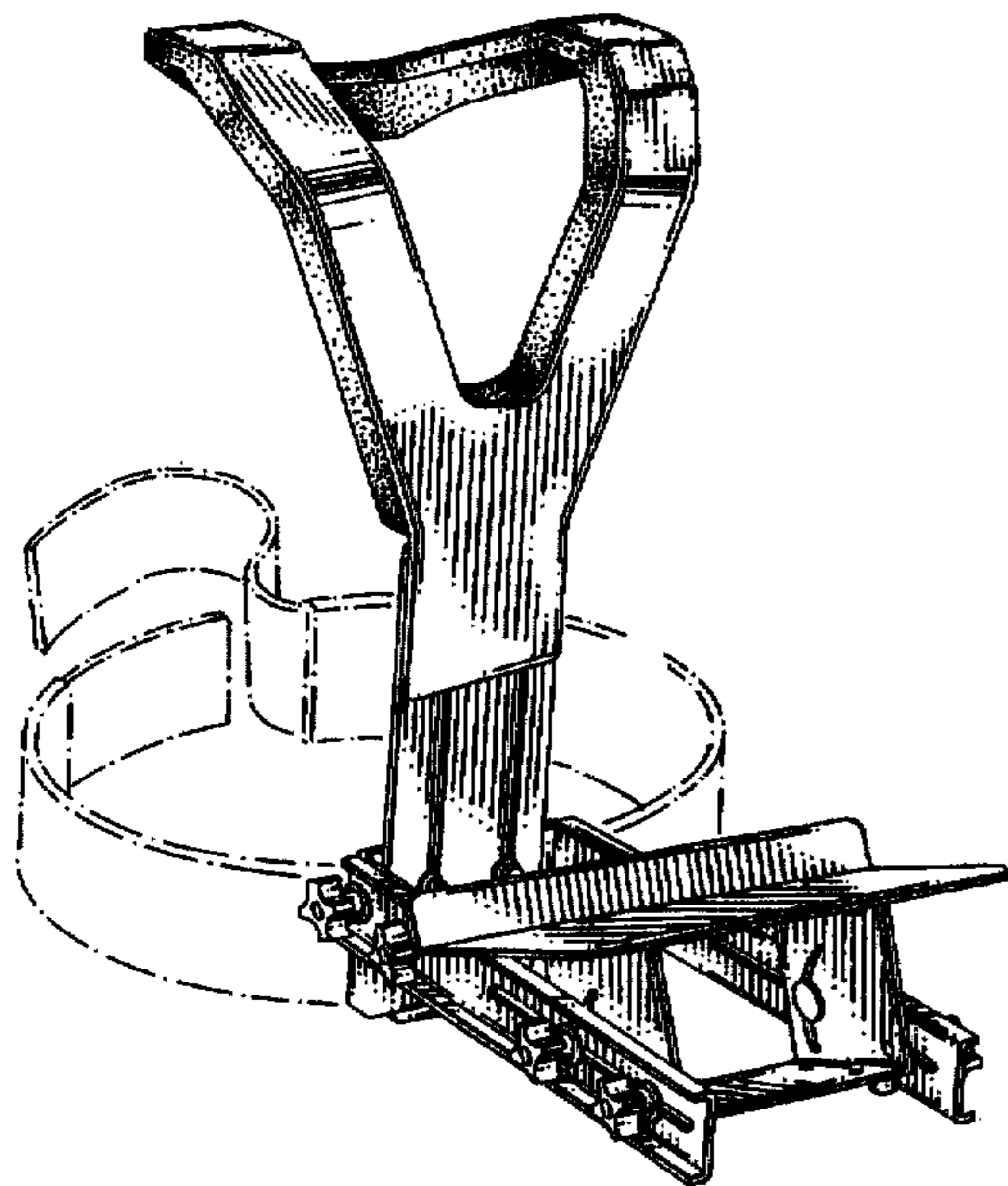

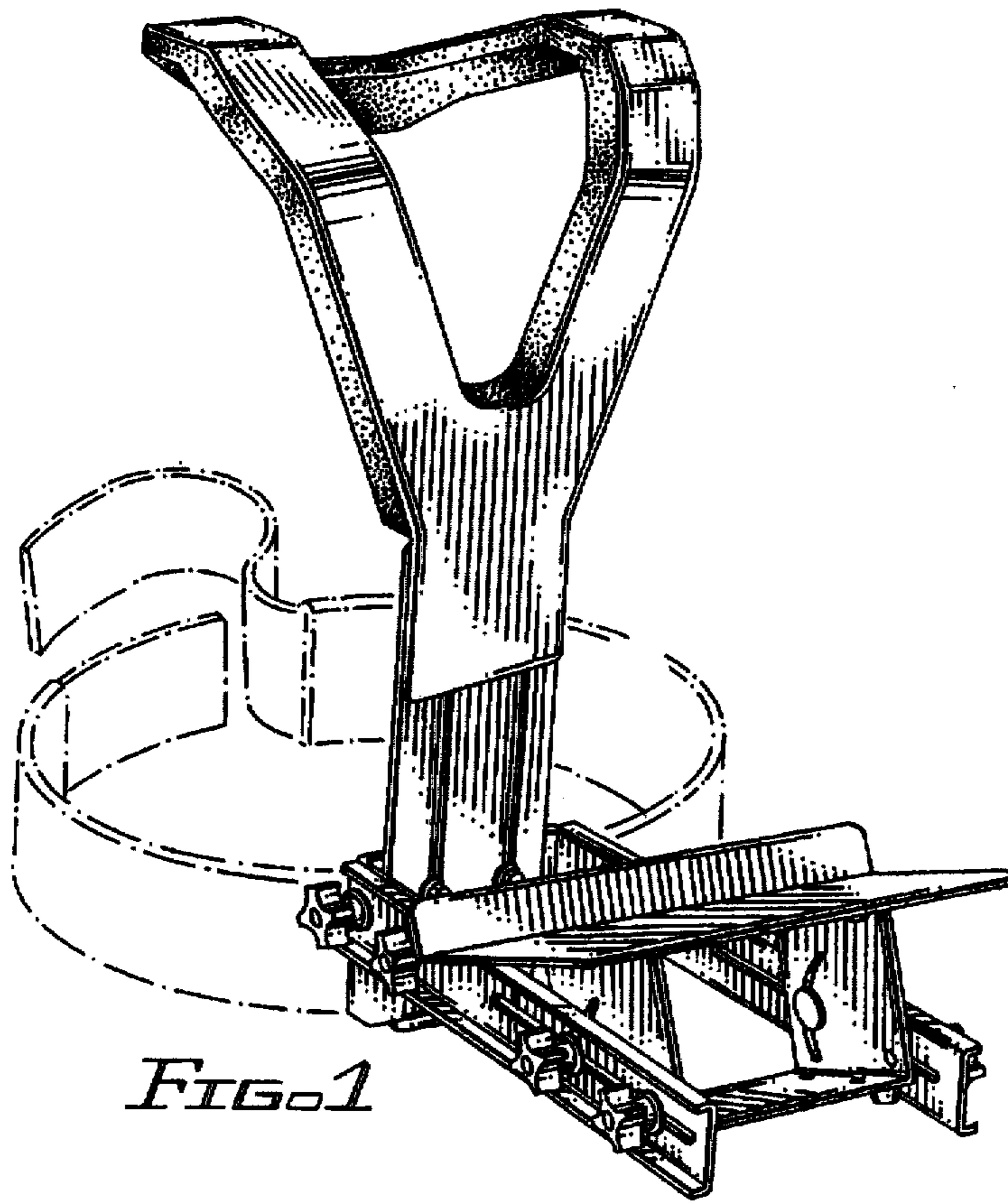

FIG. 1

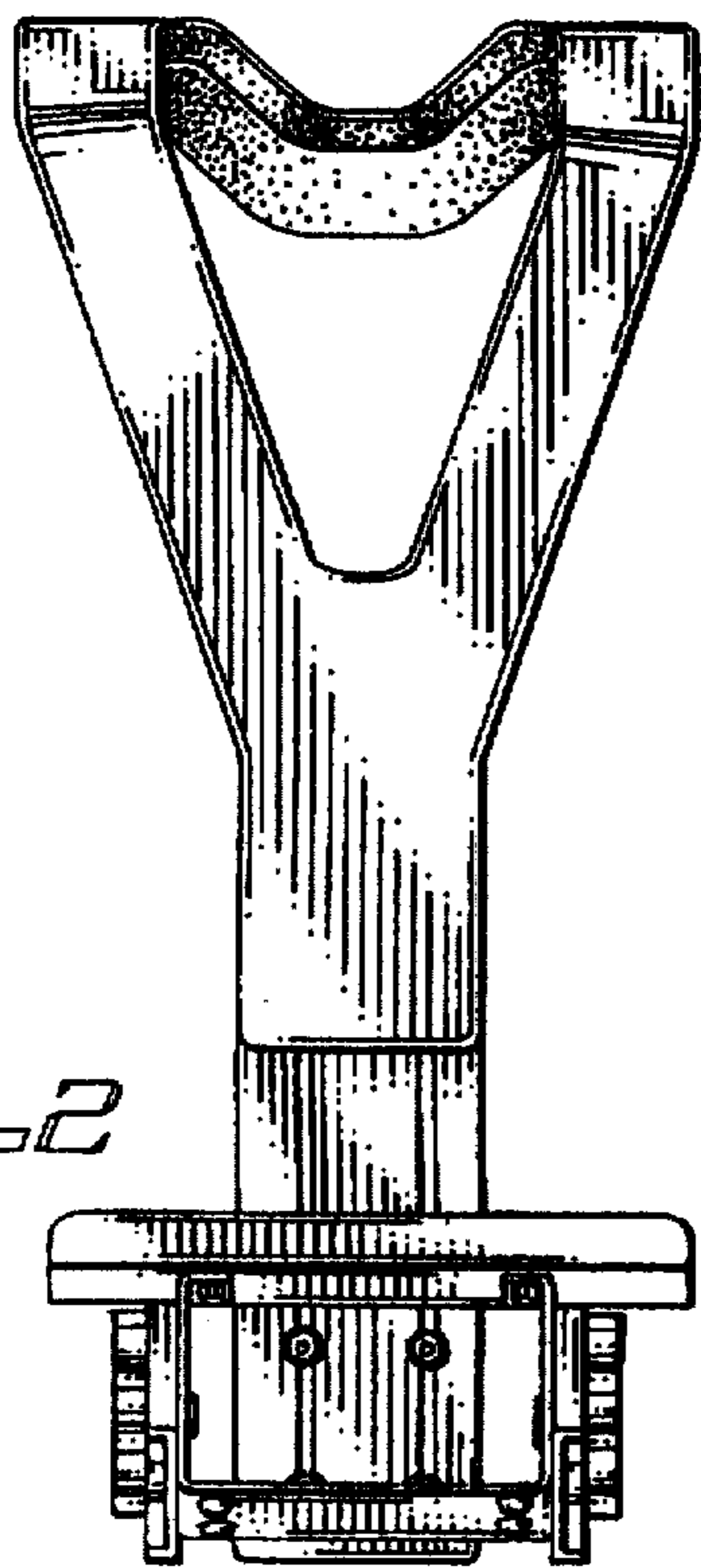

FIG. 2

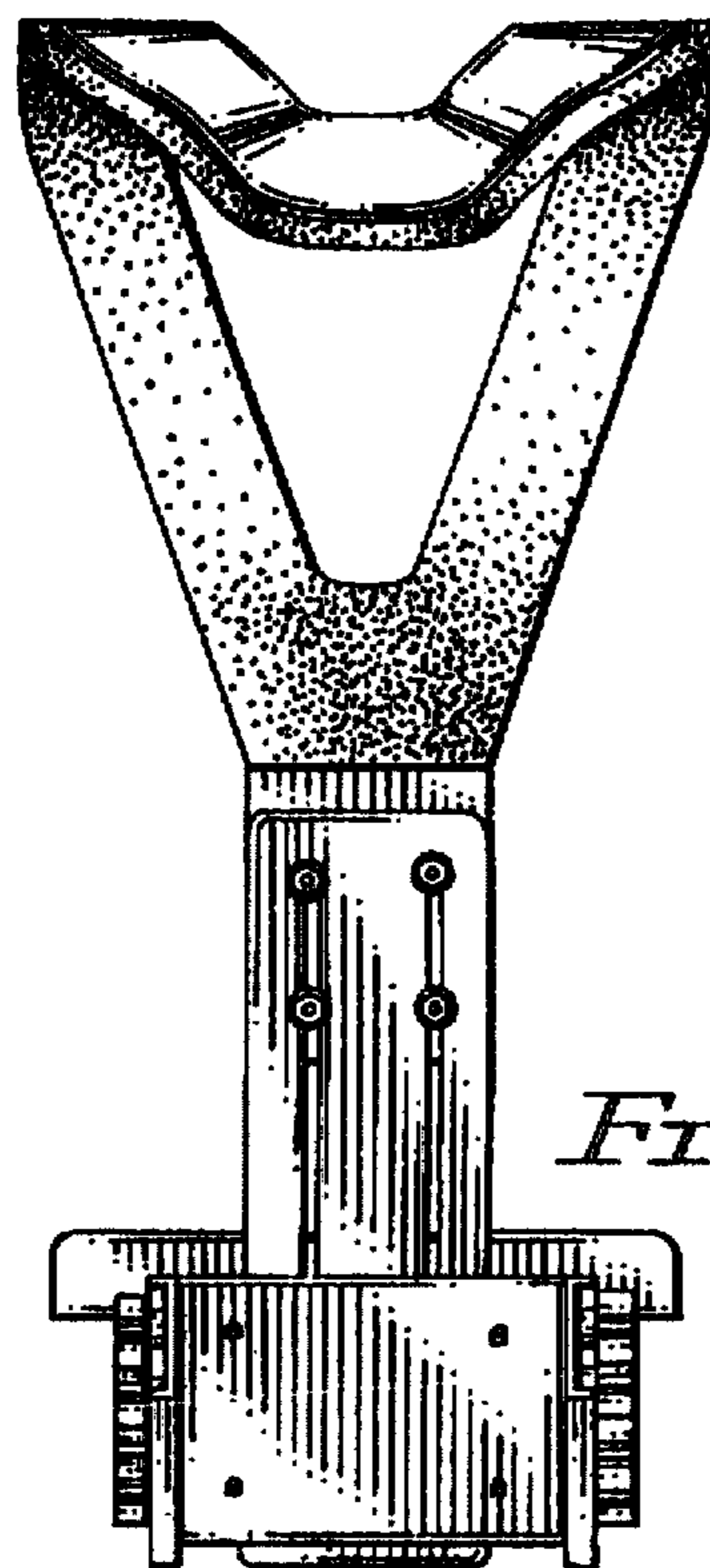

FIG. 3

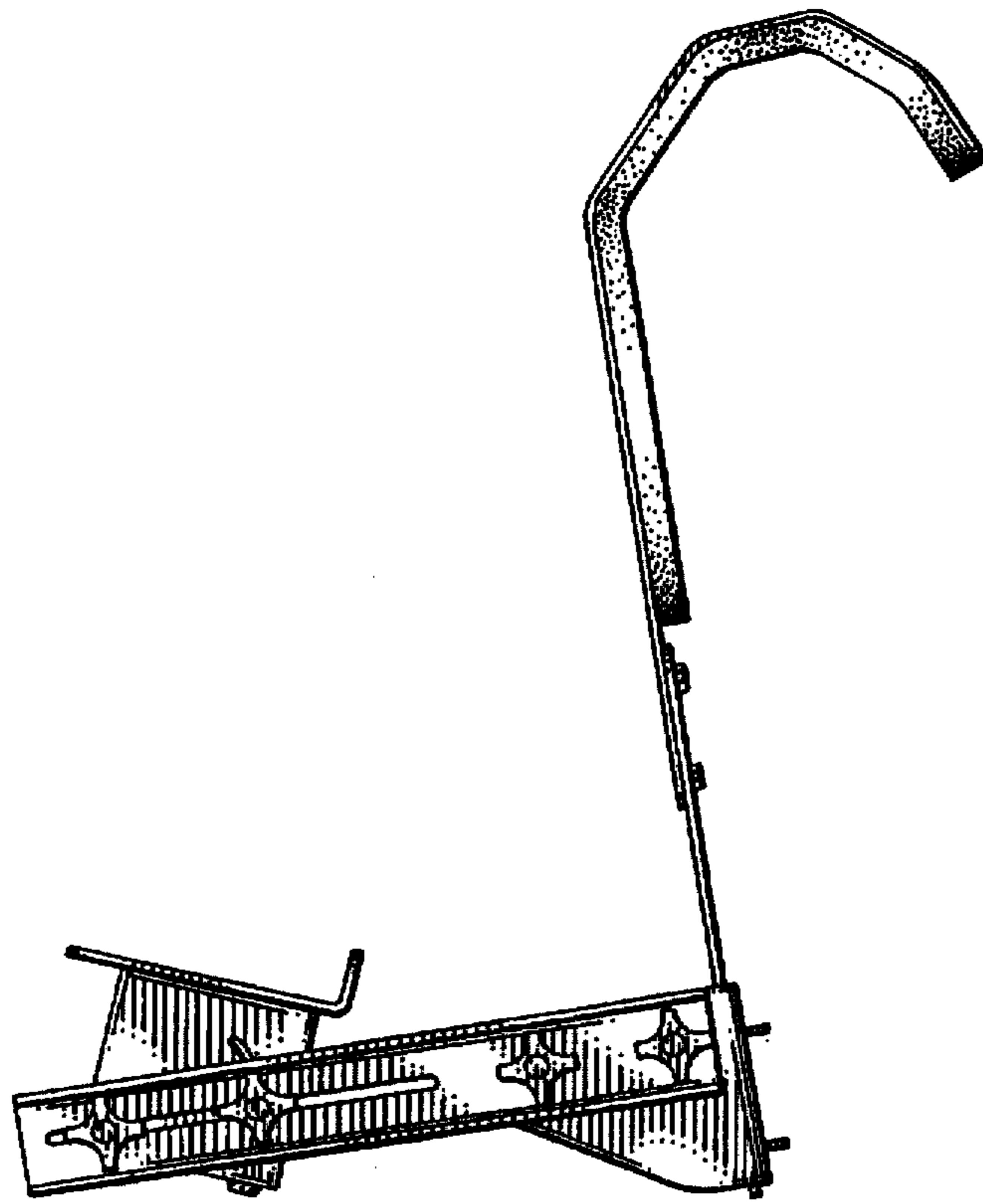

FIG. 4

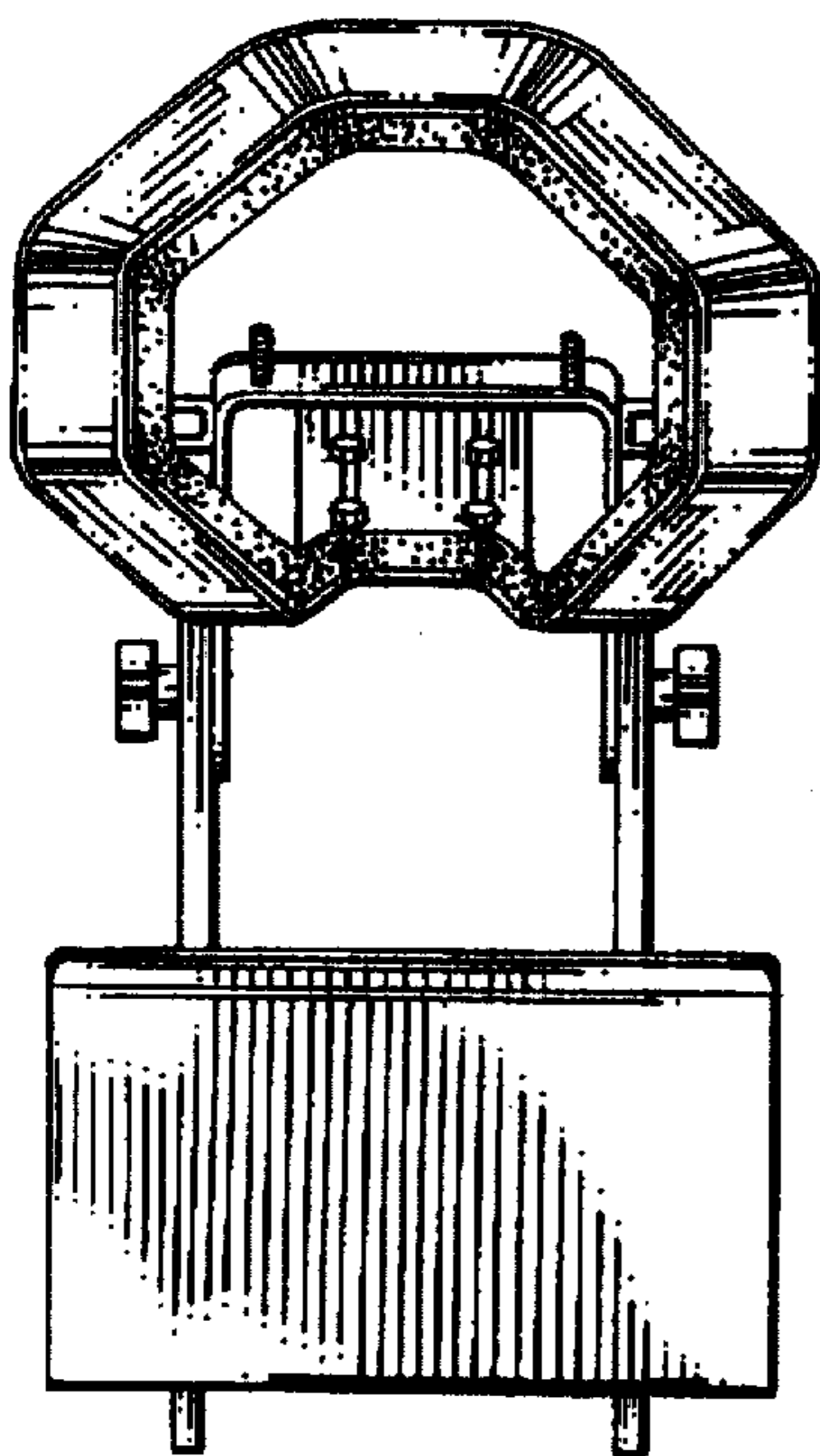

FIG. 5

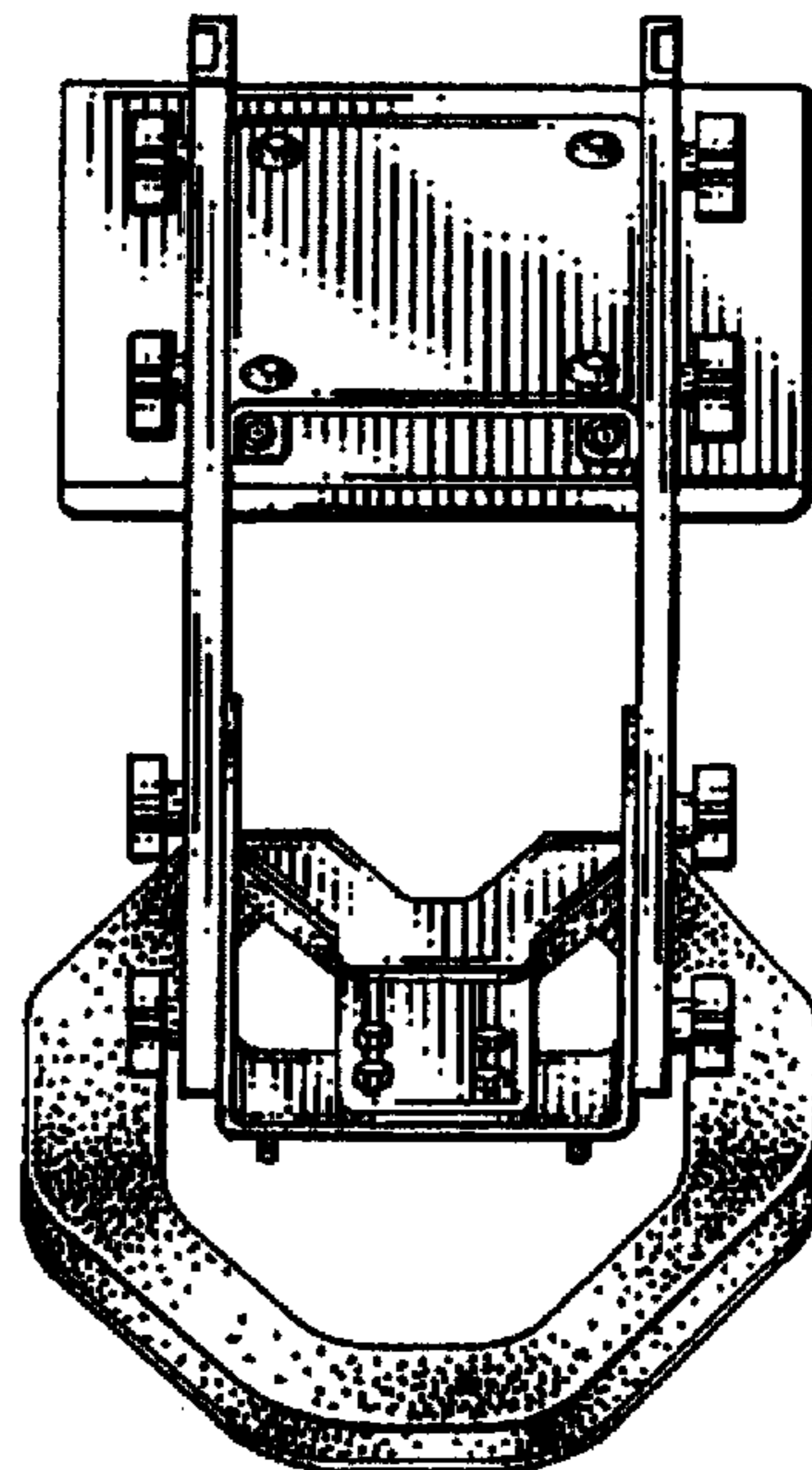

FIG. 6

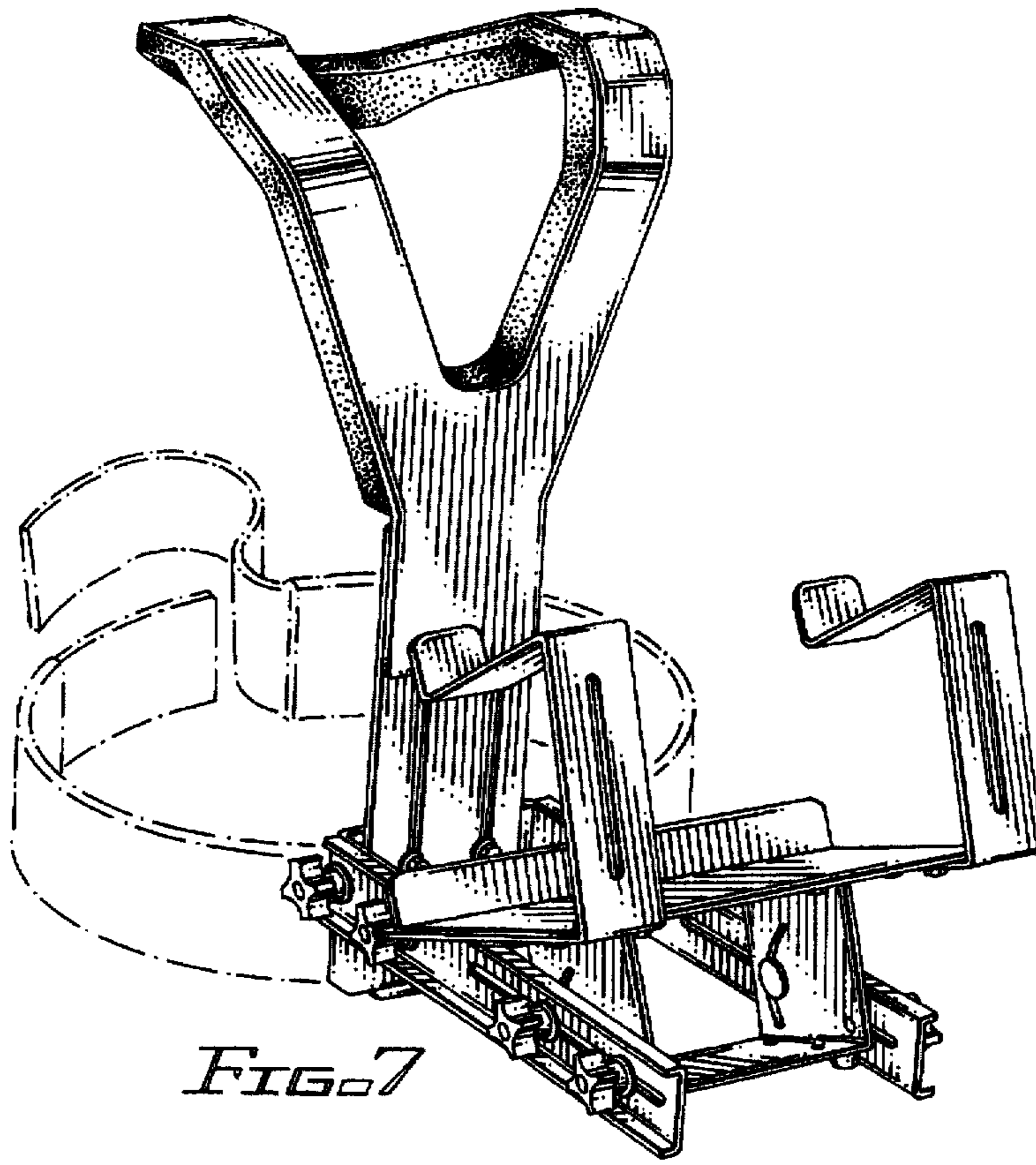

FIG. 7

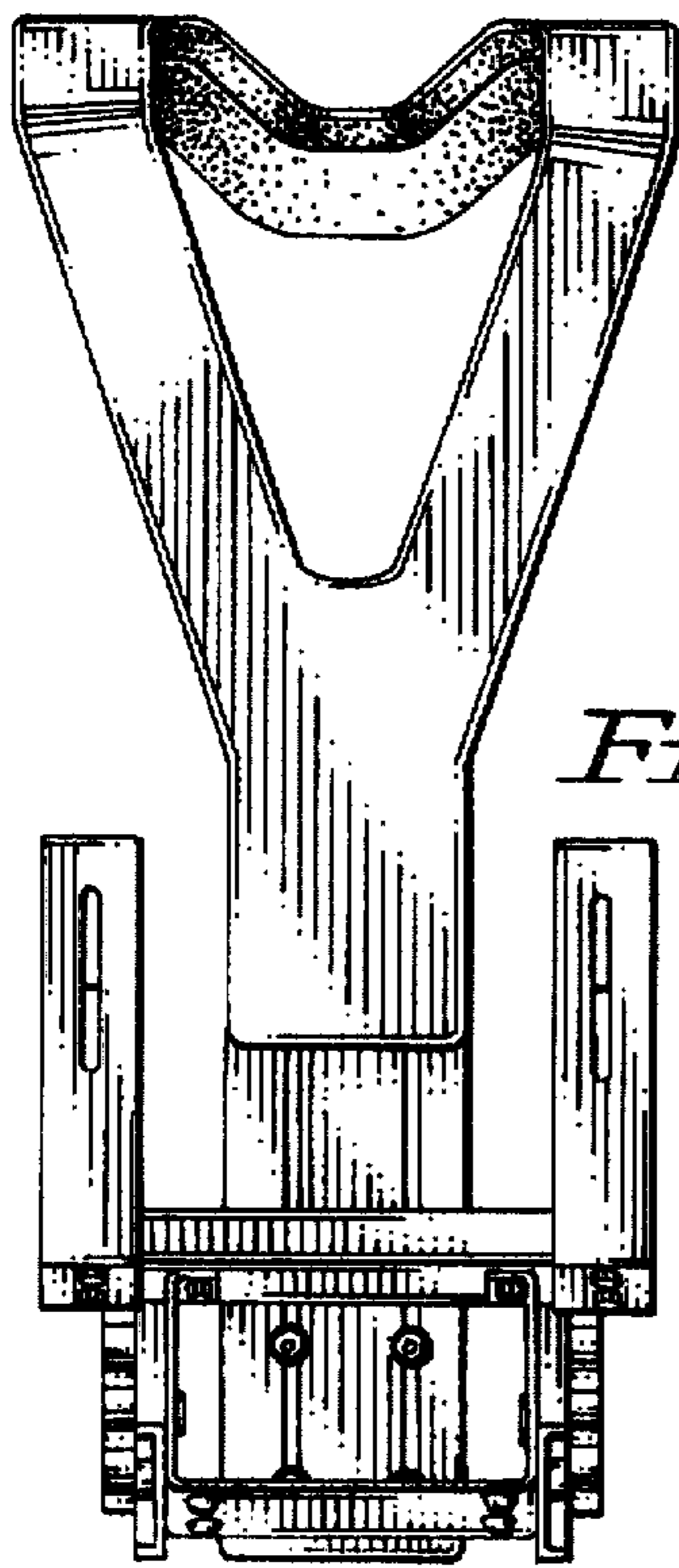

FIG. 8

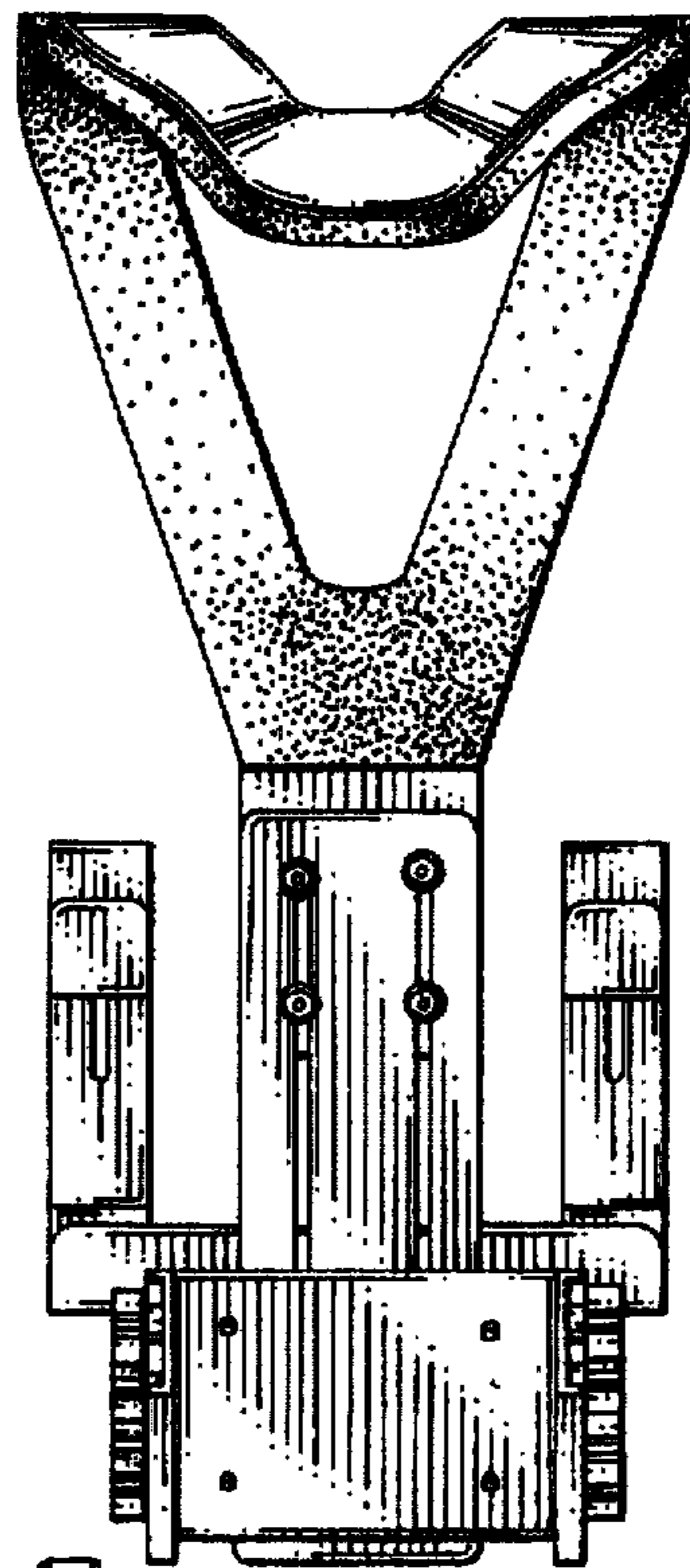

FIG. 9

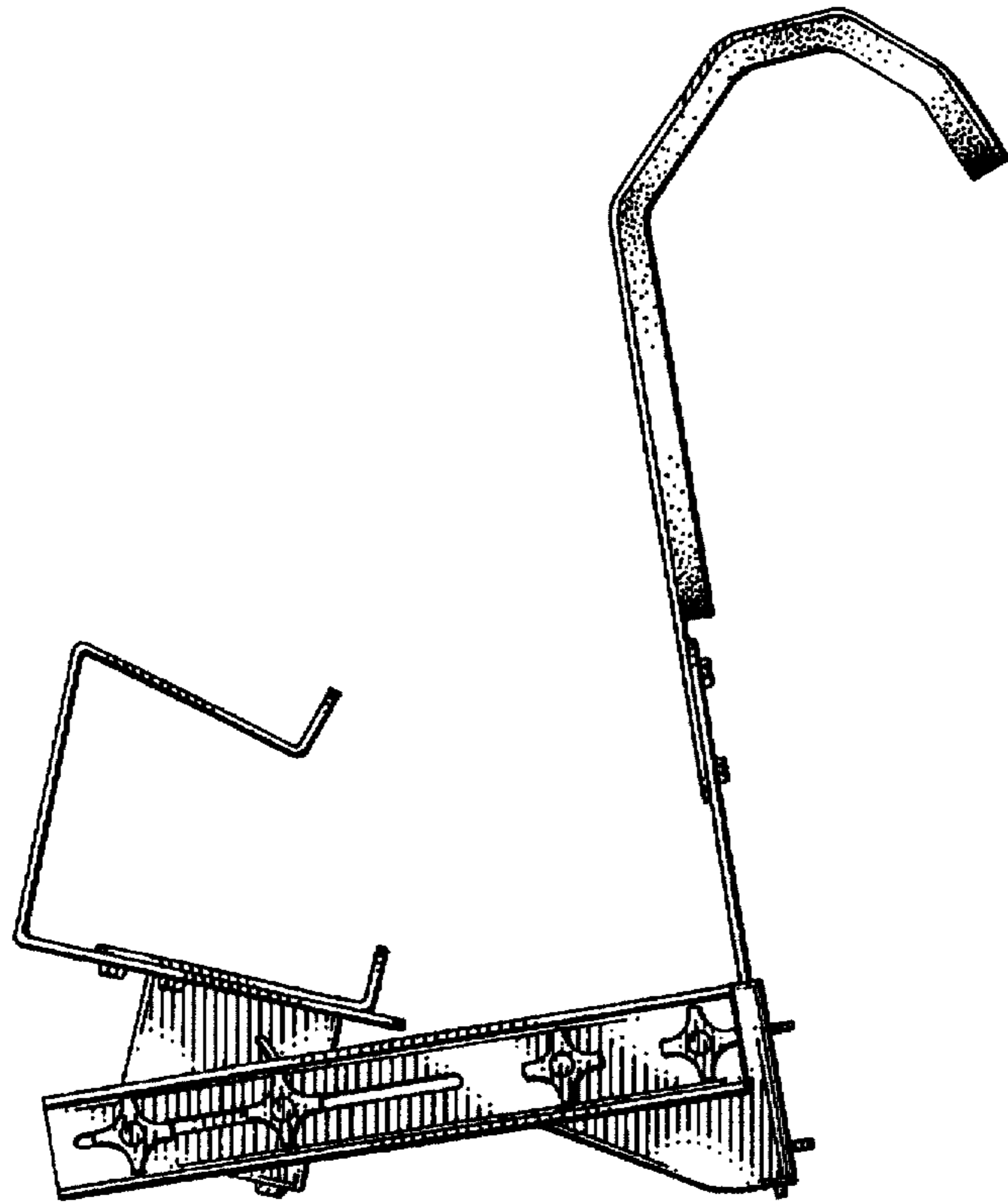

FIG. 10

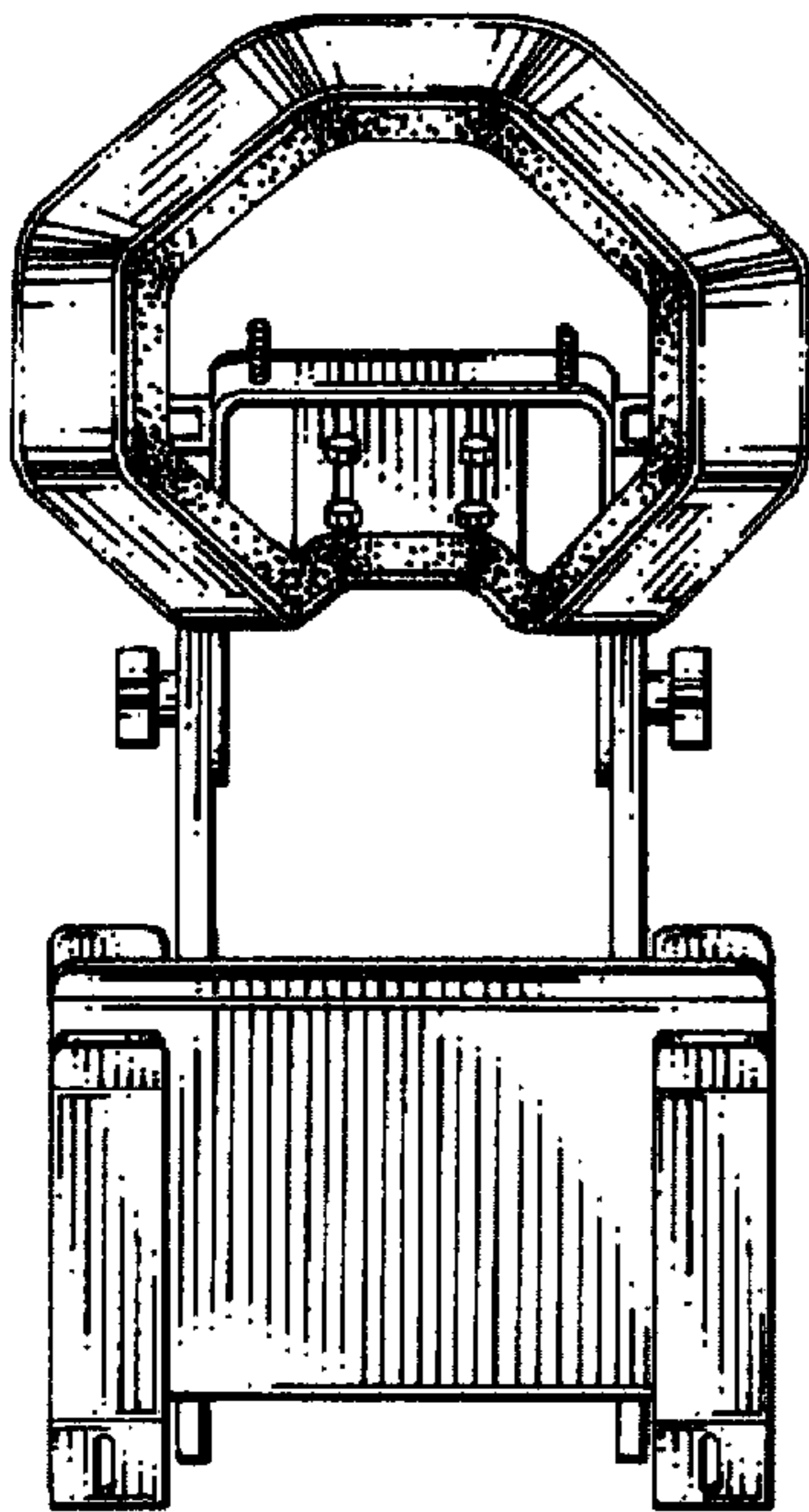

FIG. 11

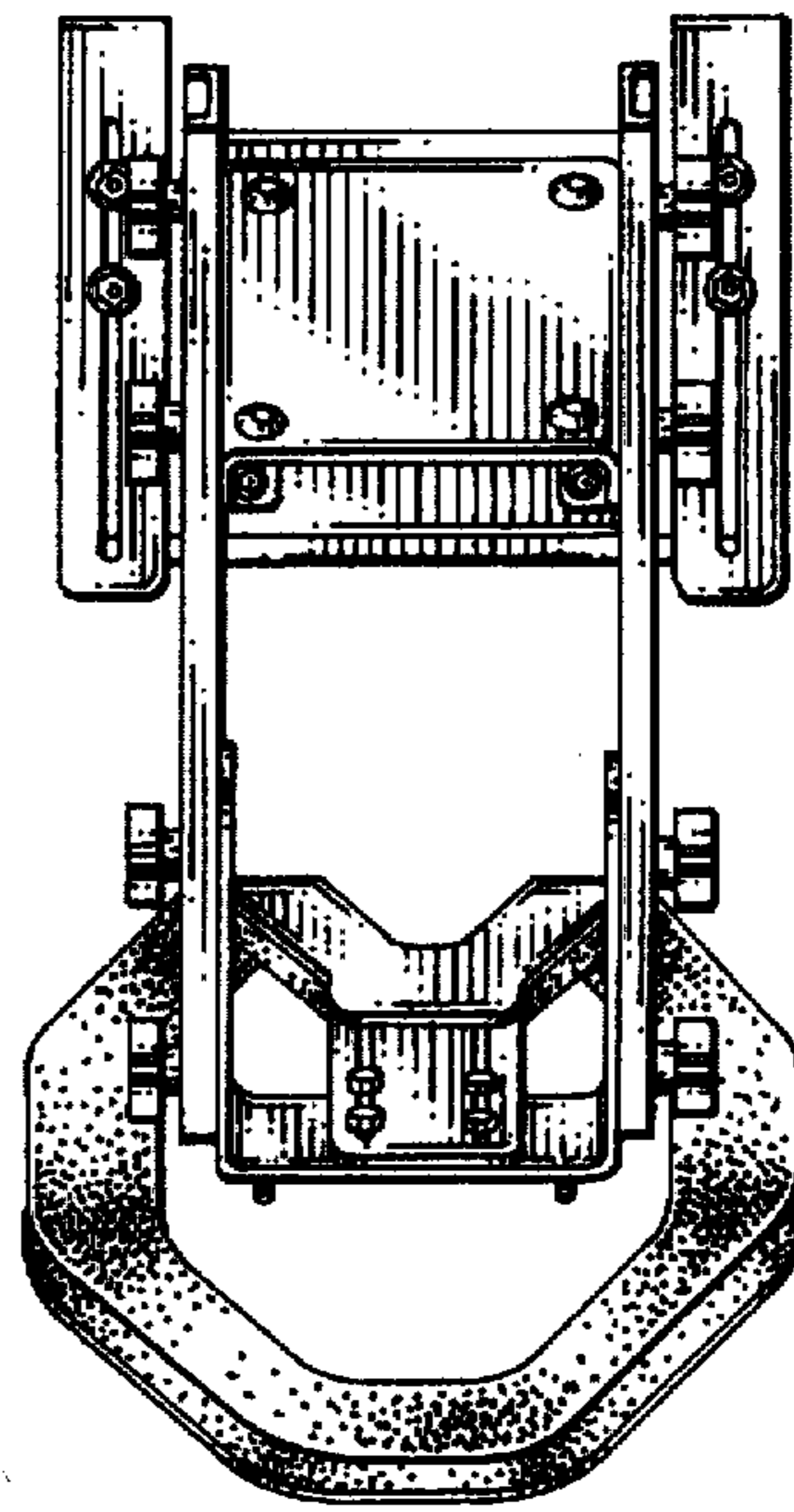

FIG. 12