



US00D388118S

United States Patent [19]

Sato

[11] Patent Number: Des. 388,118

[45] Date of Patent: **Dec. 23, 1997

[54] PAPER BINDER

[76] Inventor: Hisao Sato, Fujimidai Mansion 2002, 29-10, Nukui 1-chome, Nerima-ku, Tokyo, Japan

[**] Term: 14 Years

[21] Appl. No.: 52,189

[22] Filed: Mar. 26, 1996

[51] LOC (6) Cl. 19-04

[52] U.S. Cl. D19/27

[58] Field of Search D19/26, 27, 28, D19/29, 30, 31, 32, 33; 281/15.1, 21.1, 22, 29, 45; 402/60, 61, 64, 68, 70, 75, 77, 500, 62

[56] References Cited

U.S. PATENT DOCUMENTS

102,237	4/1870	Emerson	D19/274
D. 282,377	1/1986	Curran	D19/26
D. 319,649	9/1991	Silvanoinen	D19/26 X
3,201,145	8/1965	Libby	281/294
4,113,394	9/1978	Giulie	D19/264
4,375,296	3/1983	Chang	281/45
5,413,430	5/1995	Schram et al.	402/60
5,472,238	12/1995	Sato	

Primary Examiner—Susan J. Lucas
Assistant Examiner—Pamela Burgess
Attorney, Agent, or Firm—Kanesaka & Takeuchi

[57] CLAIM

The ornamental design for a paper binder, as shown and described.

DESCRIPTION

FIG. 1 is a perspective view of a paper binder showing my new design;
 FIG. 2 is a top plan view thereof;
 FIG. 3 is a front view thereof;
 FIG. 4 is a rear view thereof;
 FIG. 5 is a left side view thereof;
 FIG. 6 is a right side view thereof;
 FIG. 7 is a bottom plan view thereof;
 FIG. 8 is a magnified plan view showing a part taken along line 8—8 in FIG. 2;
 FIG. 9 is a cross sectional view taken along line 9—9 in FIG. 8;
 FIG. 10 is a cross sectional view taken along line 10—10 in FIG. 8;
 FIG. 11 is a perspective view of the paper binder in a state that the paper binder is closed;
 FIG. 12 is a perspective view of the paper binder in a state that a lever thereof is lifted up;
 FIG. 13 is a top plan view of another embodiment of the paper binder;
 FIG. 14 is a front view thereof;
 FIG. 15 is a rear view thereof;
 FIG. 16 is a left side view thereof;
 FIG. 17 is a right side view thereof;
 FIG. 18 is a perspective view of the paper binder shown in FIGS. 13-17 in a state that the paper binder is closed; and, FIG. 19 is a perspective view of the paper binder shown in FIGS. 13-18 in a state that a the paper binder is opened.

1 Claim, 12 Drawing Sheets

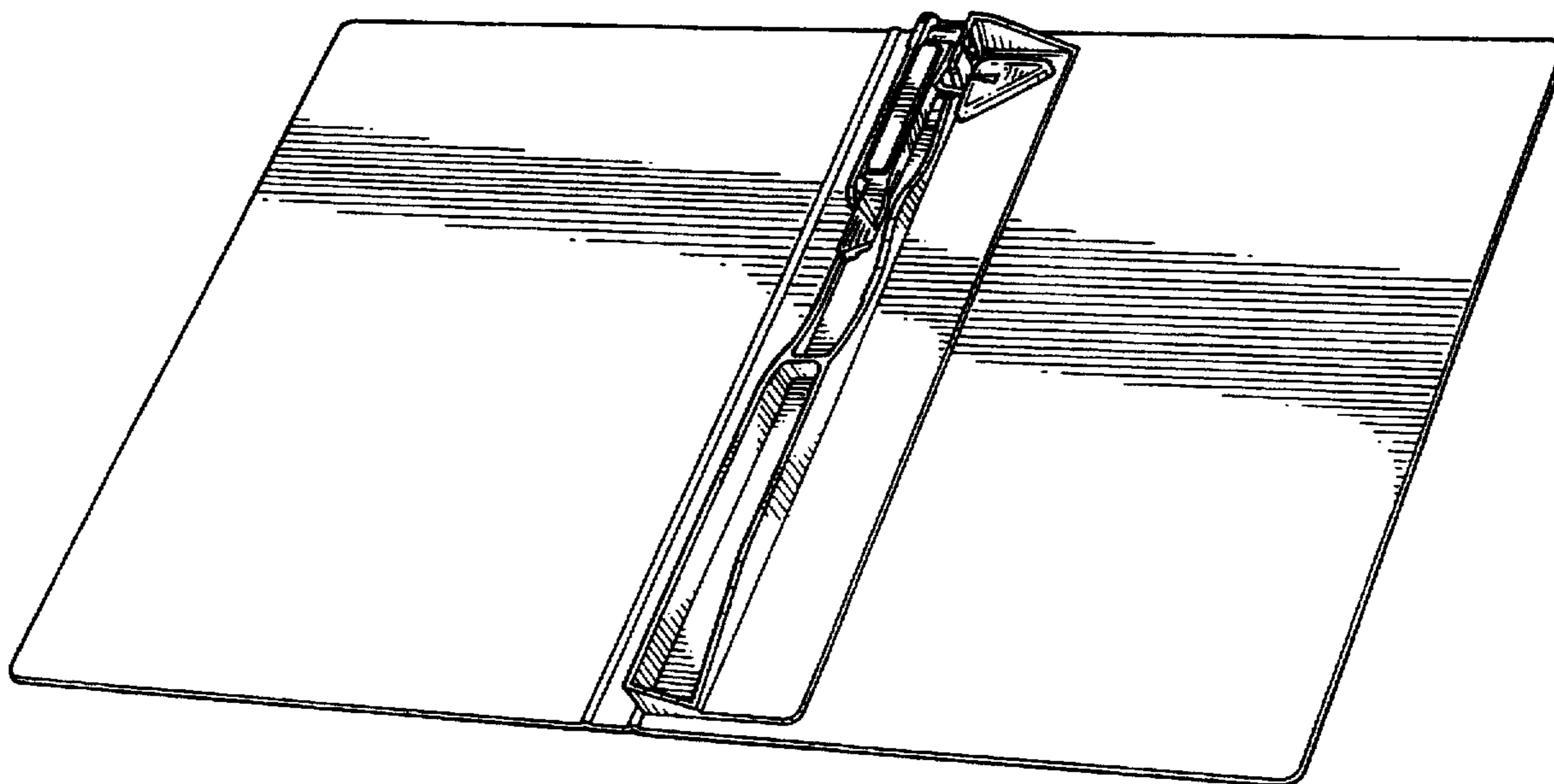

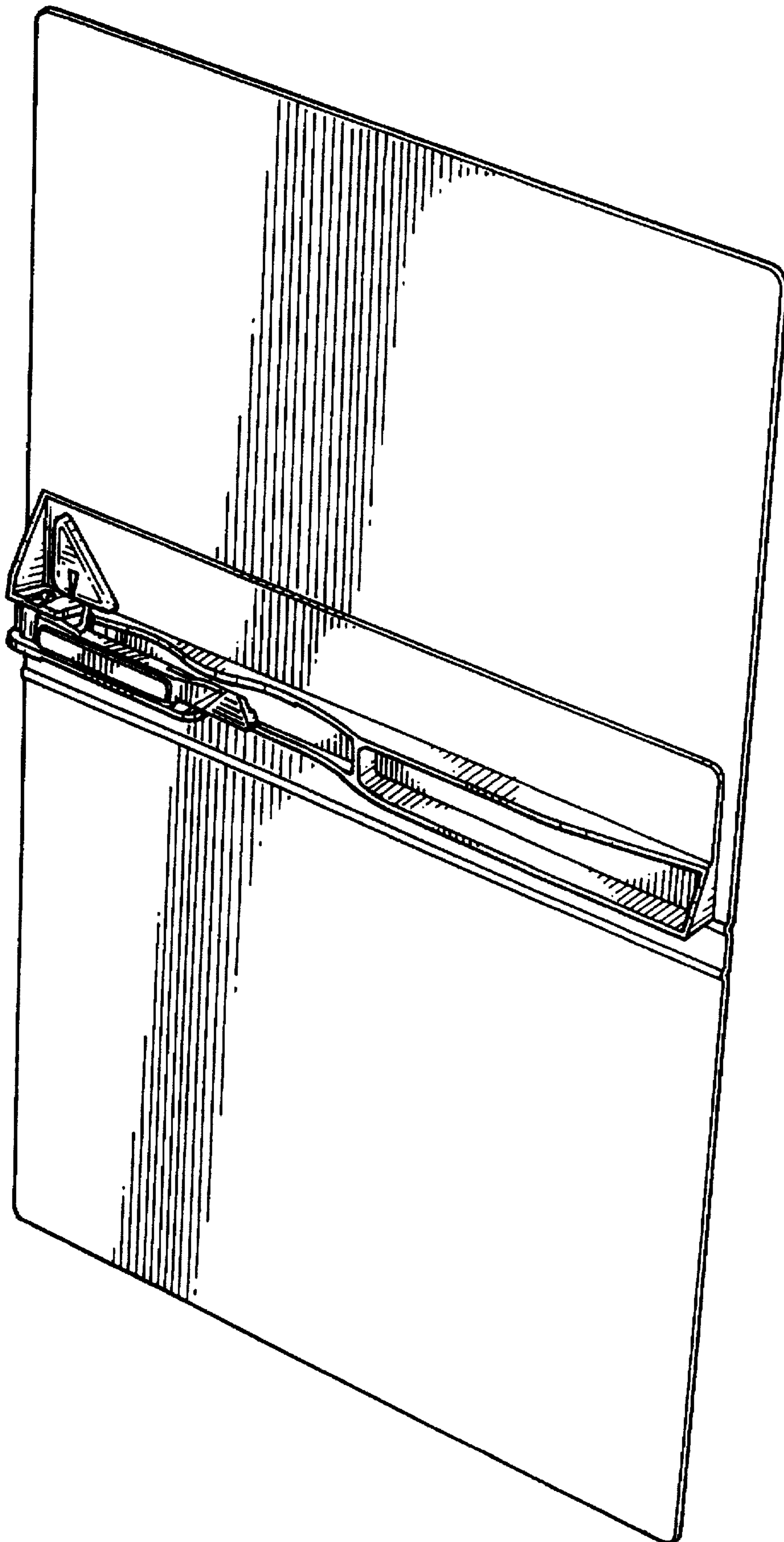

FIG. 1

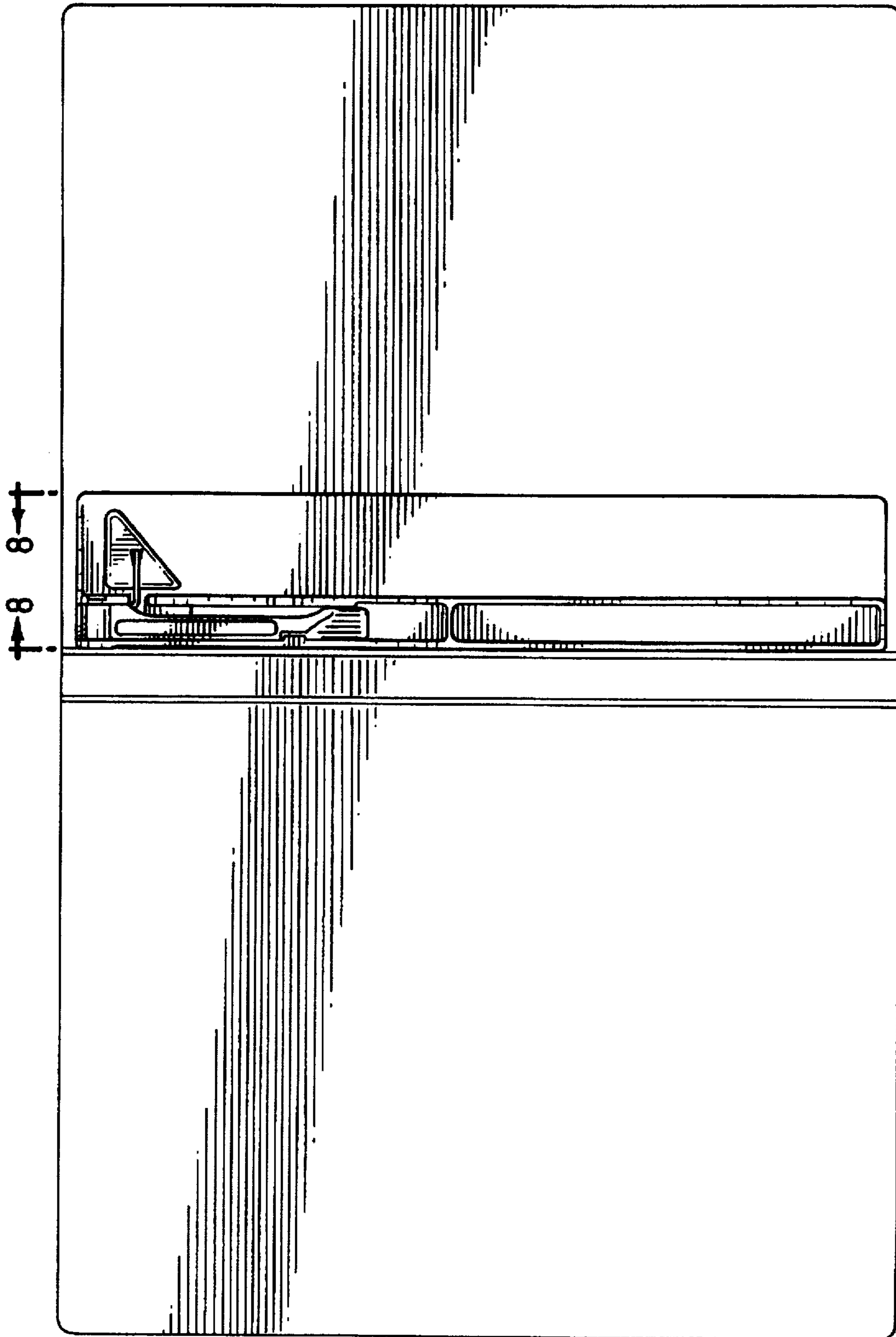

FIG. 2

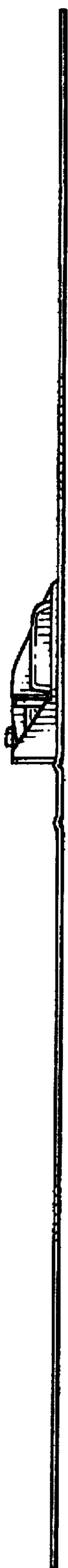

FIG. 3



FIG. 4



FIG. 5

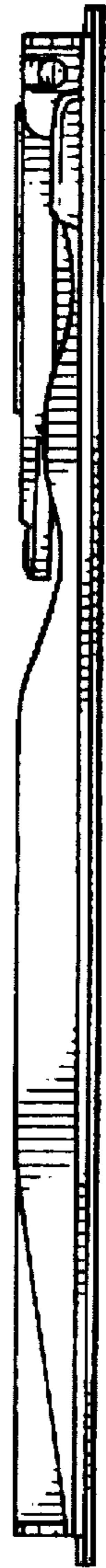

FIG. 6

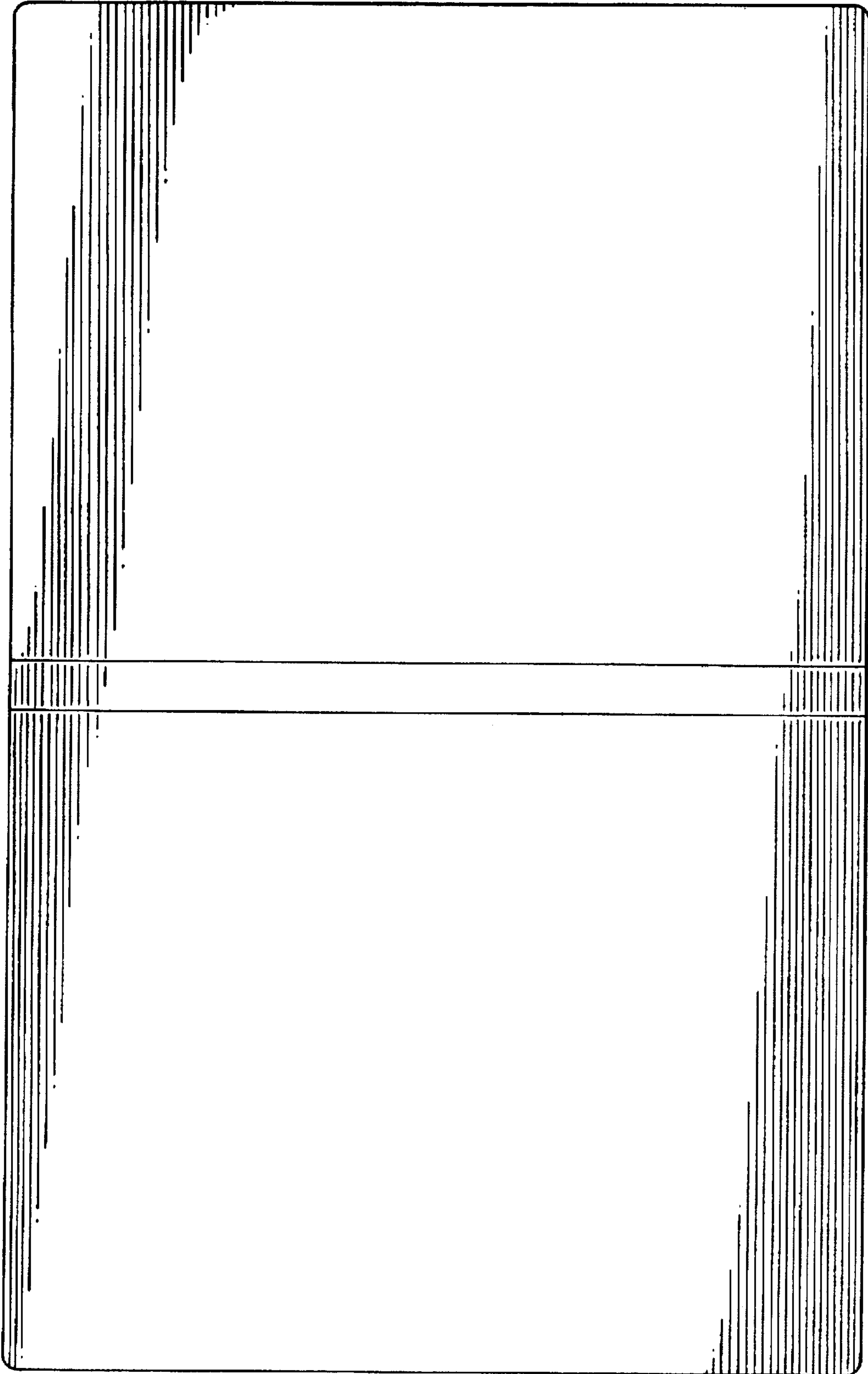

FIG. 7

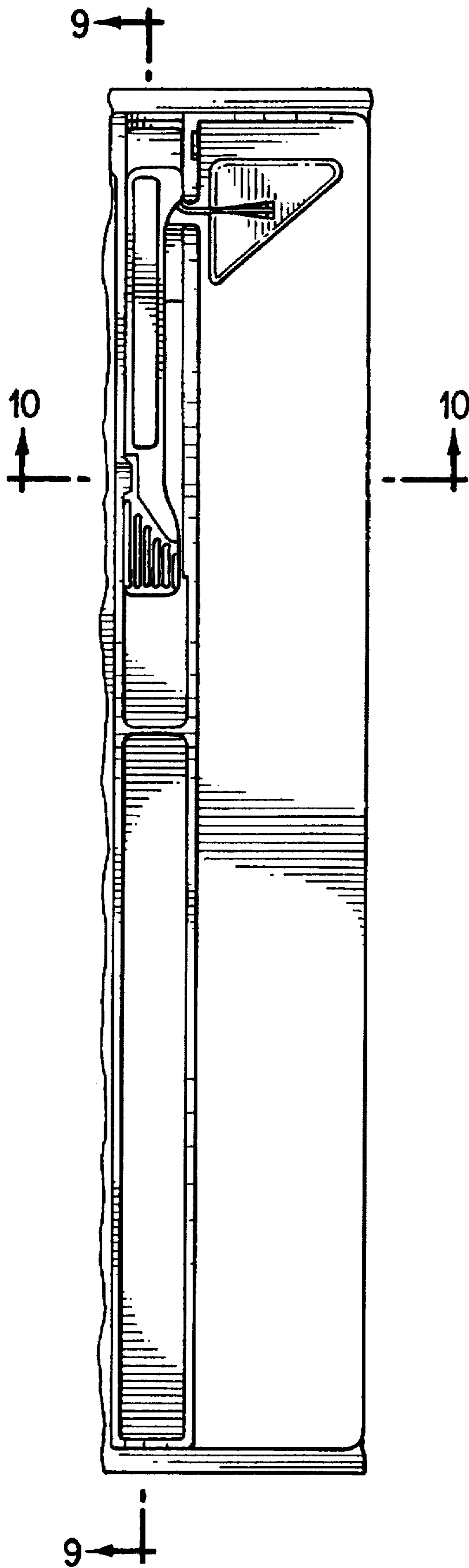

FIG. 8

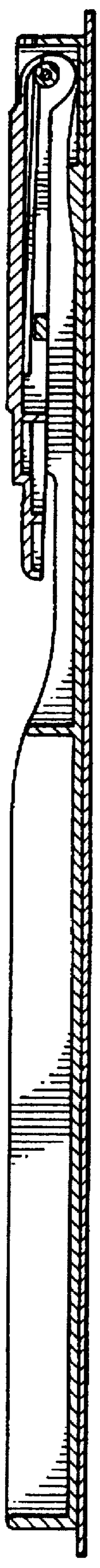

FIG. 9

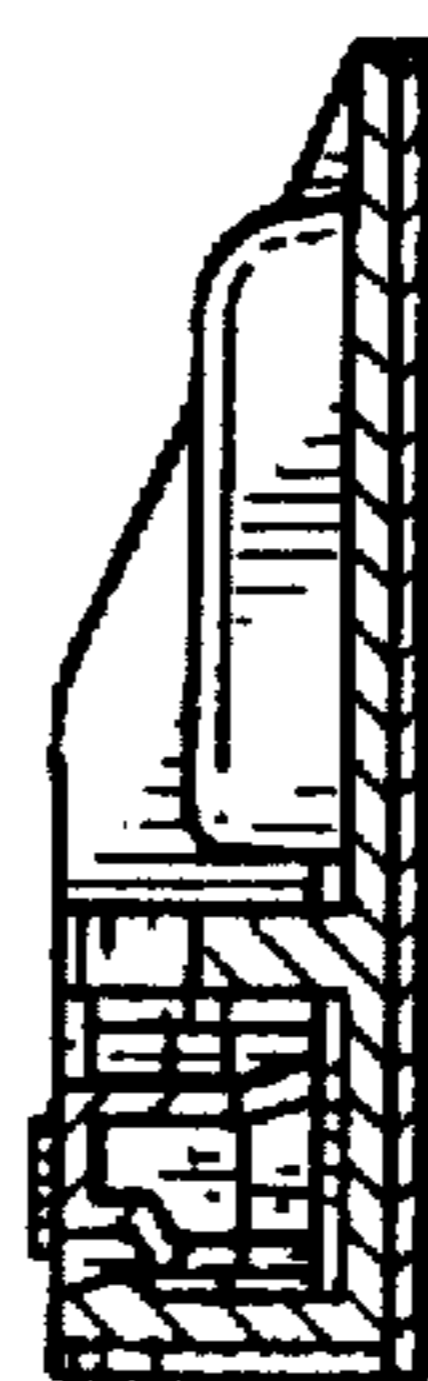

FIG. 10

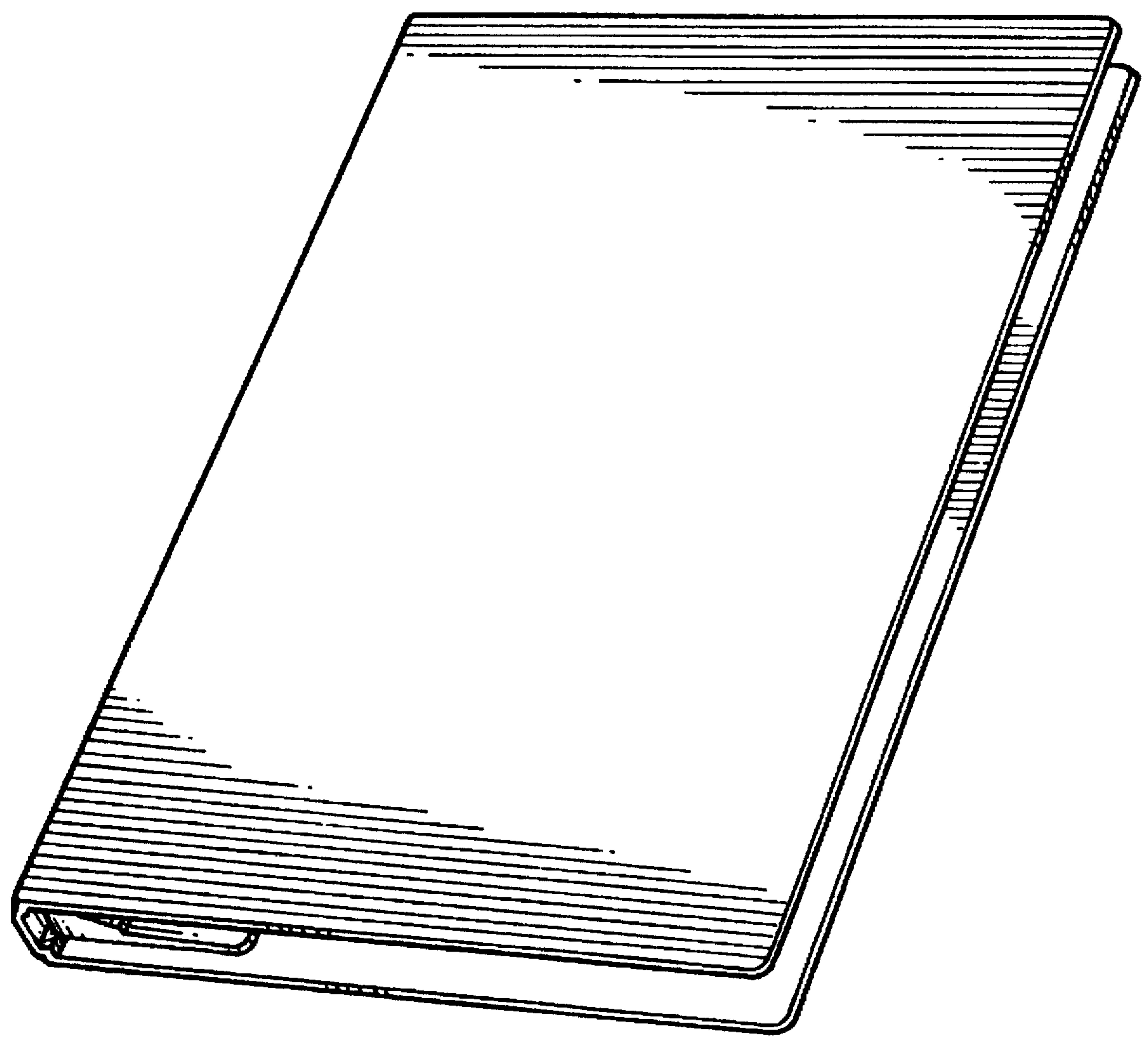

FIG. 11

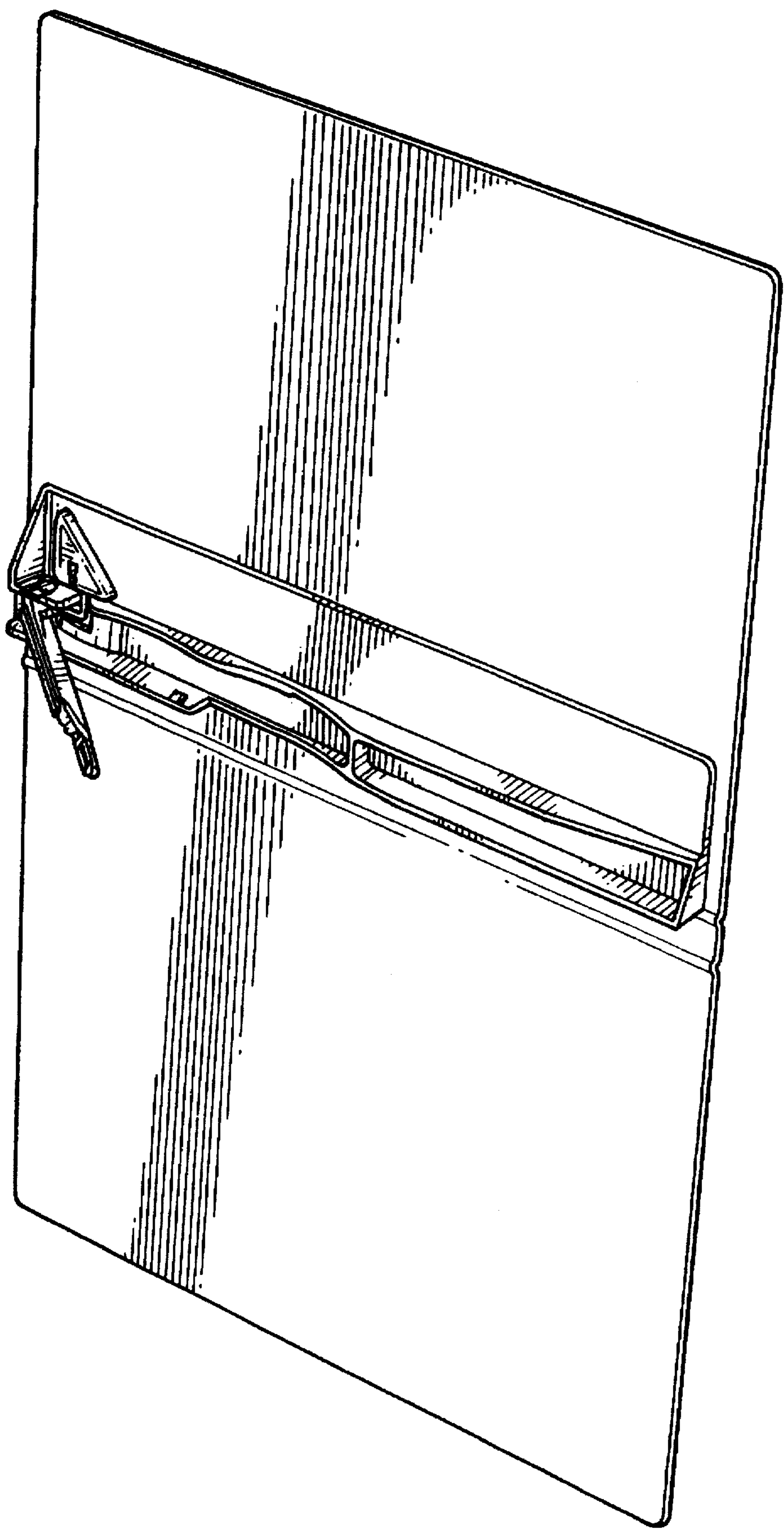

FIG. 12

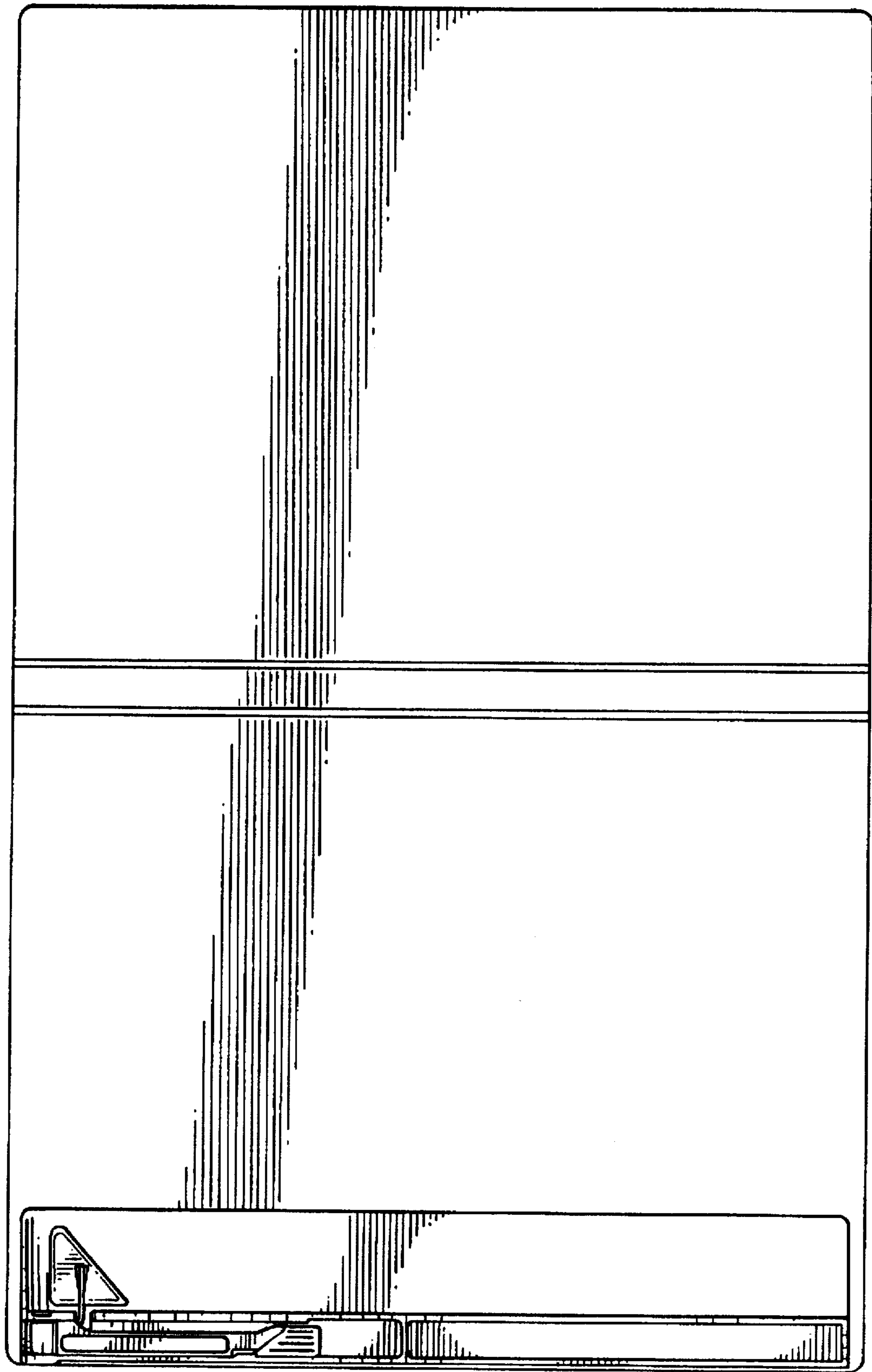

FIG. 13



FIG. 14



FIG. 15



FIG. 16



FIG. 17

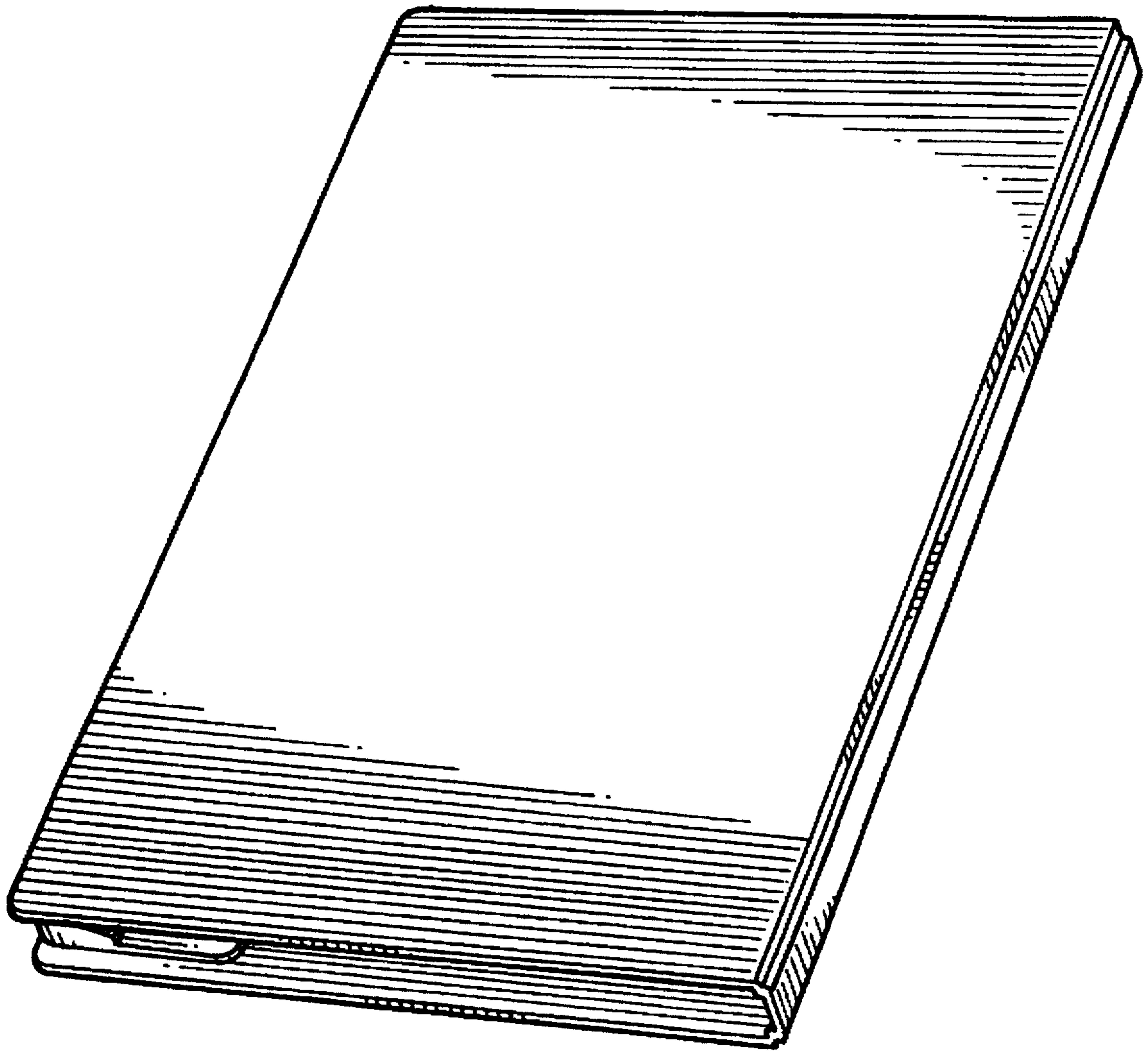

FIG. 18

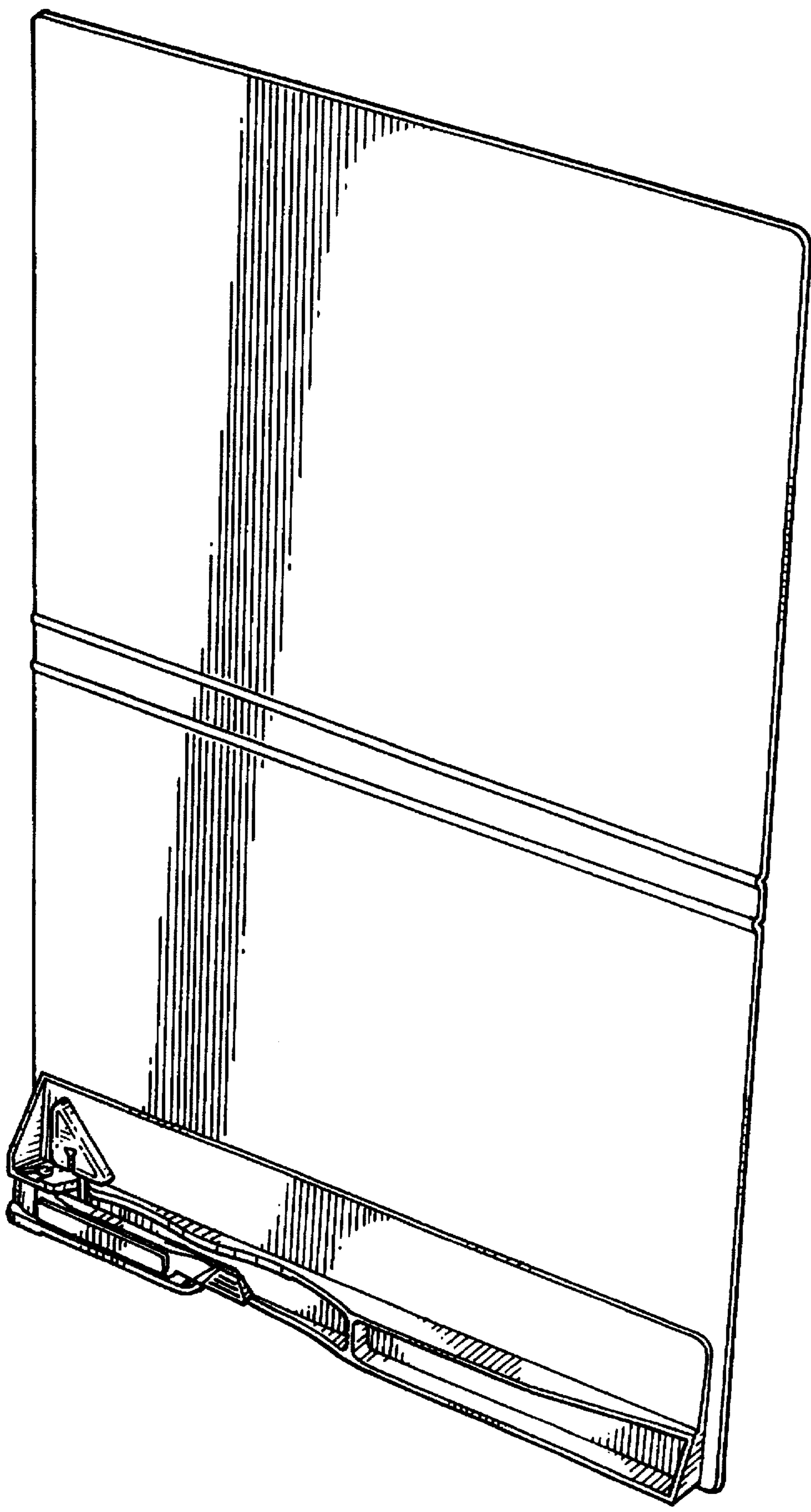

FIG. 19