



US00D388103S

United States Patent [19]
Gotou et al.

[11] **Patent Number:** **Des. 388,103**
[45] **Date of Patent:** ****Dec. 23, 1997**

[54] **ELECTRICAL DISCHARGE MACHINE**

5,175,408 12/1992 Takashima 219/69.14
5,410,119 4/1995 Lehmann 219/69.12
5,530,217 6/1996 Knecht 219/69.15 X
5,539,172 7/1996 Takase et al. 219/69.2

[75] **Inventors:** **Masato Gotou; Takanori Miyake;**
Makoto Tanaka, all of Tokyo, Japan

[73] **Assignee:** **Mitsubishi Denki Kabushiki Kaisha,**
Tokyo, Japan

Primary Examiner—Antoine Duval Davis
Attorney, Agent, or Firm—Oblon, Spivak, McClelland,
Maier & Neustadt, P.C.

[**] **Term:** **14 Years**

[57] **CLAIM**

[21] **Appl. No.:** **57,277**

The ornamental design for an electrical discharge machine,
as shown.

[22] **Filed:** **Jul. 22, 1996**

[30] **Foreign Application Priority Data**

DESCRIPTION

Jan. 22, 1996 [JP] Japan 8-1213

FIG. 1 is a front elevational view of an electrical discharge
machine, showing our new design;

[51] **LOC (6) Cl.** **15-09**

FIG. 2 is a rear elevational view thereof;

[52] **U.S. Cl.** **D15/127; D15/122**

FIG. 3 is a right side elevational view thereof;

[58] **Field of Search** **D15/122, 127,**

D15/135; 76/4; 219/69.12, 69.14, 69.15,
69.16, 69.17, 69.2; 252/570

FIG. 4 is a left side elevational view thereof;

FIG. 5 is a top plan view thereof;

FIG. 6 is a bottom plan view thereof;

FIG. 7 is a front, top and right side perspective view thereof;

FIG. 8 is a front, top and left side perspective view thereof;

and,

FIG. 9 is a front elevational reference view thereof with the
light-transmitting portion thereof tinted.

[56] **References Cited**

U.S. PATENT DOCUMENTS

D. 277,679 2/1985 Kitamura D15/127
D. 286,407 10/1986 Itoh et al. D15/127
D. 302,165 7/1989 Itoh et al. D15/127

1 Claim, 9 Drawing Sheets

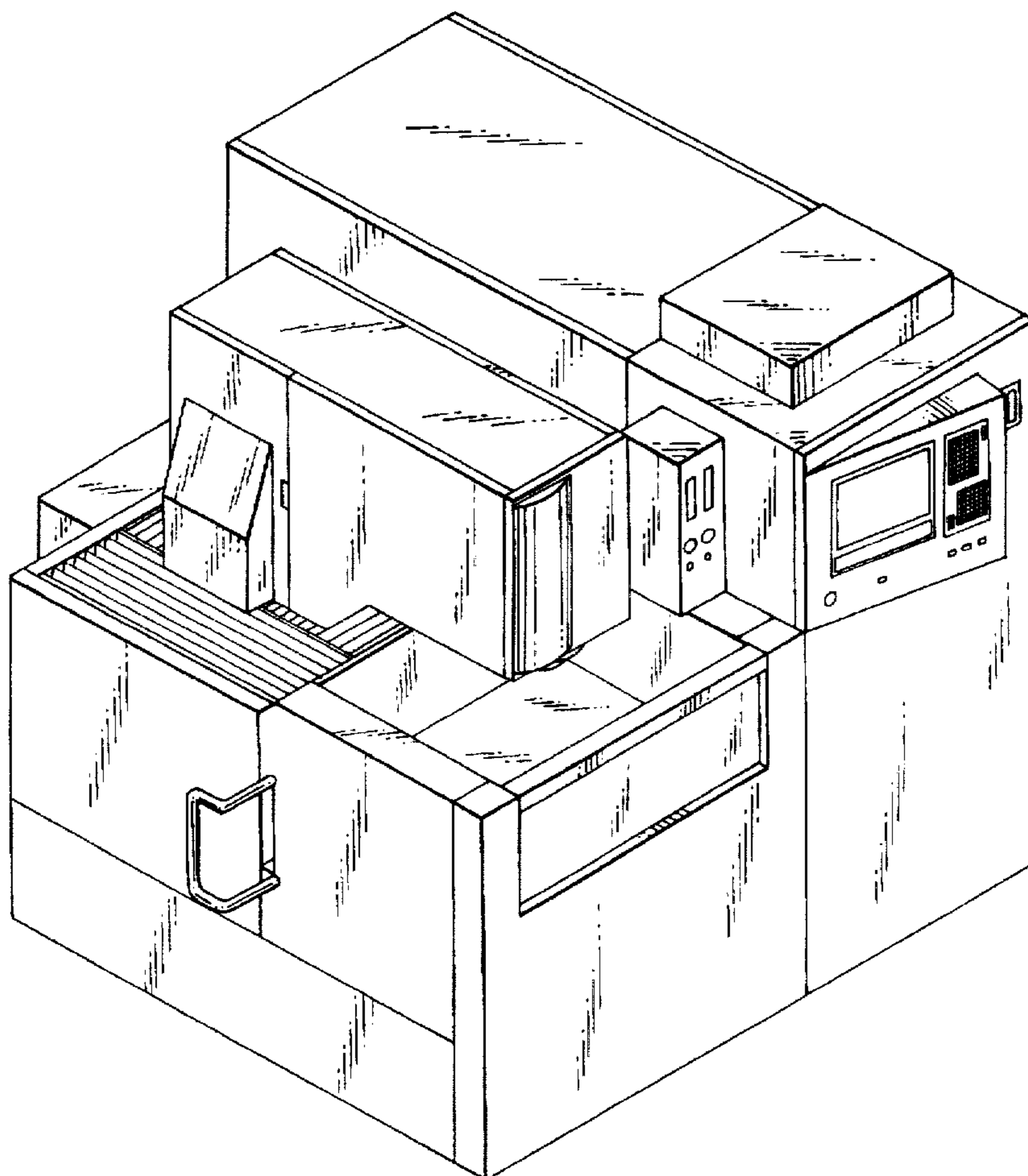

FIG. 1

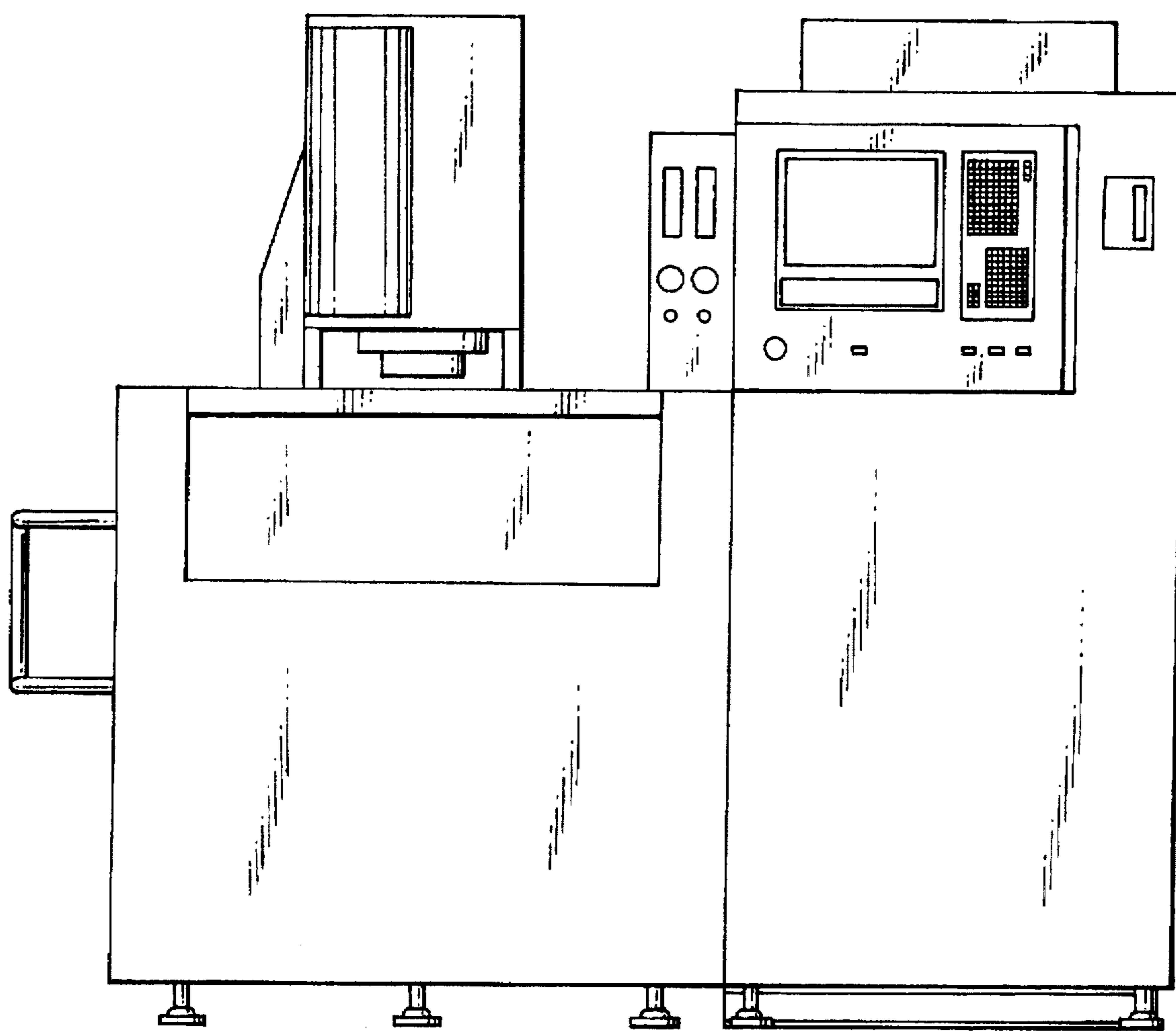

FIG. 2

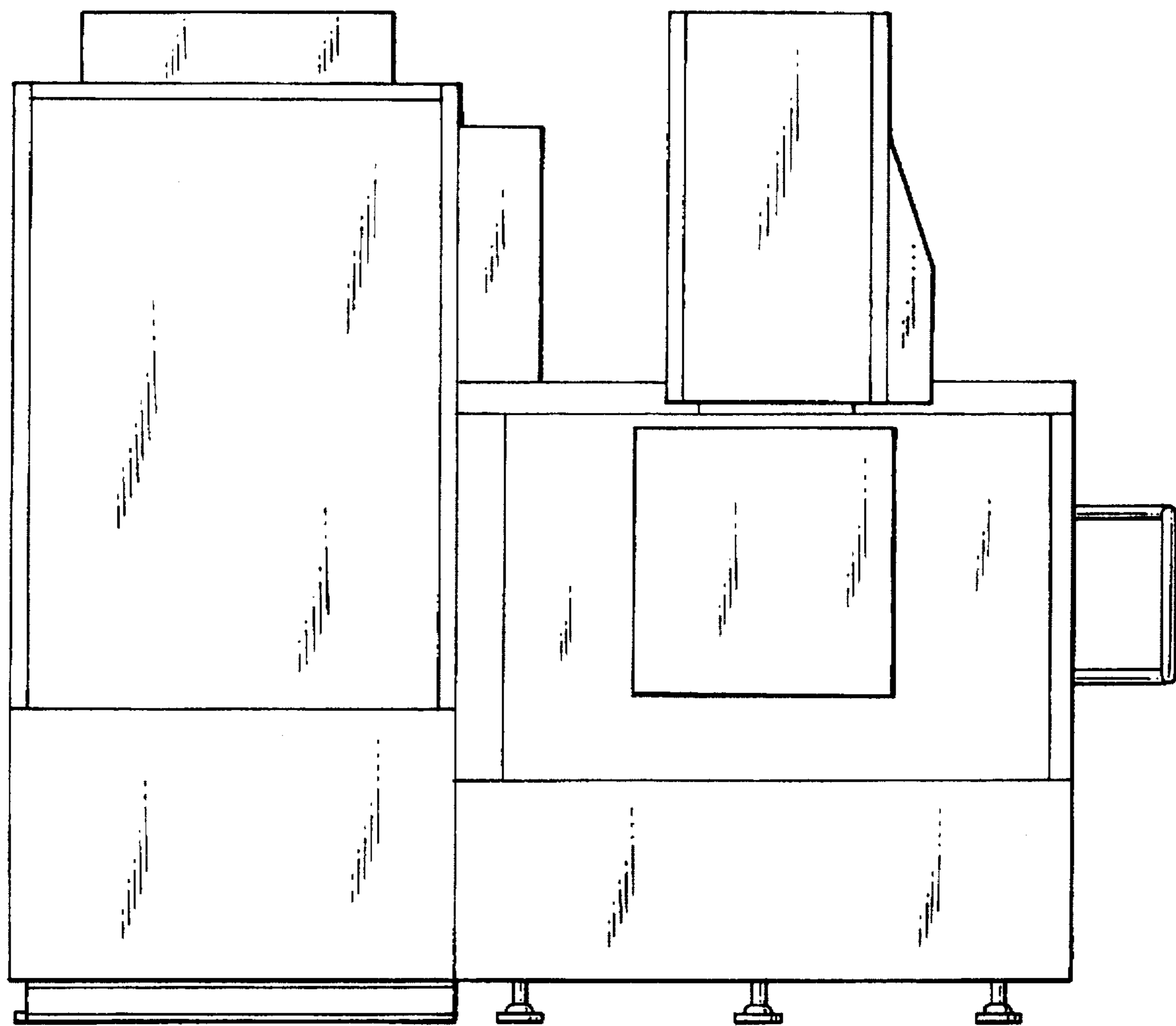

FIG. 3

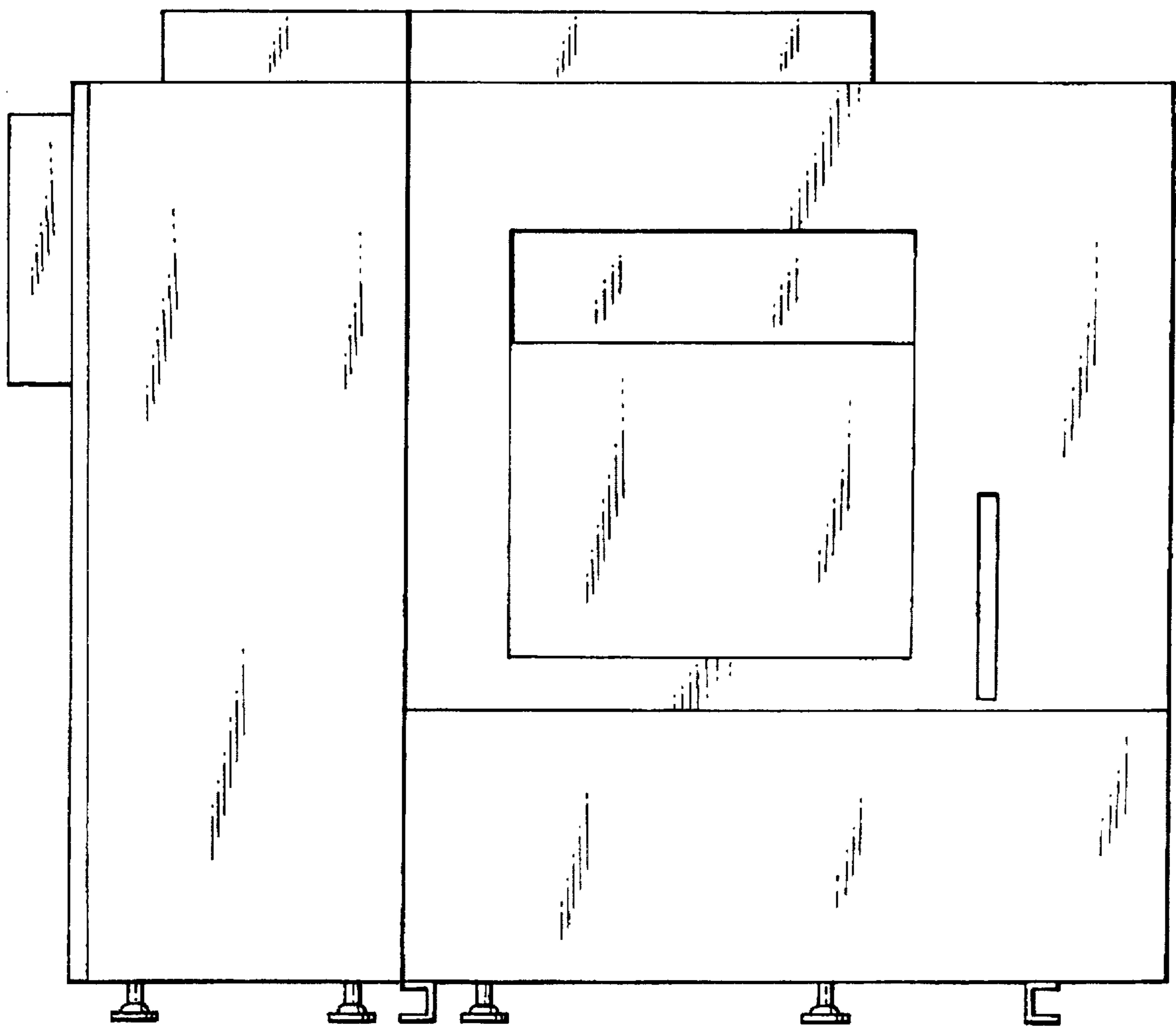

FIG. 4

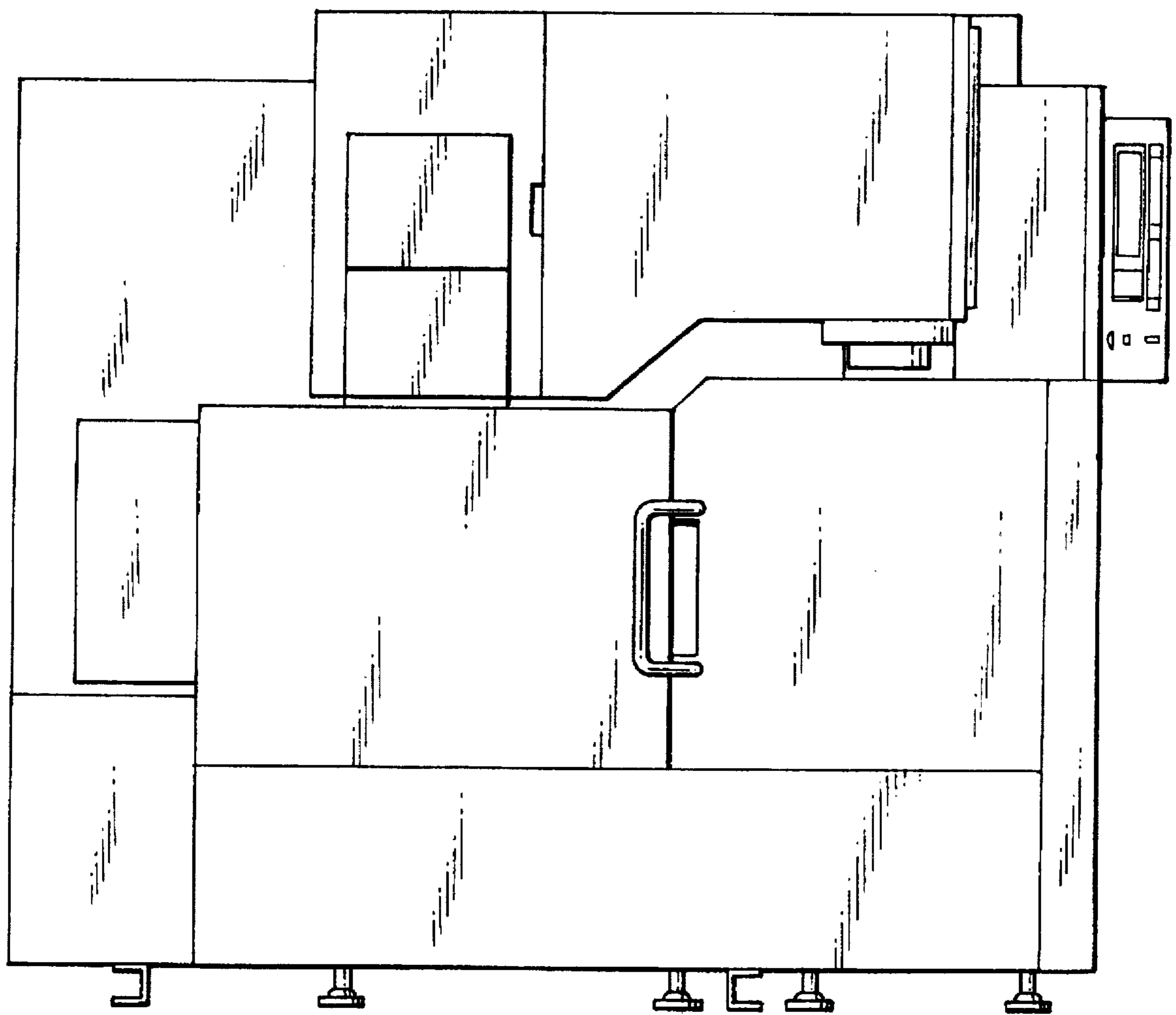

FIG. 5

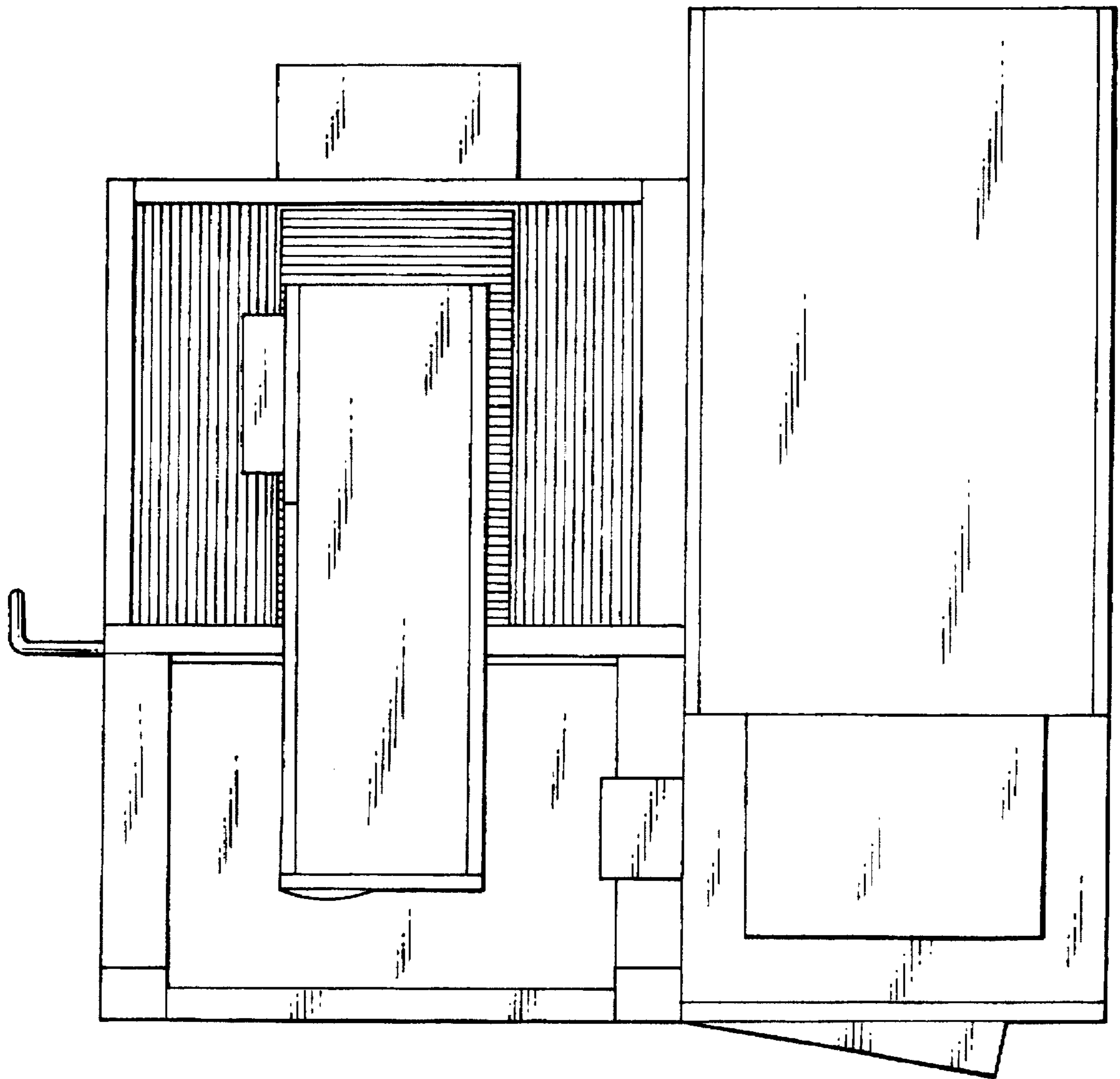

FIG. 6

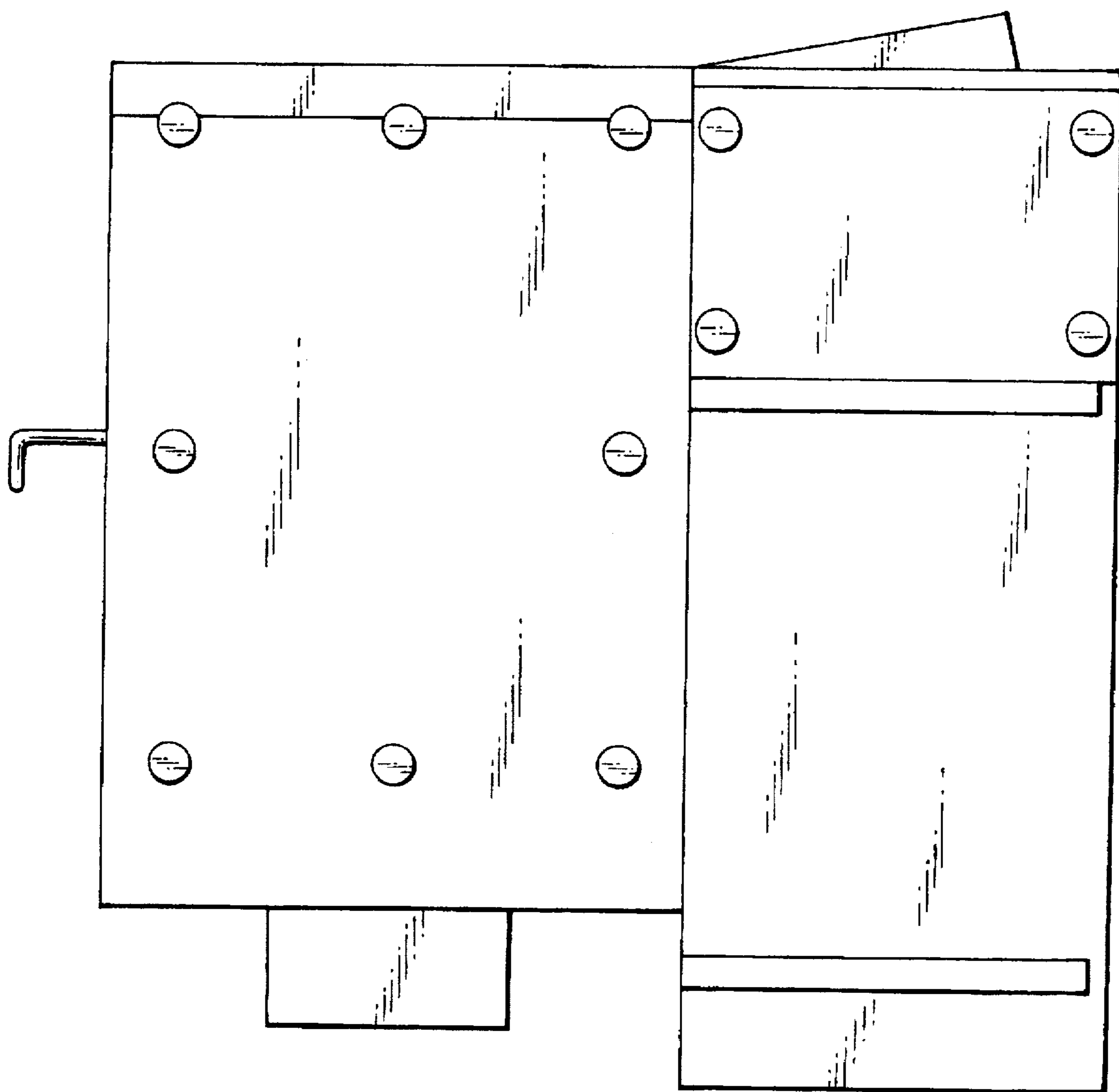

FIG. 7

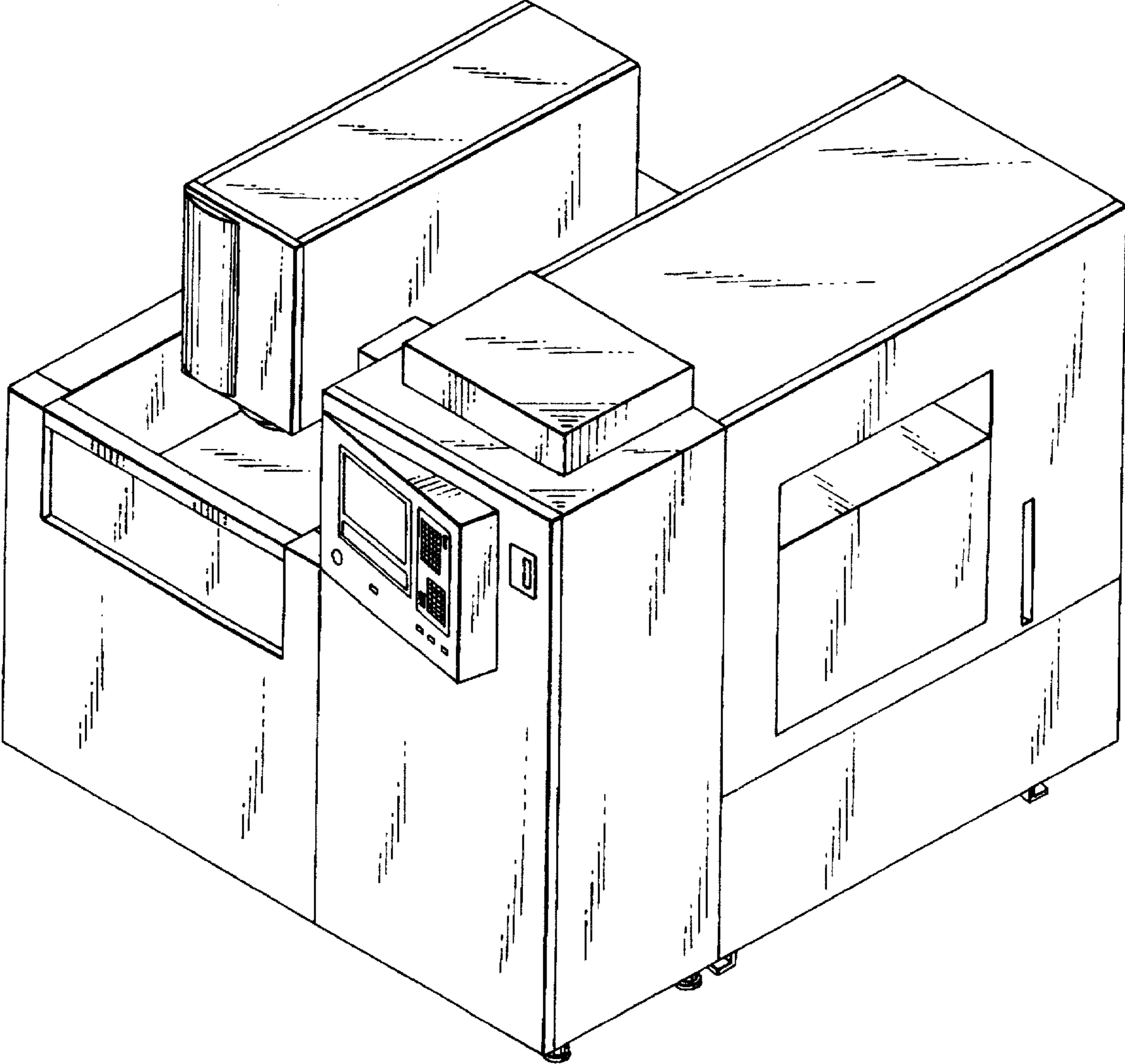

FIG. 8

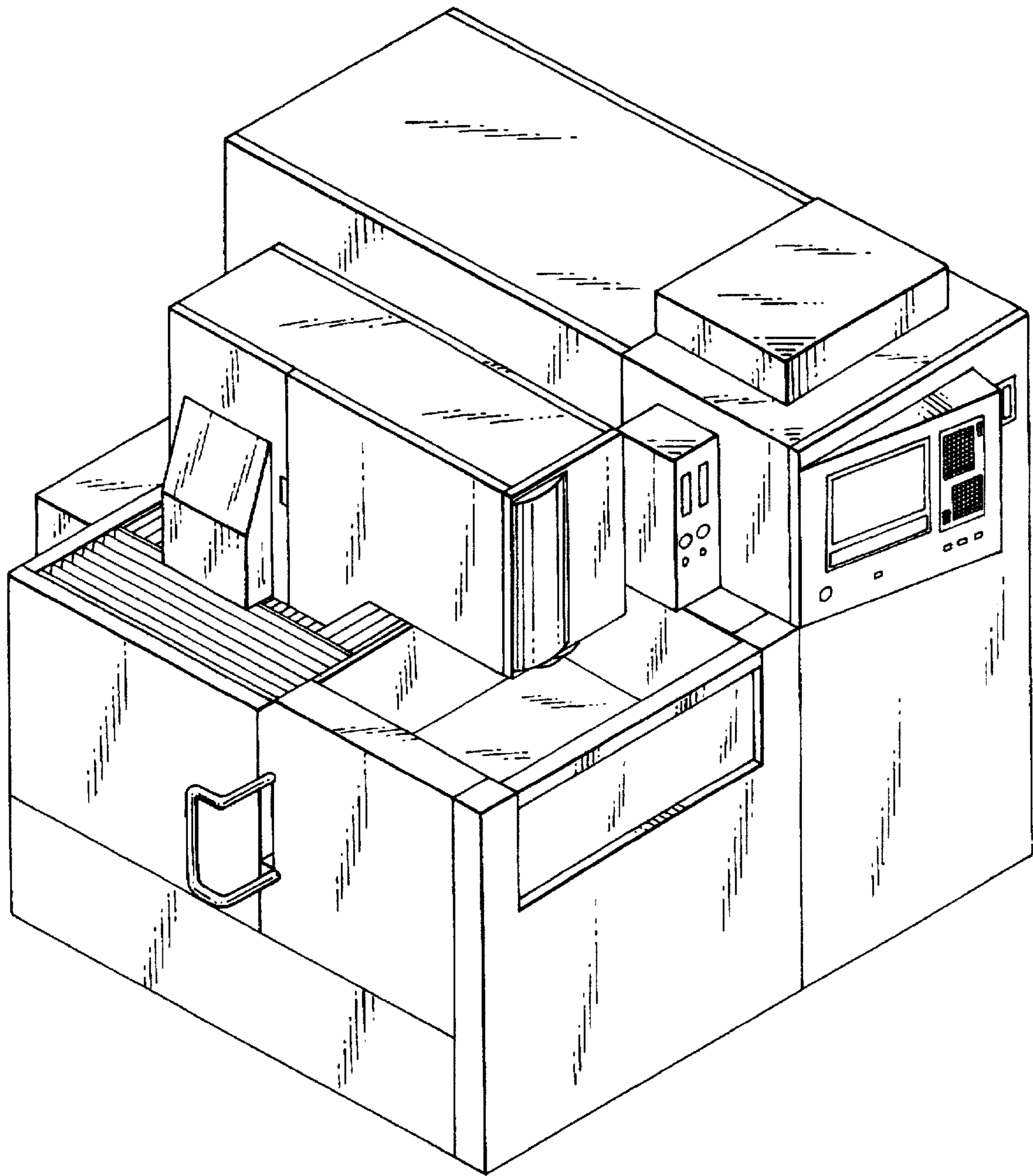

FIG. 9

