

US00D388094S

**United States Patent** [19]  
**Tokiyama et al.**

[11] **Patent Number:** **Des. 388,094**  
[45] **Date of Patent:** **\*\*Dec. 23, 1997**

[54] **COMBINED SPEAKER AND MICROPHONE**

[75] **Inventors:** **Masaru Tokiyama**, Coral Springs;  
**David Isaac Blatt**, Margate, both of Fla.; **Jeff Robert Beasley**, Buford, Ga.;  
**Michael Scott Henning**, Round Lake Beach, Ill.

[73] **Assignee:** **Motorola, Inc.**, Schaumburg, Ill.

[\*\*] **Term:** **14 Years**

[21] **Appl. No.:** **49,925**

[22] **Filed:** **Feb. 5, 1996**

[51] **LOC (6) Cl.** ..... **14-01**

[52] **U.S. Cl.** ..... **D14/226; D14/204**

[58] **Field of Search** ..... **D14/137, 138,**  
**D14/204, 225-229, 299; 181/158, 242;**  
**381/91, 122, 155, 159, 168-170**

[56] **References Cited**

**U.S. PATENT DOCUMENTS**

D. 294,257	2/1988	Nagele et al.	.....	D14/137
D. 295,404	4/1988	Tokiyama	.....	D14/226 X
D. 302,161	7/1989	Siddoway et al.	.....	D14/137 X
D. 336,300	6/1993	Tokiyama et al.	.....	D14/225
D. 346,804	5/1994	Tokiyama	.....	D14/226
D. 360,208	7/1995	Richards	.....	D14/204
2,699,473	1/1955	Kettler et al.	.....	181/158 X
5,086,509	2/1992	Inubushi et al.	.....	D14/138 X

*Primary Examiner*—Sandra L. Morris  
*Assistant Examiner*—Nanda A. Bondade  
*Attorney, Agent, or Firm*—Andrew S. Fuller

[57] **CLAIM**

The ornamental design for a combined speaker and microphone, as shown and described.

**DESCRIPTION**

FIG. 1 is a left side elevational view of a first embodiment of a combined speaker and microphone showing our new design;

FIG. 2 is a front elevational view thereof; and

FIG. 3 is a right side elevational thereof;

FIG. 4 is a rear elevational view thereof;

FIG. 5 is a top plan view thereof;

FIG. 6 is a bottom plan view thereof;

FIG. 7 is a bottom, front, and left side isometric view thereof;

FIG. 8 is a left side elevational view of a second embodiment of FIG. 1;

FIG. 9 is a front elevational view thereof; and

FIG. 10 is a right side elevational thereof;

FIG. 11 is a rear elevational view thereof;

FIG. 12 is a top plan view thereof;

FIG. 13 is a bottom plan view thereof; and,

FIG. 14 is a bottom, front, and left side isometric view thereof.

The broken lines shown in the FIGURES. are included for the purpose of illustrating environmental elements only, and form no part of the claimed design.

**1 Claim, 8 Drawing Sheets**

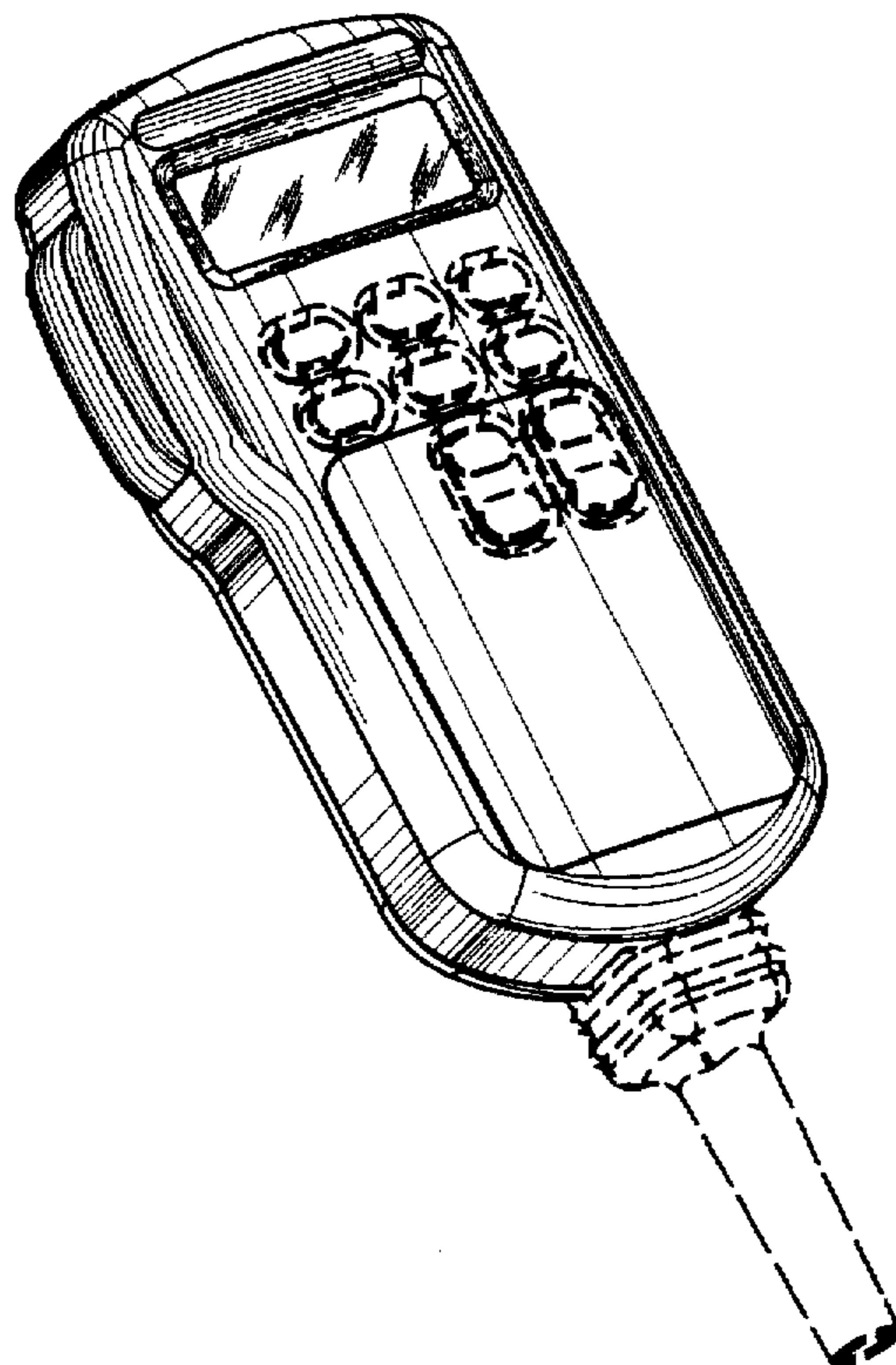
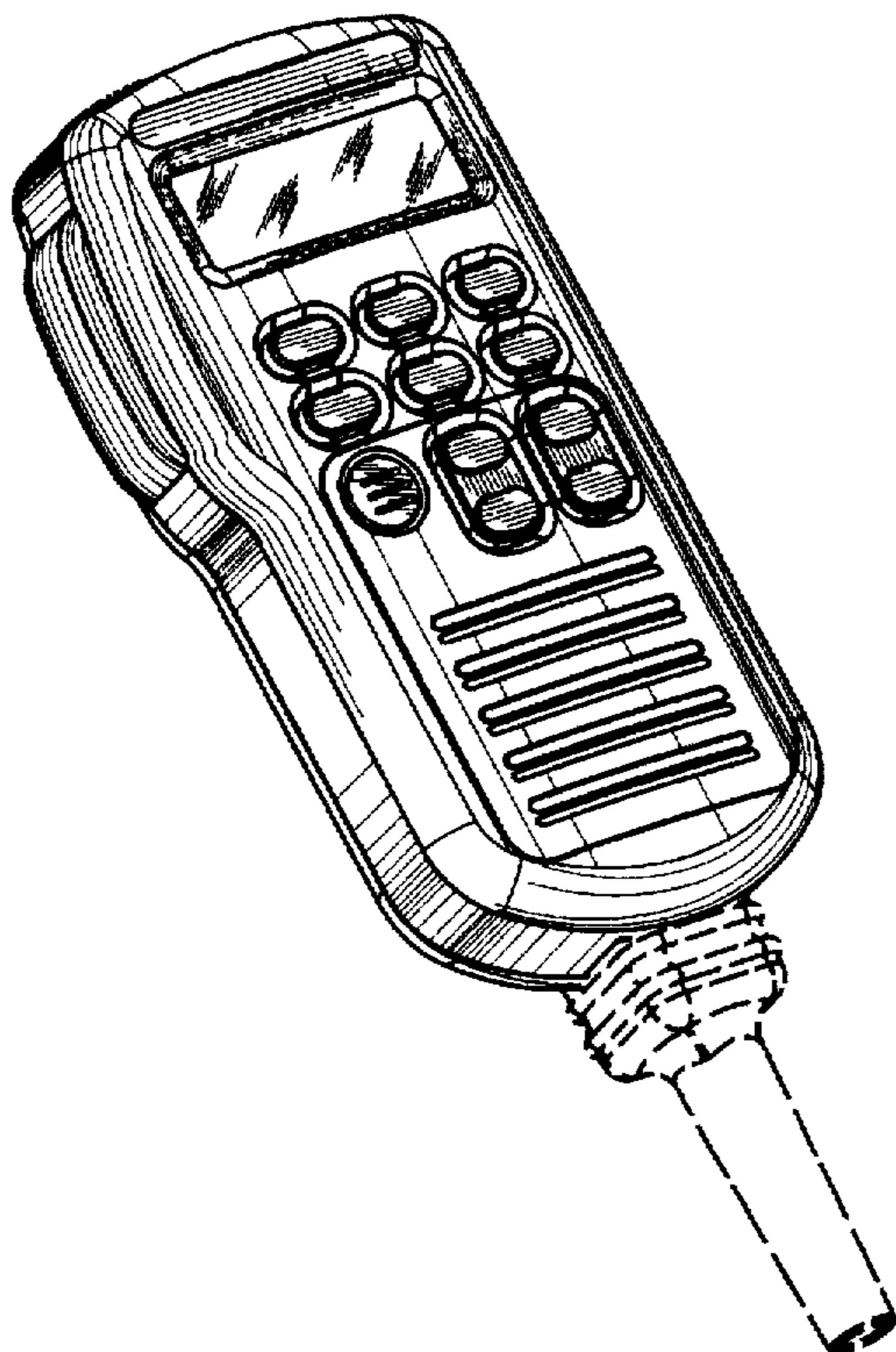

*FIG. 2*

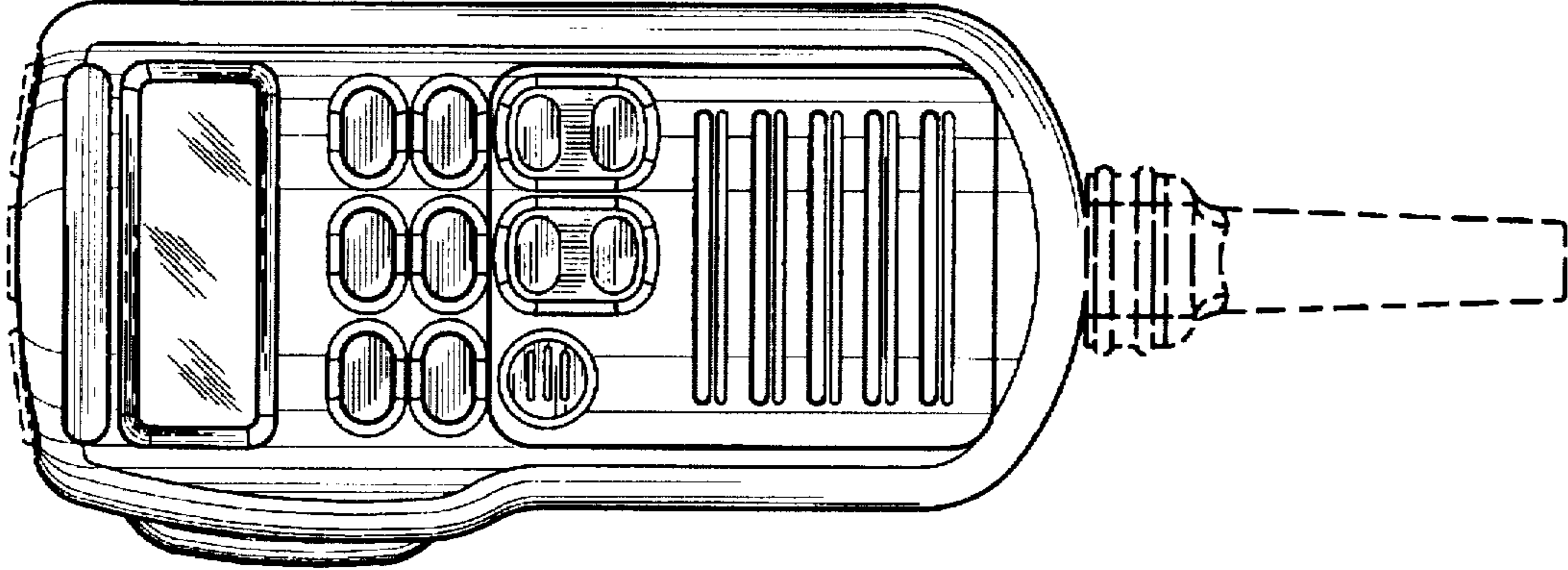

*FIG. 1*

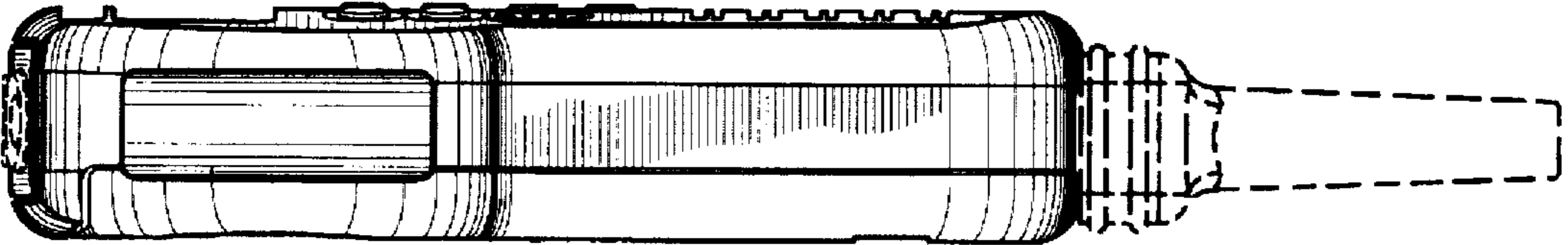

*FIG. 4*

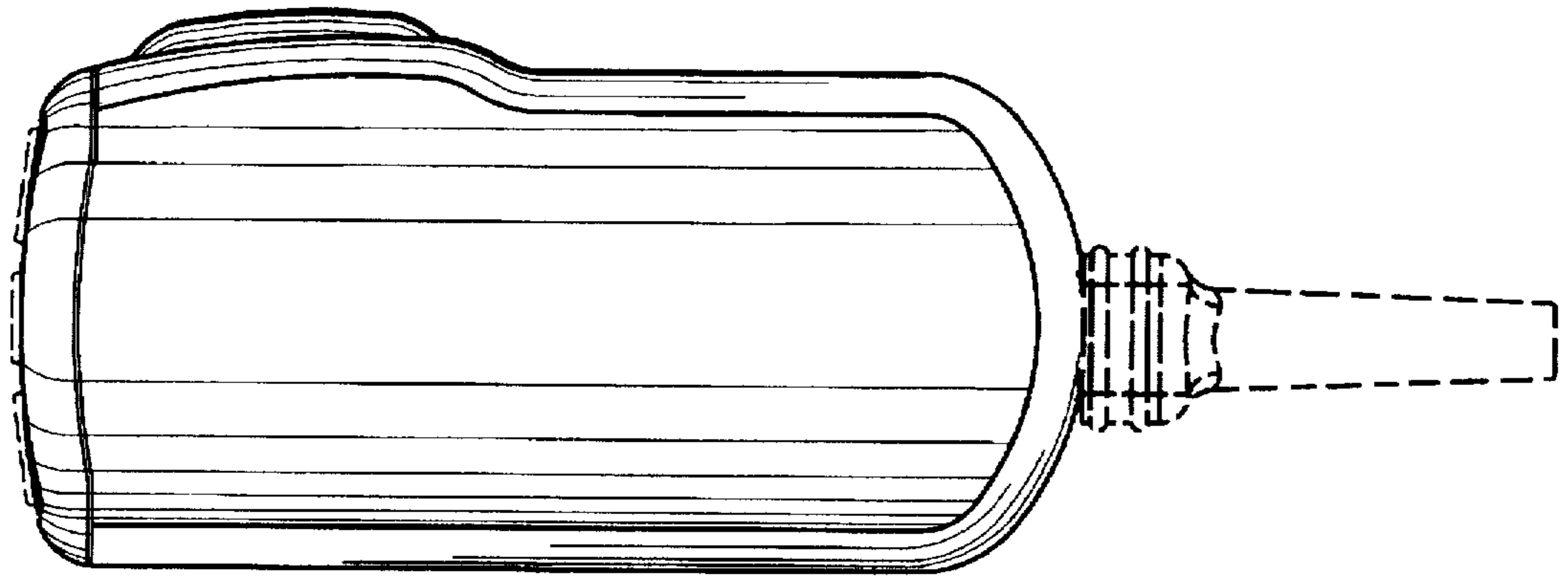

*FIG. 3*

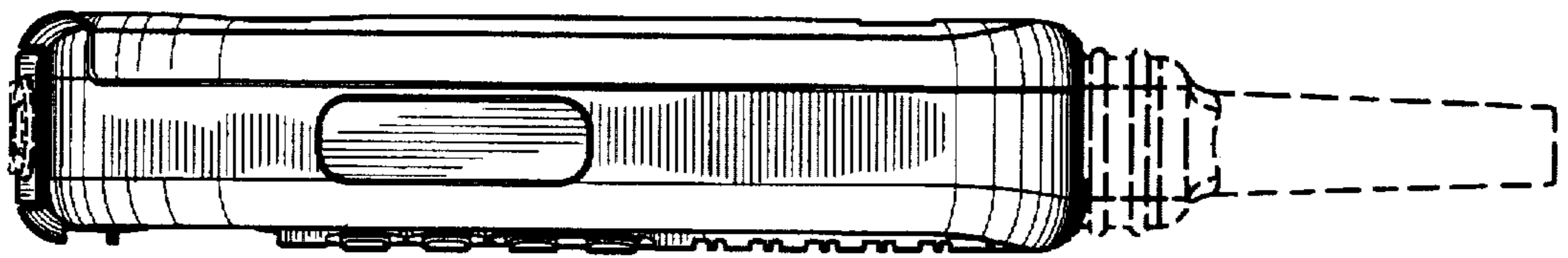

*FIG. 6*

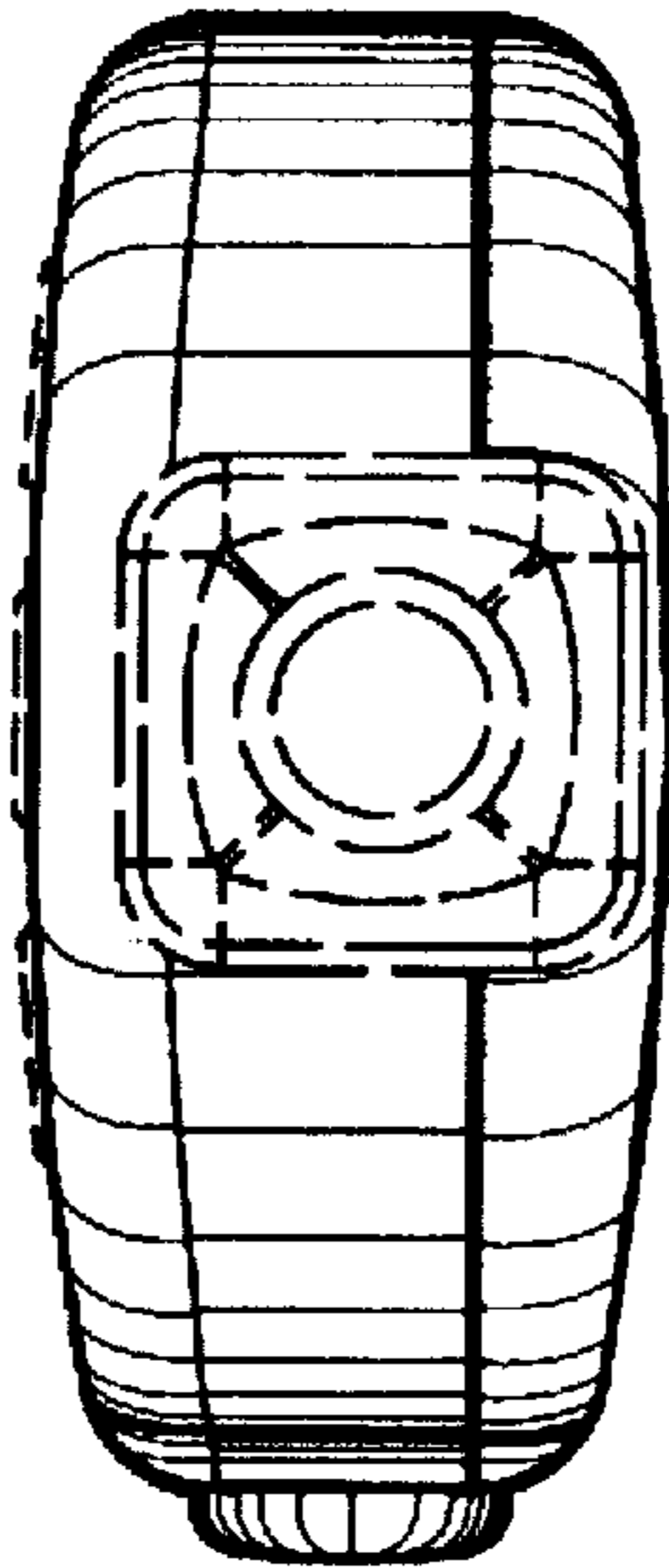

*FIG. 5*

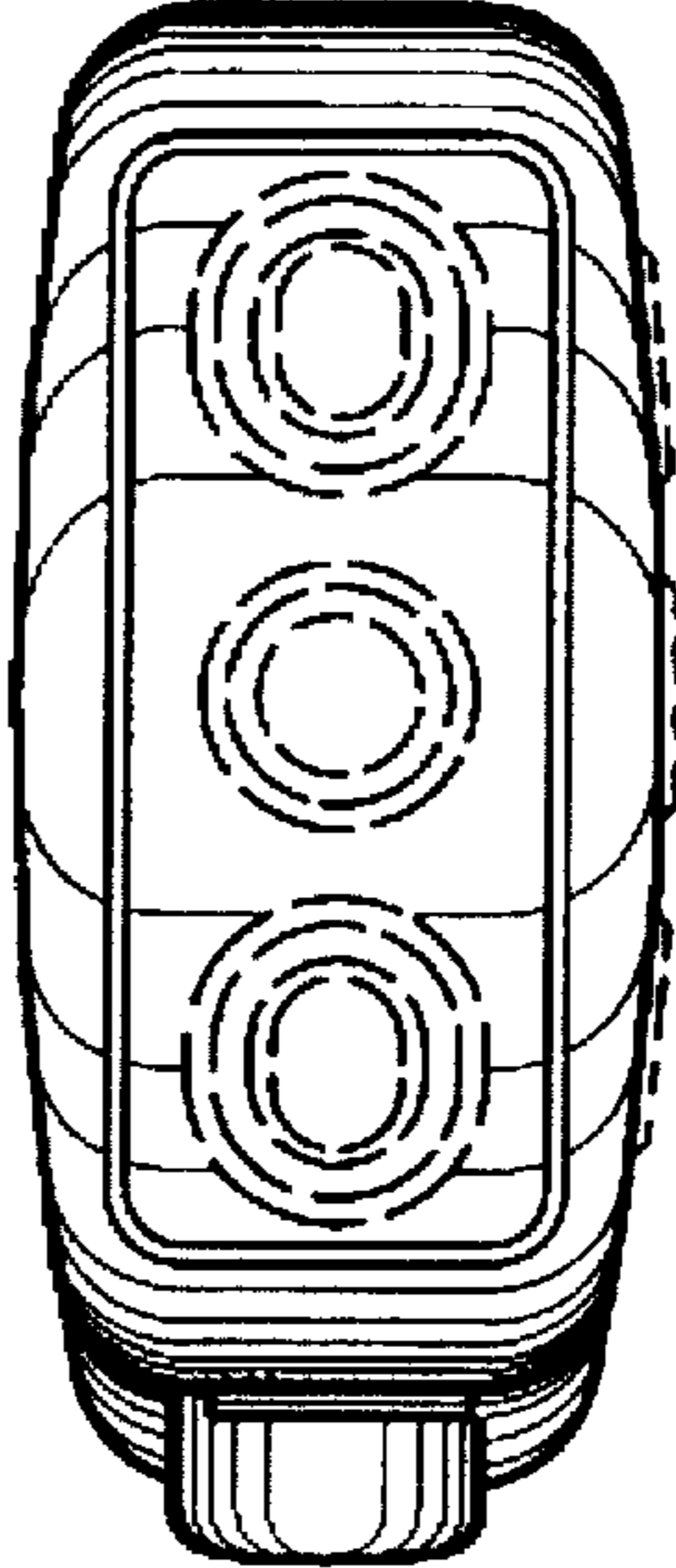

*FIG. 7*

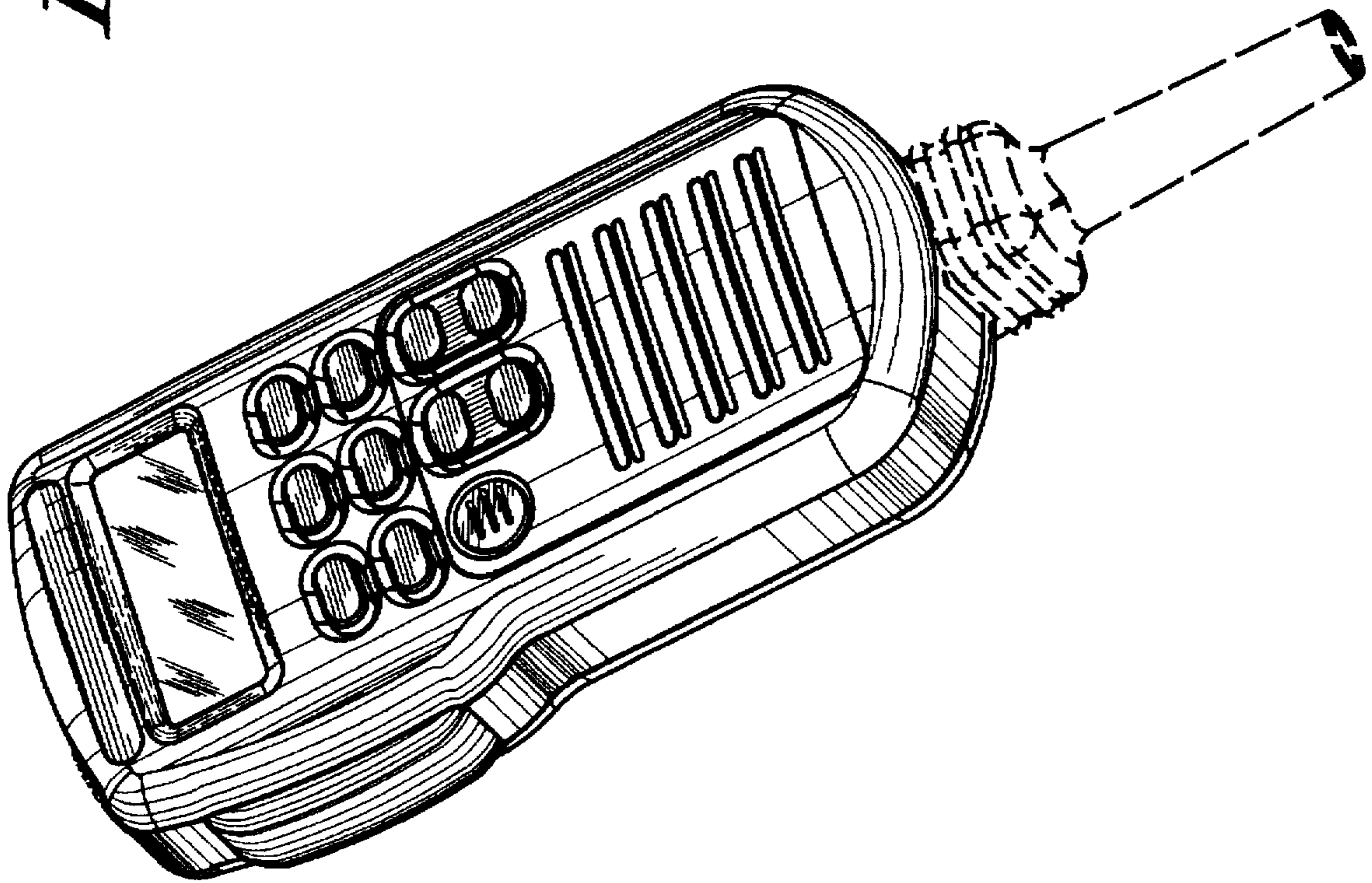

*FIG. 9*

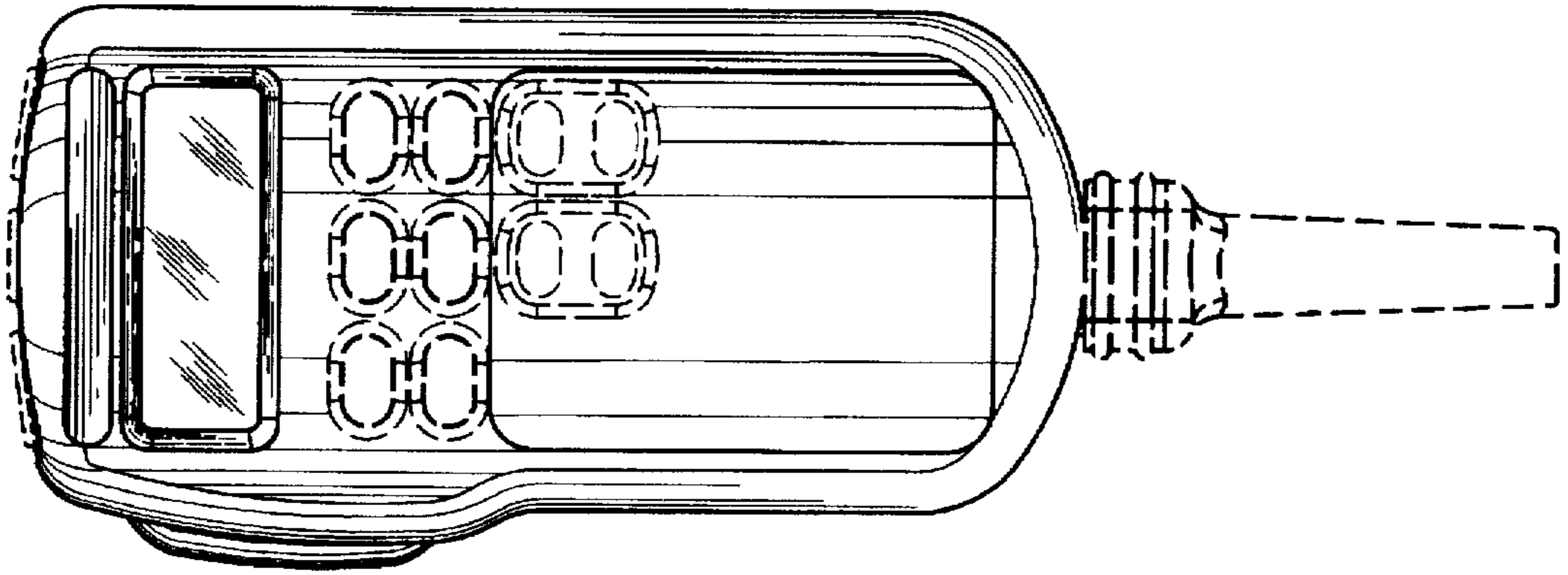

*FIG. 8*

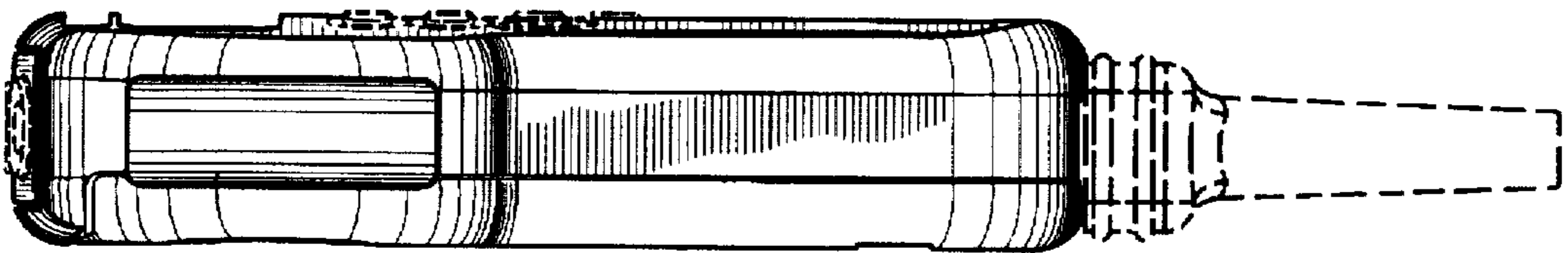

*FIG. 11*

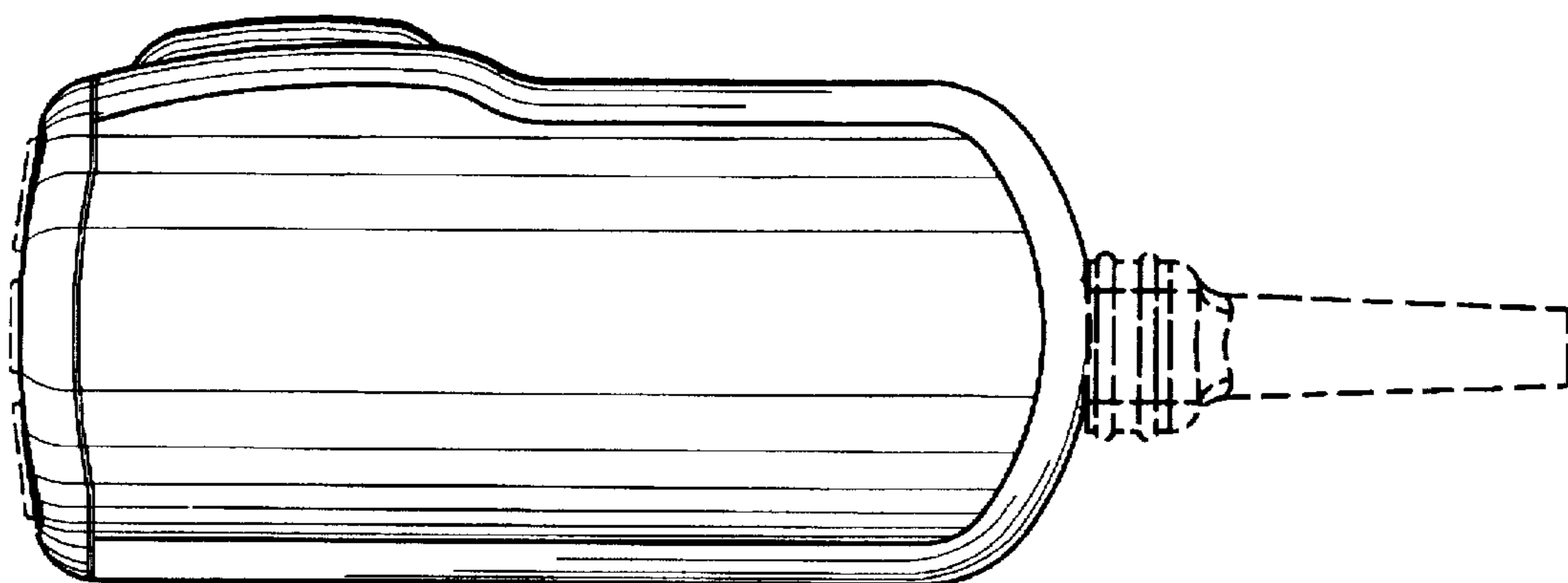

*FIG. 10*

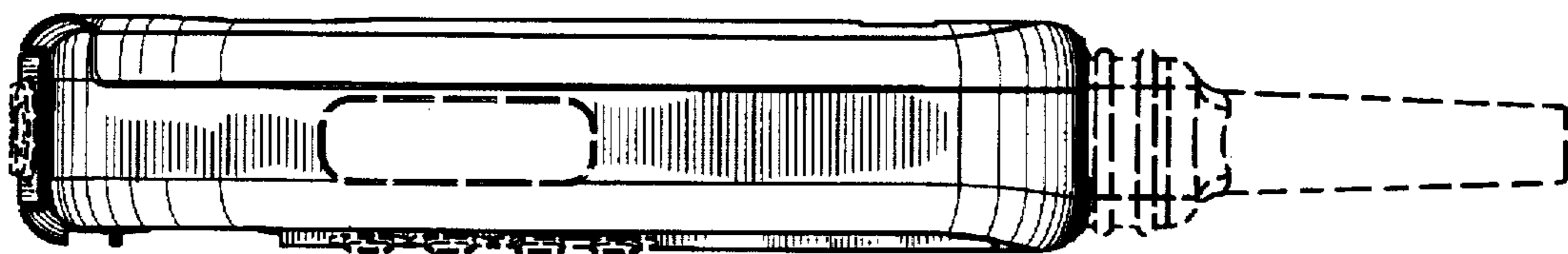

*FIG. 13*

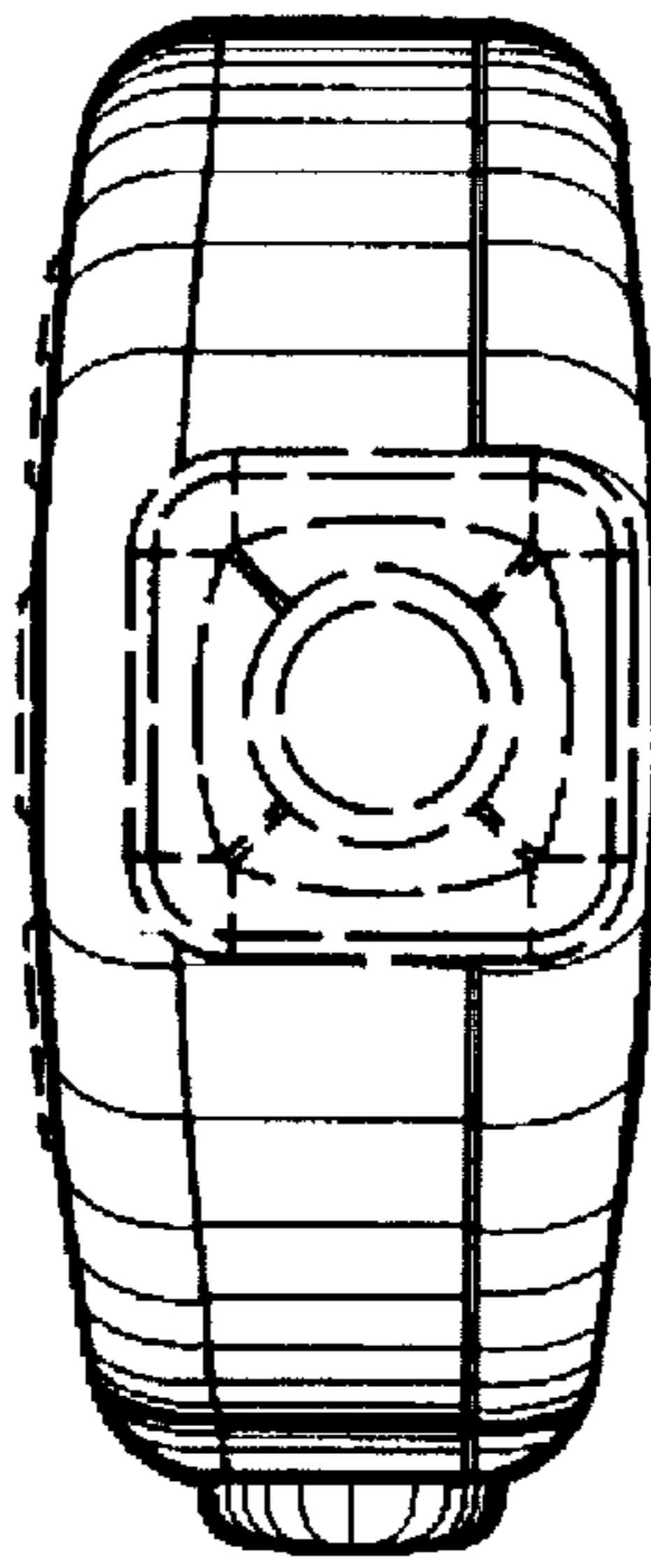

*FIG. 12*

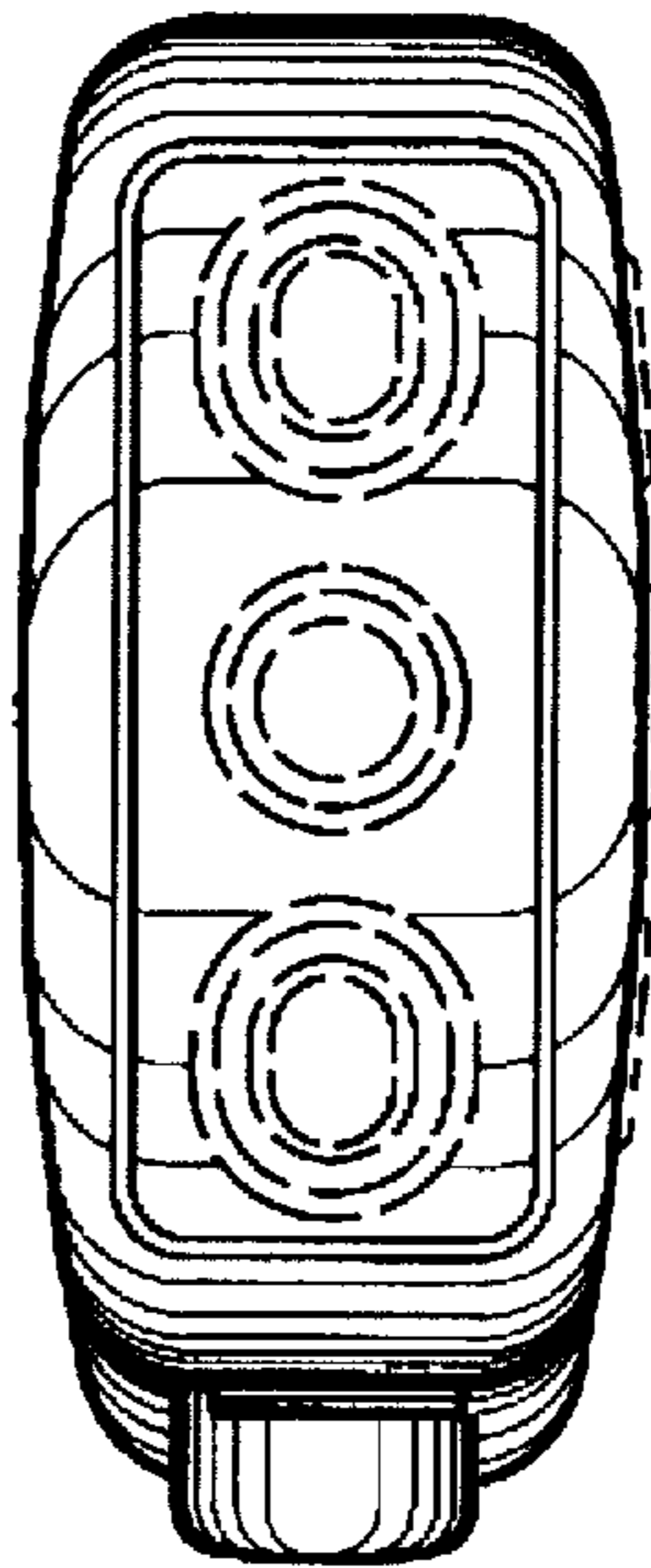



*FIG. 14*

