



US00D388086S

# United States Patent [19]

Constantine et al.

[11] Patent Number: Des. 388,086

[45] Date of Patent: \*\*Dec. 23, 1997

[54] TELEPHONE

[75] Inventors: **Richard Constantine**, Niantic;  
**Anthony Solomita**, Norwalk, both of  
Conn.

[73] Assignee: **Conair Corporation**, Stamford, Conn.

[\*\*] Term: **14 Years**

[21] Appl. No.: **60,286**

[22] Filed: **Sep. 6, 1996**

[51] LOC (6) Cl. .... **14-03**

[52] U.S. Cl. .... **D14/150; D14/148**

[58] Field of Search ..... D14/140, 142,  
D14/137, 138, 147-151, 240, 241, 251,  
253; 379/58-61, 419, 420, 428, 440, 454-455,  
434-436, 433; 455/89, 90

[56] **References Cited**

**U.S. PATENT DOCUMENTS**

D. 294,695	3/1988	Endt	.....	D14/150
D. 297,732	9/1988	Chan	.....	D14/149
D. 299,029	12/1988	Iino	.....	D14/150
D. 302,272	7/1989	Sharp, Jr.	.....	D14/149 X
D. 313,800	1/1991	Appleby	.....	D14/151
D. 344,082	2/1994	Lafreniere et al.	.....	D14/149 X
D. 353,374	12/1994	Heijnen	.....	D14/148 X
D. 361,330	8/1995	Solomita et al.	.....	D14/148 X

**OTHER PUBLICATIONS**

B.A.Pargh 1985 Spring/Summer Catalog, p. 272, Sanyo Telephone Item TH1015.

B.A.Pargh 1985 Spring/Summer Catalog, p. 245, Webcor Telephone Item 707BR.

B.A.Pargh 1985 Spring/Summer Catalog, p. 241, Phone-mate Telephone Item IQ700AL.

*Primary Examiner*—Jeffrey Asch  
*Attorney, Agent, or Firm*—Ohlandt, Greeley, Ruggiero & Perle

[57] **CLAIM**

The ornamental design for a telephone, as shown and described.

**DESCRIPTION**

FIG. 1 is a top perspective view of a telephone showing our new design;

FIG. 2 is a top perspective view of the base unit of the telephone of FIG. 1;

FIG. 3 is a top plan view of the base unit of FIG. 2;

FIG. 4 is a front elevational view of the base unit of FIG. 2;

FIG. 5 is a right side elevational view of the base unit of FIG. 2;

FIG. 6 is a left side elevational view of the base unit of FIG. 2;

FIG. 7 is a bottom plan view of the base unit of FIG. 2;

FIG. 8 is a rear elevational view of the base unit of FIG. 2;

FIG. 9 is a bottom perspective view of the handset of the telephone of FIG. 1;

FIG. 10 is a top plan view of the handset of FIG. 9;

FIG. 11 is a front elevational view of the handset of FIG. 9;

FIG. 12 is a left side elevational view of the handset of FIG. 9, the right side elevational view being a mirror image thereof;

FIG. 13 is a bottom plan view of the handset of FIG. 9; and,

FIG. 14 is a rear elevational view of the handset of FIG. 9.

The telephone base and handset have been shown separately in FIGS. 2-8 and 9-14 for convenience of illustration.

**1 Claim, 6 Drawing Sheets**

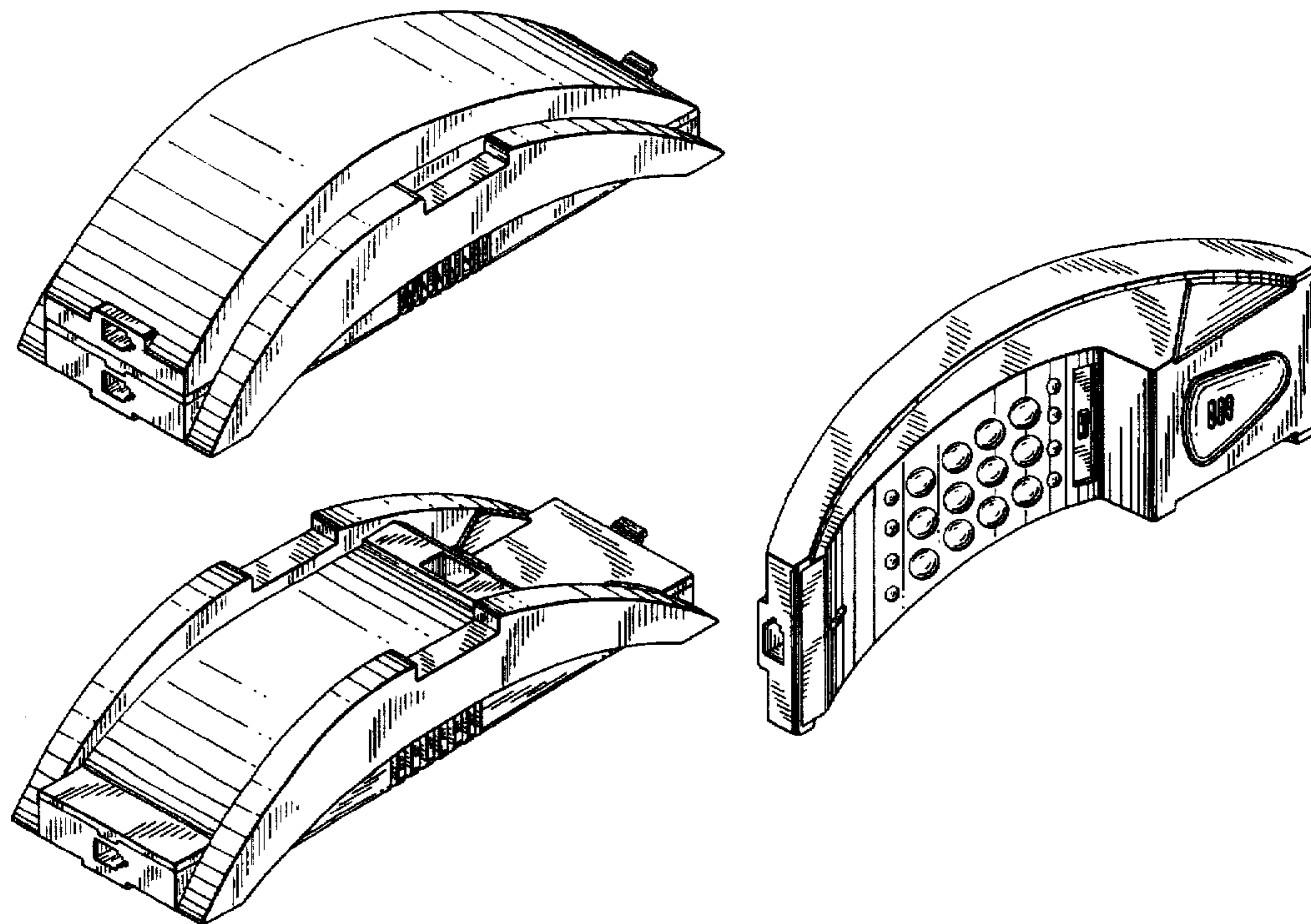

FIG. 1

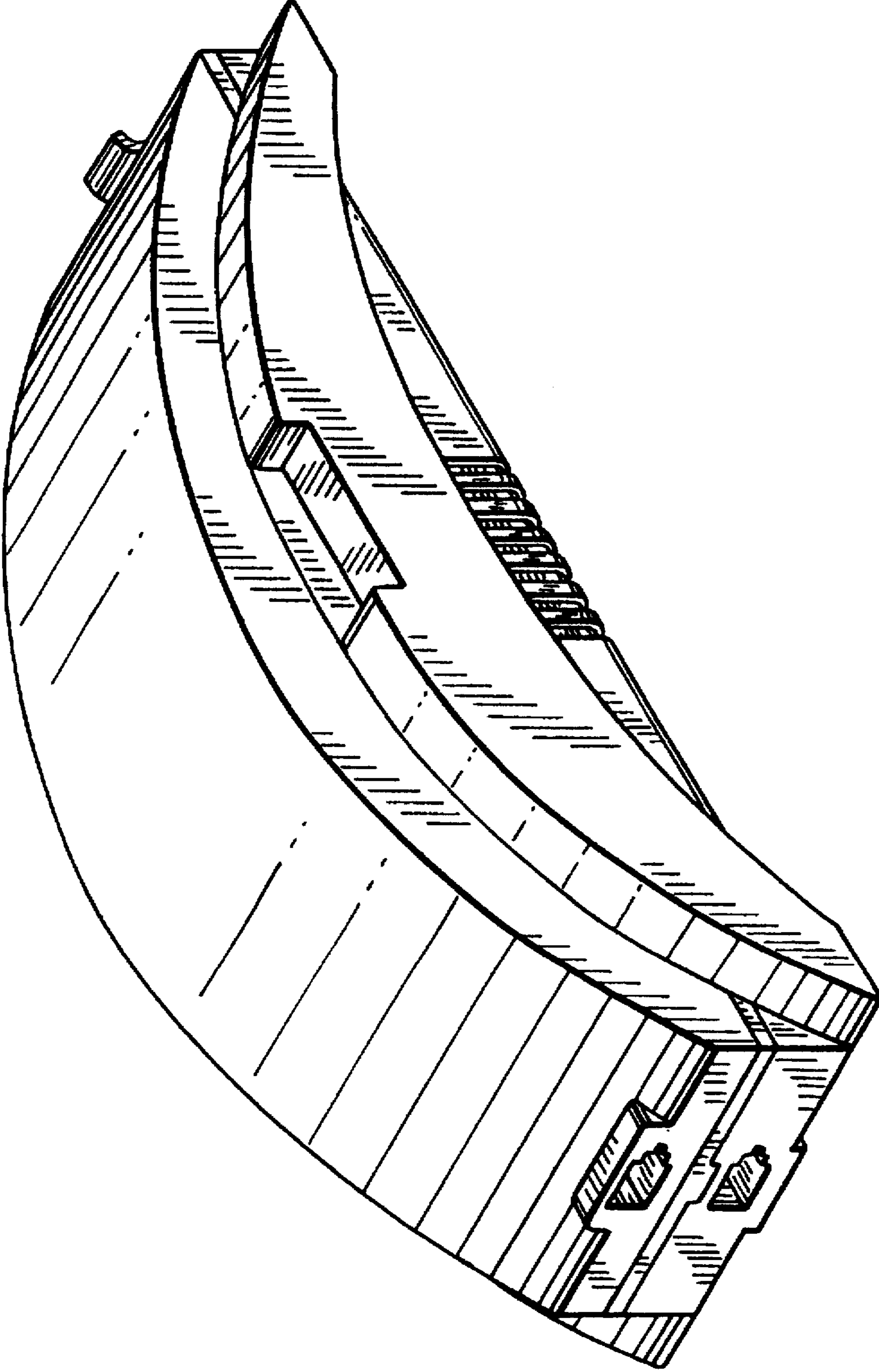
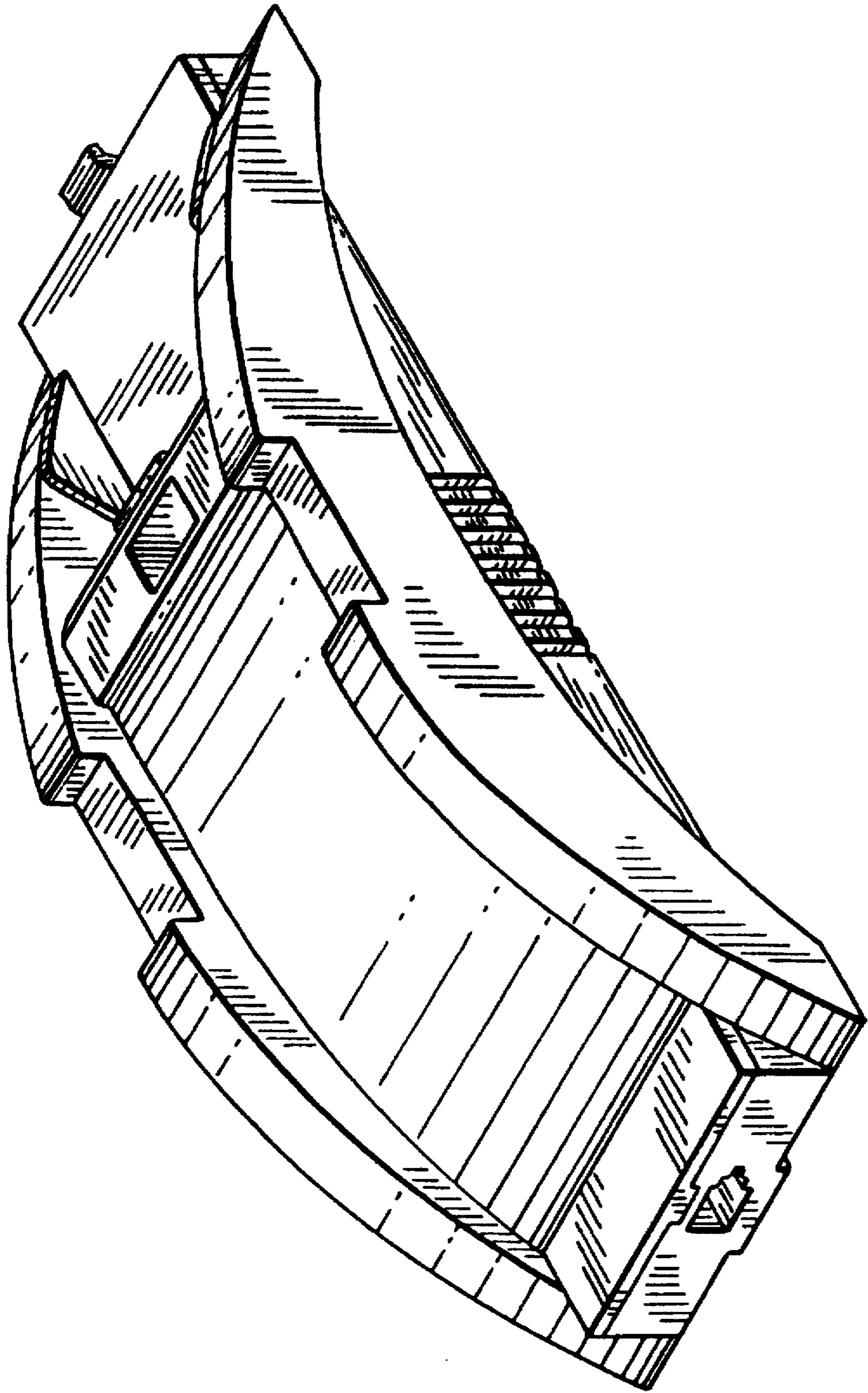

FIG. 2





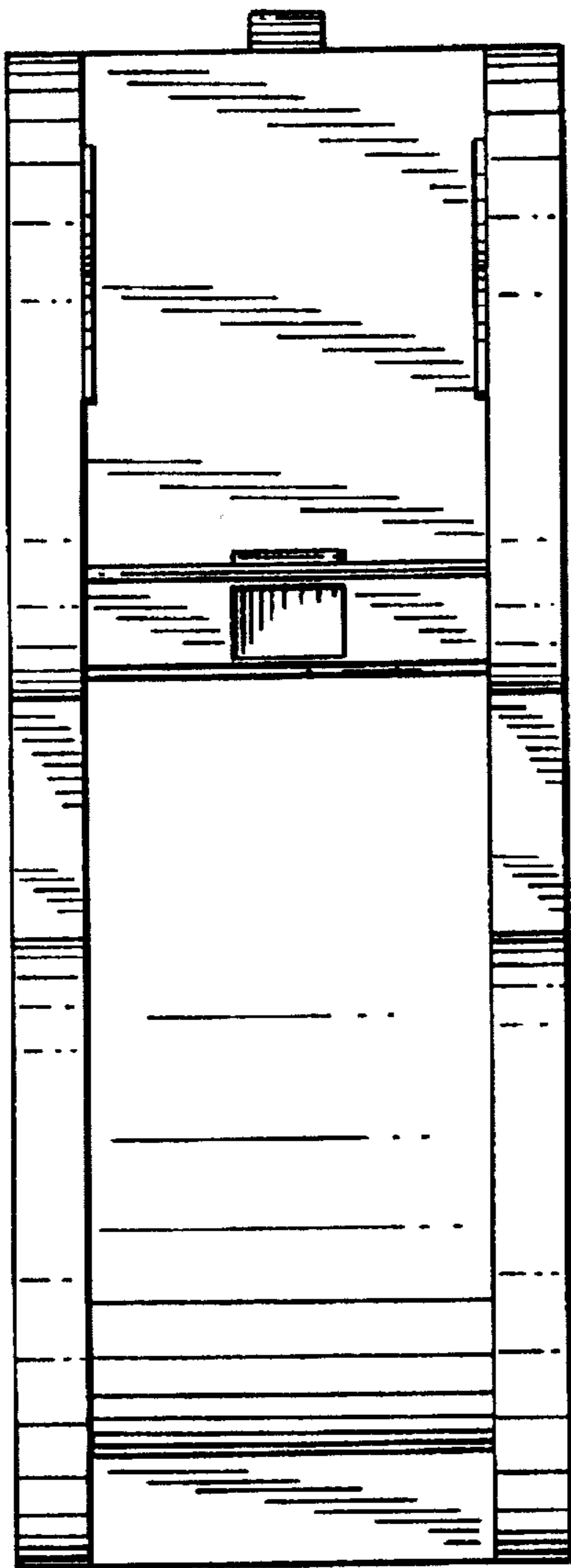

FIG. 3

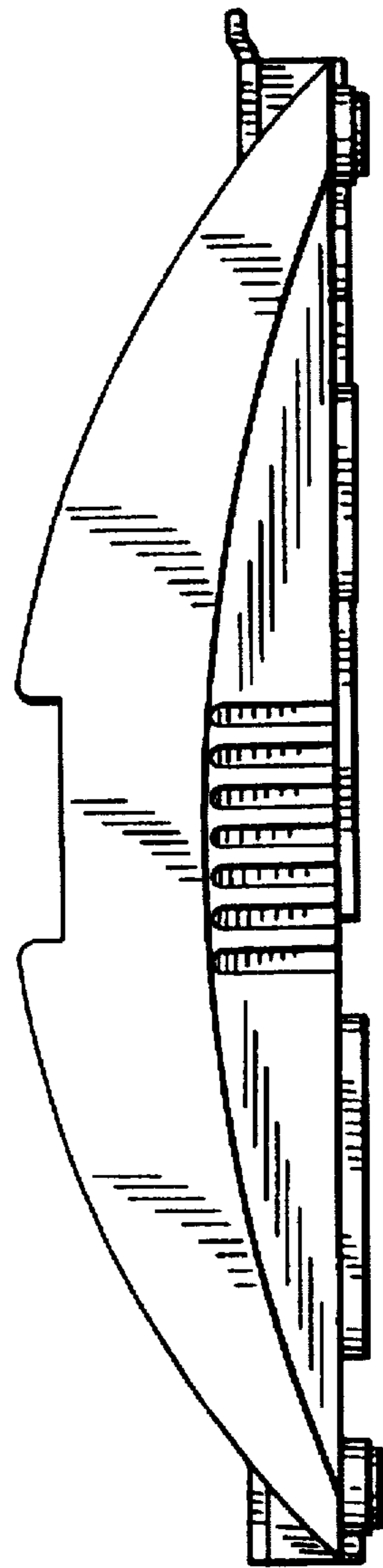

FIG. 5

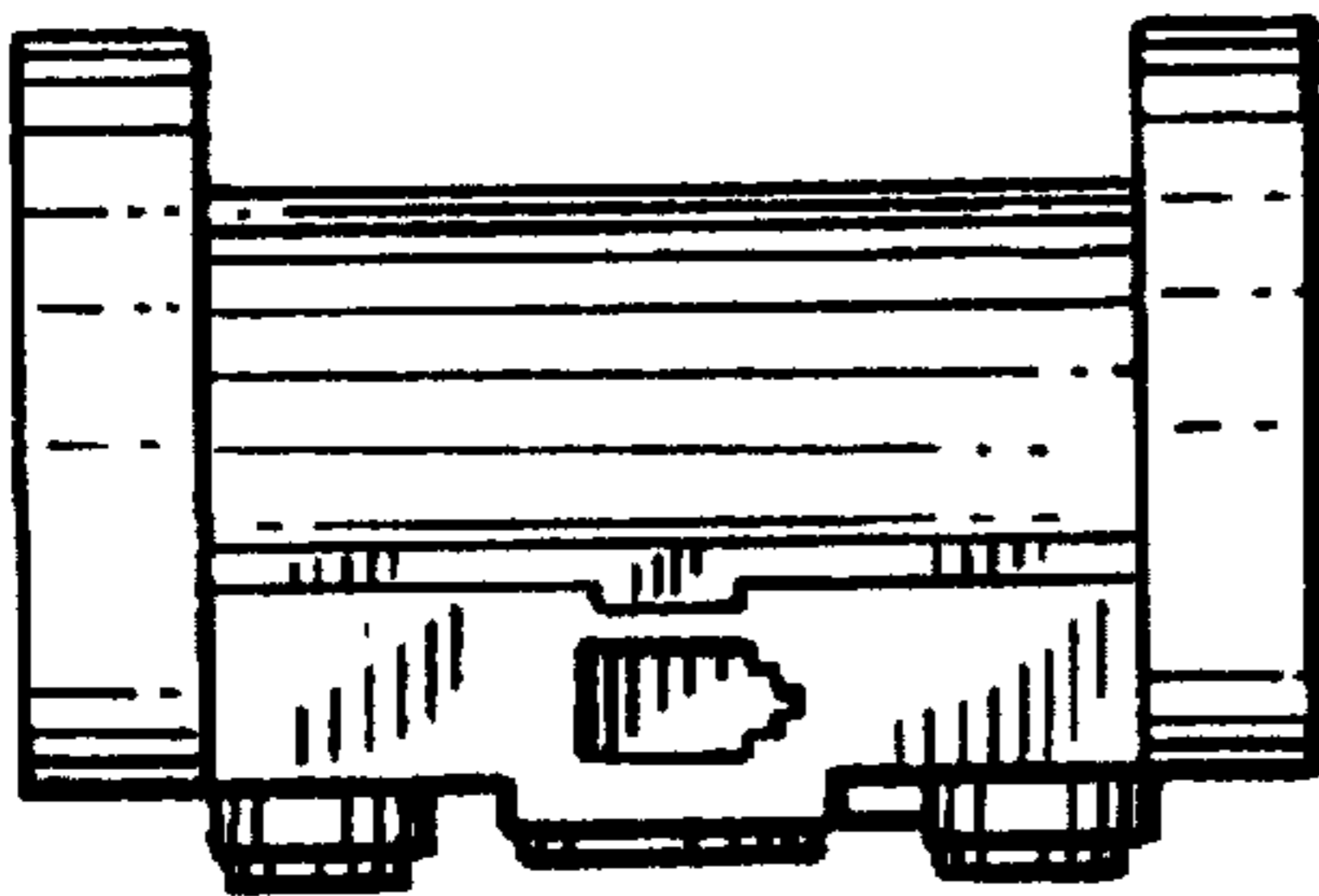

FIG. 4

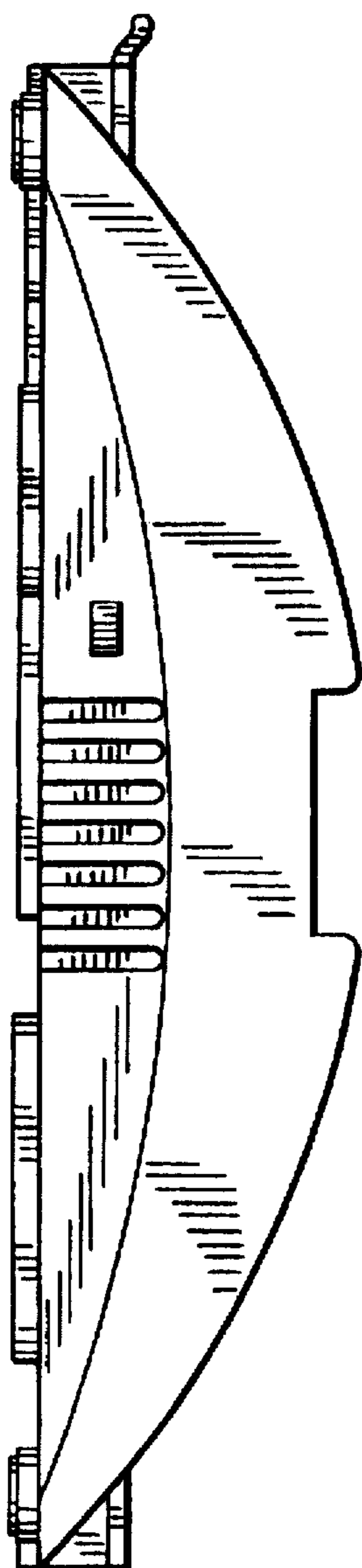

FIG. 6

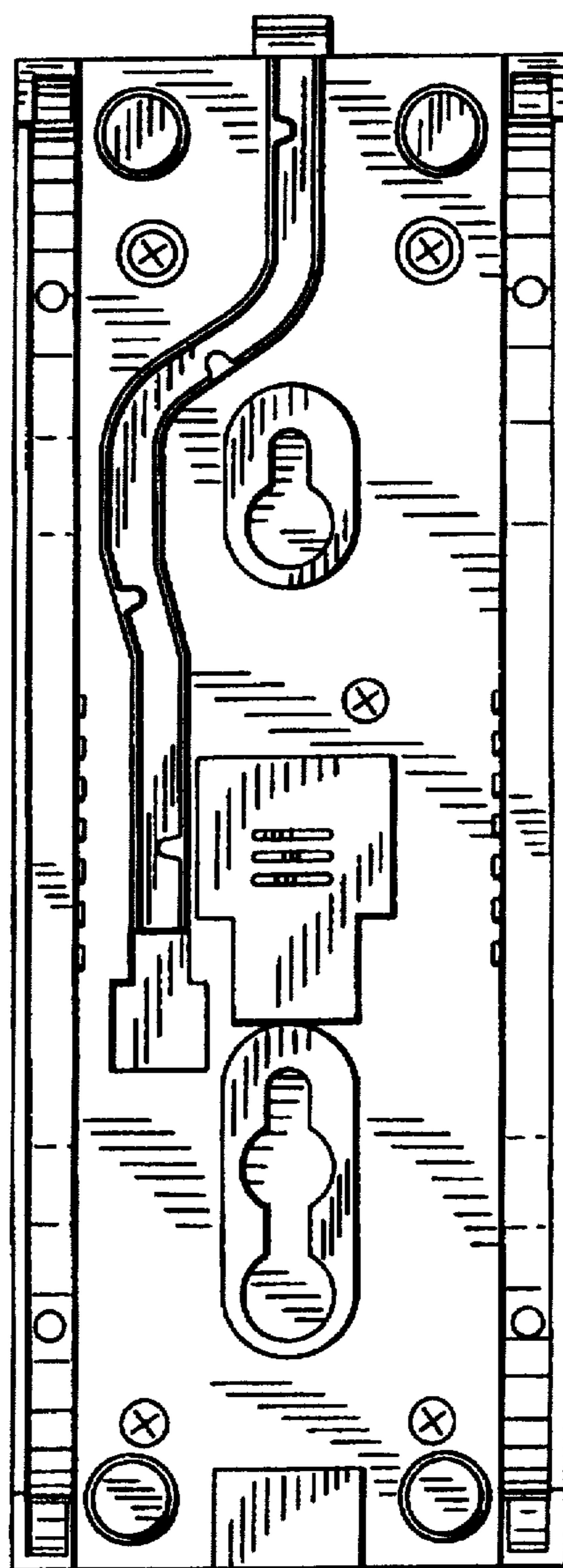

FIG. 7

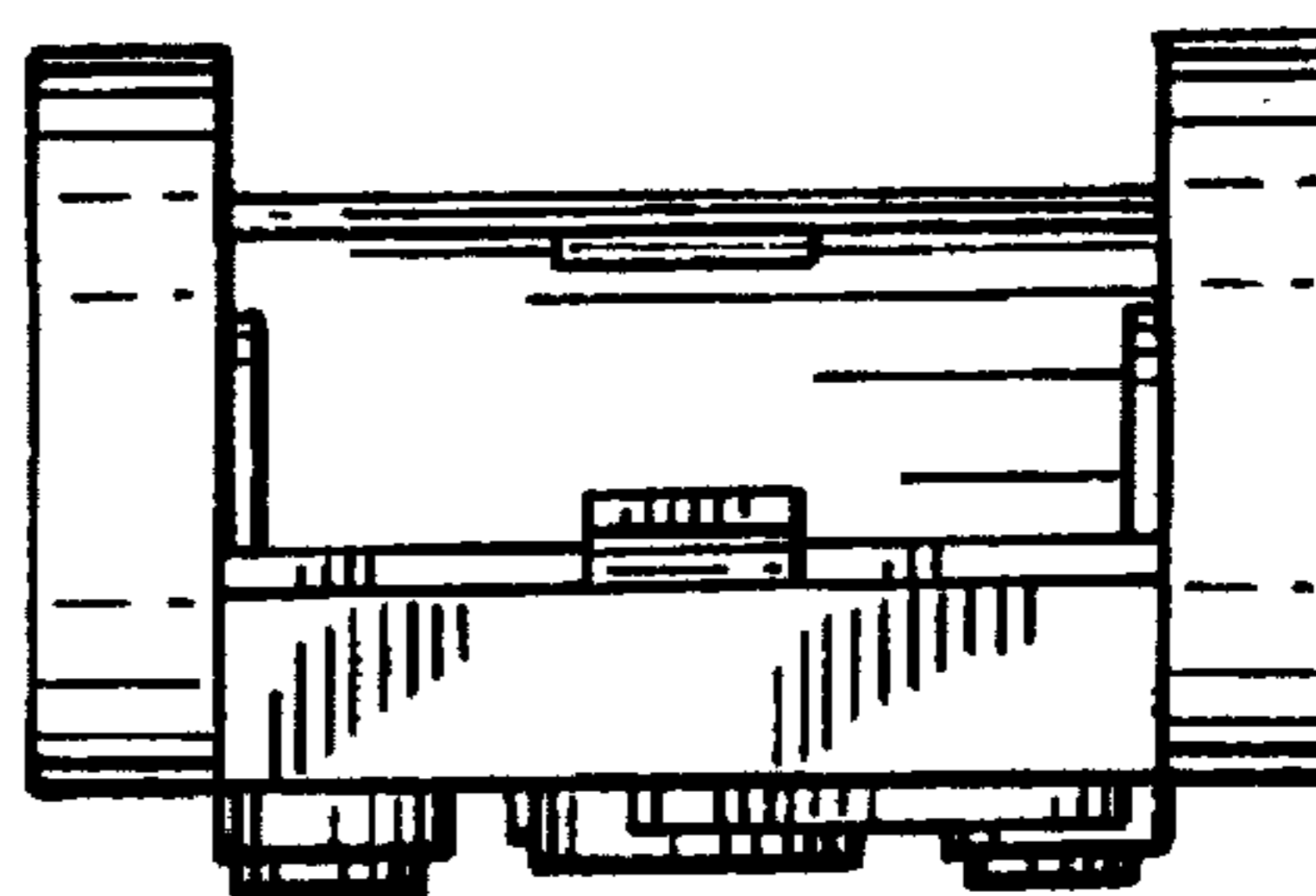

FIG. 8

FIG. 9

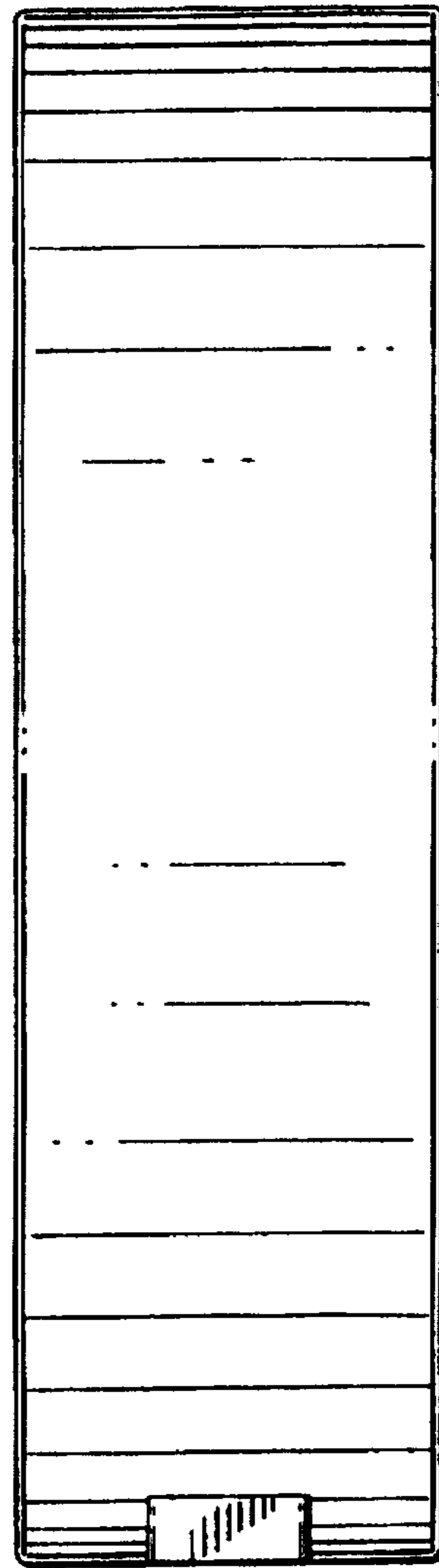
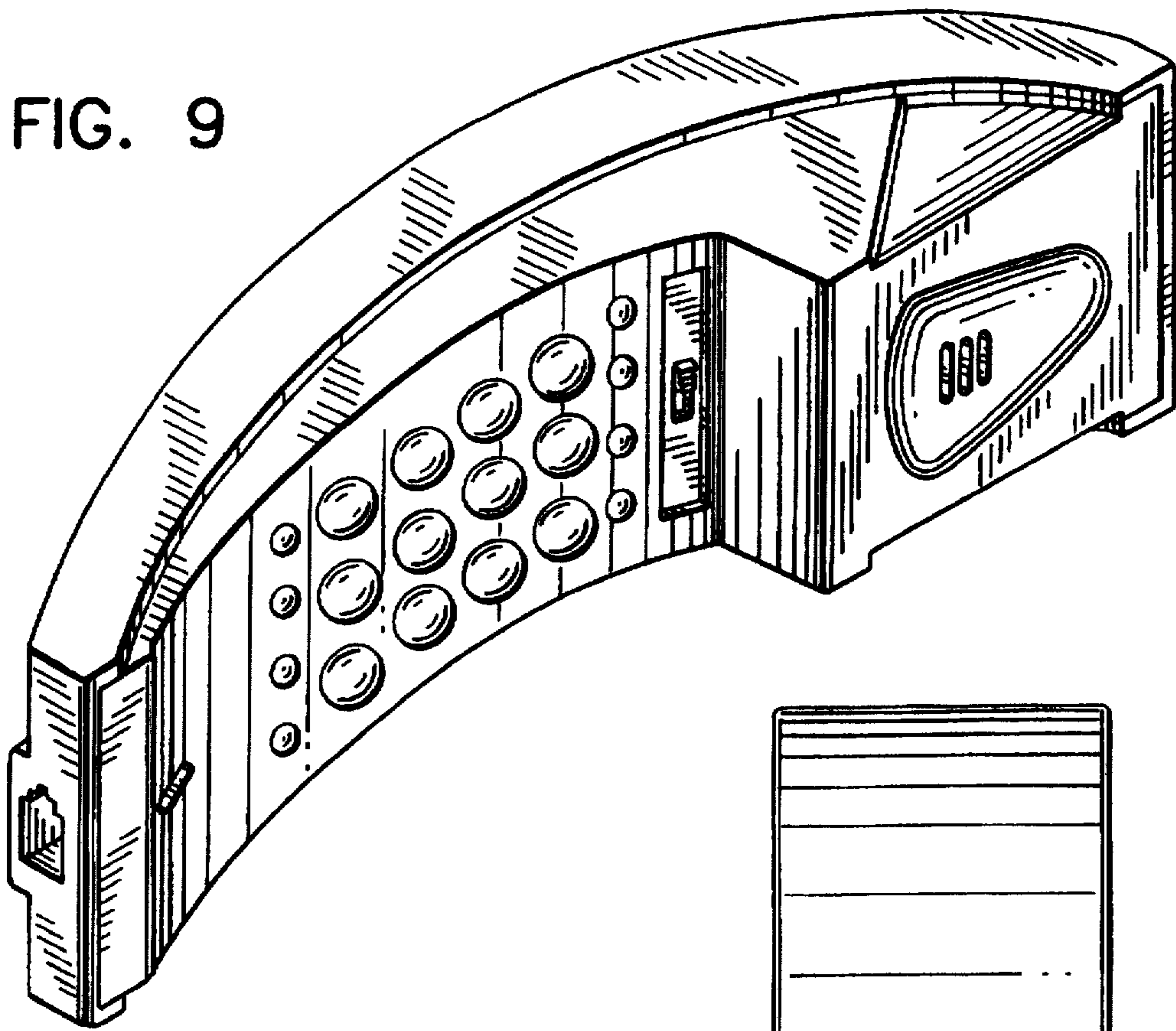

FIG. 10

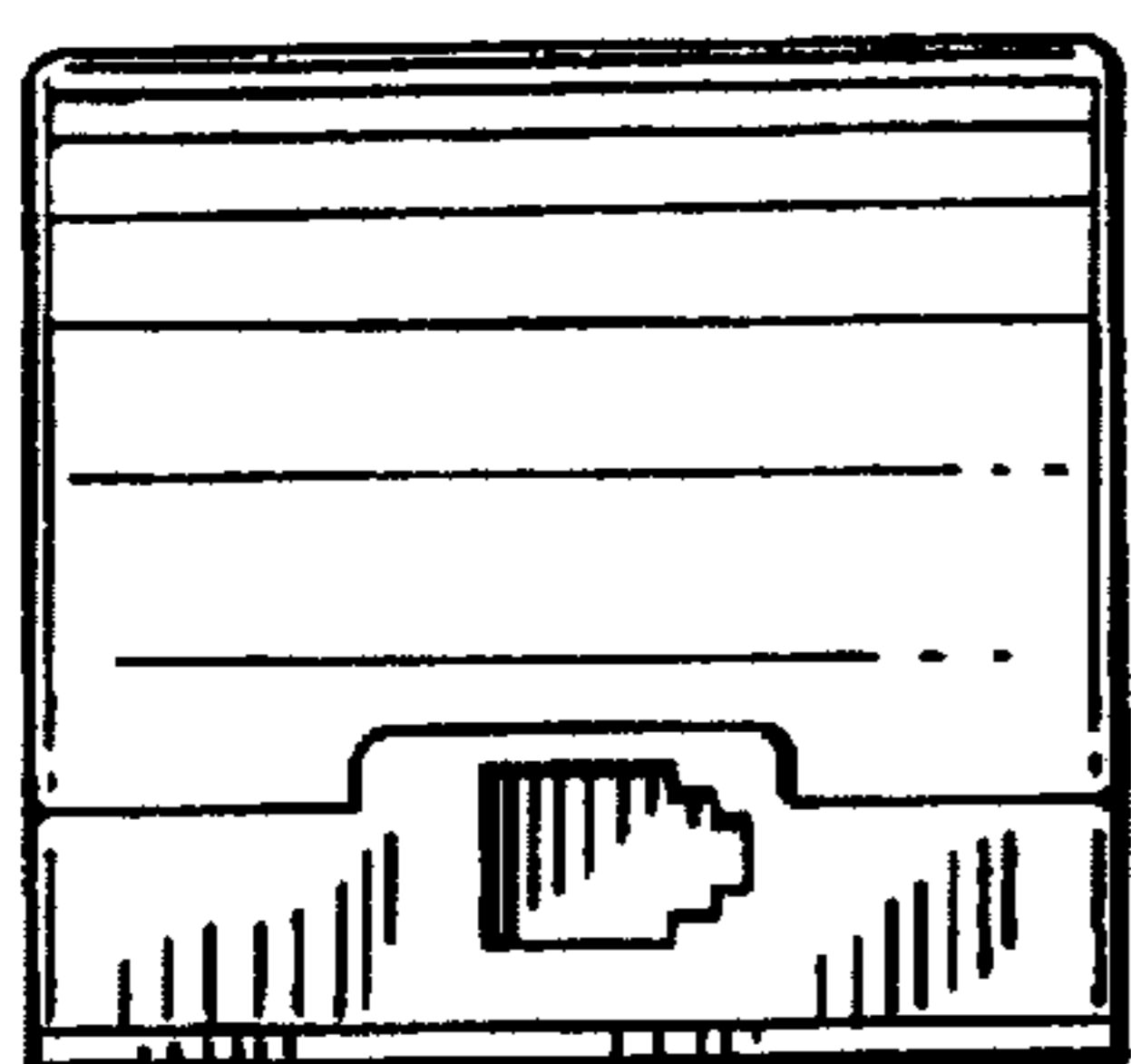

FIG. 11

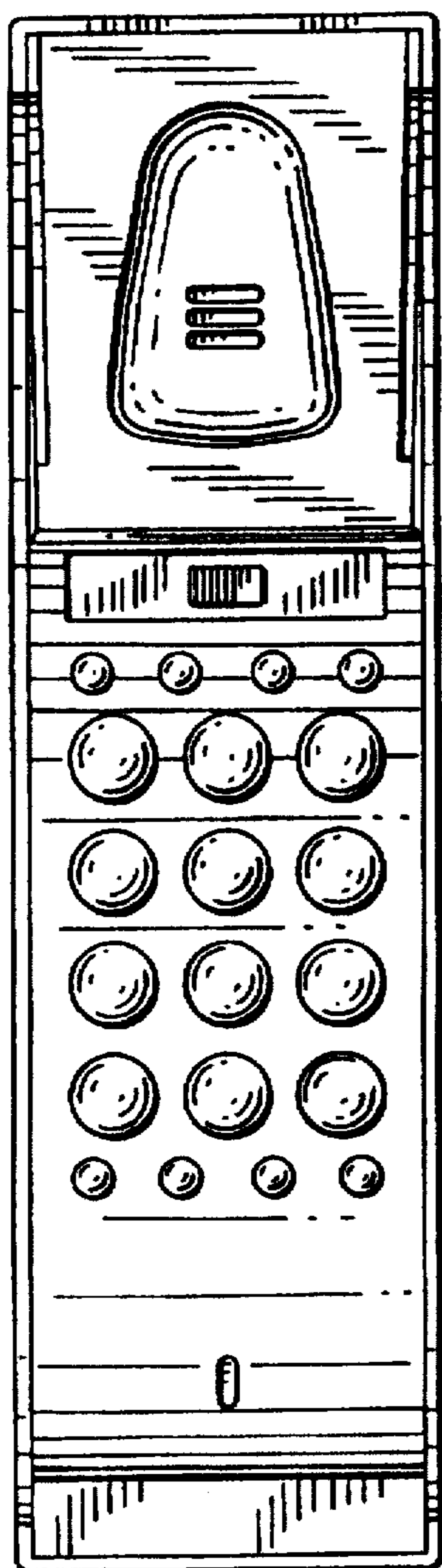

FIG. 13

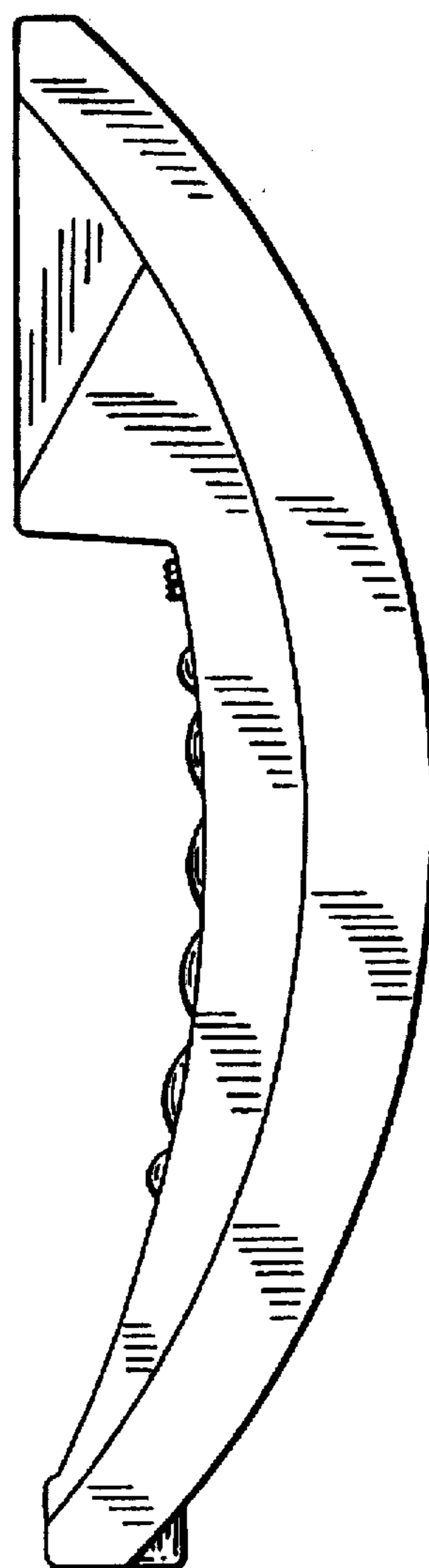

FIG. 12

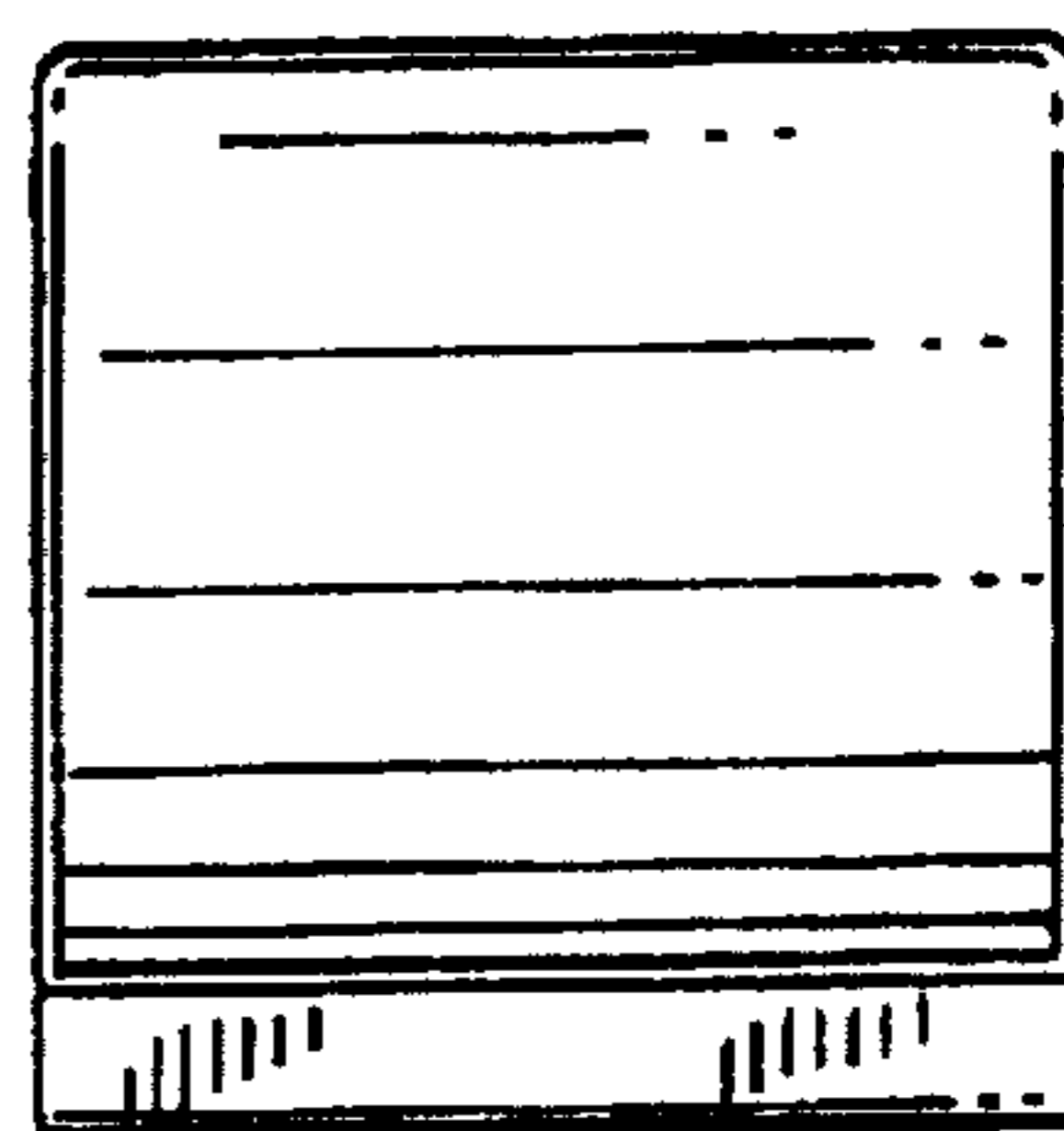

FIG. 14