

US00D388083S

United States Patent [19] Chung

[11] Patent Number: Des. 388,083
[45] Date of Patent: **Dec. 23, 1997

[54] COIN PHONE

[76] Inventor: **Johnny Chung**, 6F-3, No. 296, Sec. 2,
Chung Shan Road, Chung Ho City,
Taipei Hsien, Taiwan

[**] Term: 14 Years

[21] Appl. No.: 64,426

[22] Filed: Dec. 31, 1996

[51] LOC (6) Cl. 14-03

[52] U.S. Cl. D14/146

[58] Field of Search D14/140, 142,
D14/146, 149-151; D21/111; D99/28; 379/143-145,
417, 420, 428, 440, 434, 436

[56] **References Cited**

U.S. PATENT DOCUMENTS

D. 305,332	1/1990	Schremmer et al.	D14/146
D. 305,653	1/1990	Rose	D14/142
D. 306,443	3/1990	Su	D14/146
D. 315,485	3/1991	Schremmer et al.	D14/146

D. 342,251	12/1993	Hird et al.	D14/146
D. 359,489	6/1995	Kwon et al.	D14/146
D. 375,307	11/1996	Lamora	D14/146
4,974,257	11/1990	Ibanez et al.	379/143

Primary Examiner—Jeffrey Asch
Attorney, Agent, or Firm—Morton J. Rosenberg; David I. Klein

[57] **CLAIM**

The ornamental design for a coin phone, as shown and described.

DESCRIPTION

FIG. 1 is a top, front and right side perspective view of a coin phone showing my new design;
FIG. 2 is a front elevational view thereof;
FIG. 3 is a rear elevational view thereof;
FIG. 4 is a top plan view thereof;
FIG. 5 is a bottom plan view thereof;
FIG. 6 is a left side elevational view thereof; and,
FIG. 7 is a right side elevational view thereof.

1 Claim, 7 Drawing Sheets

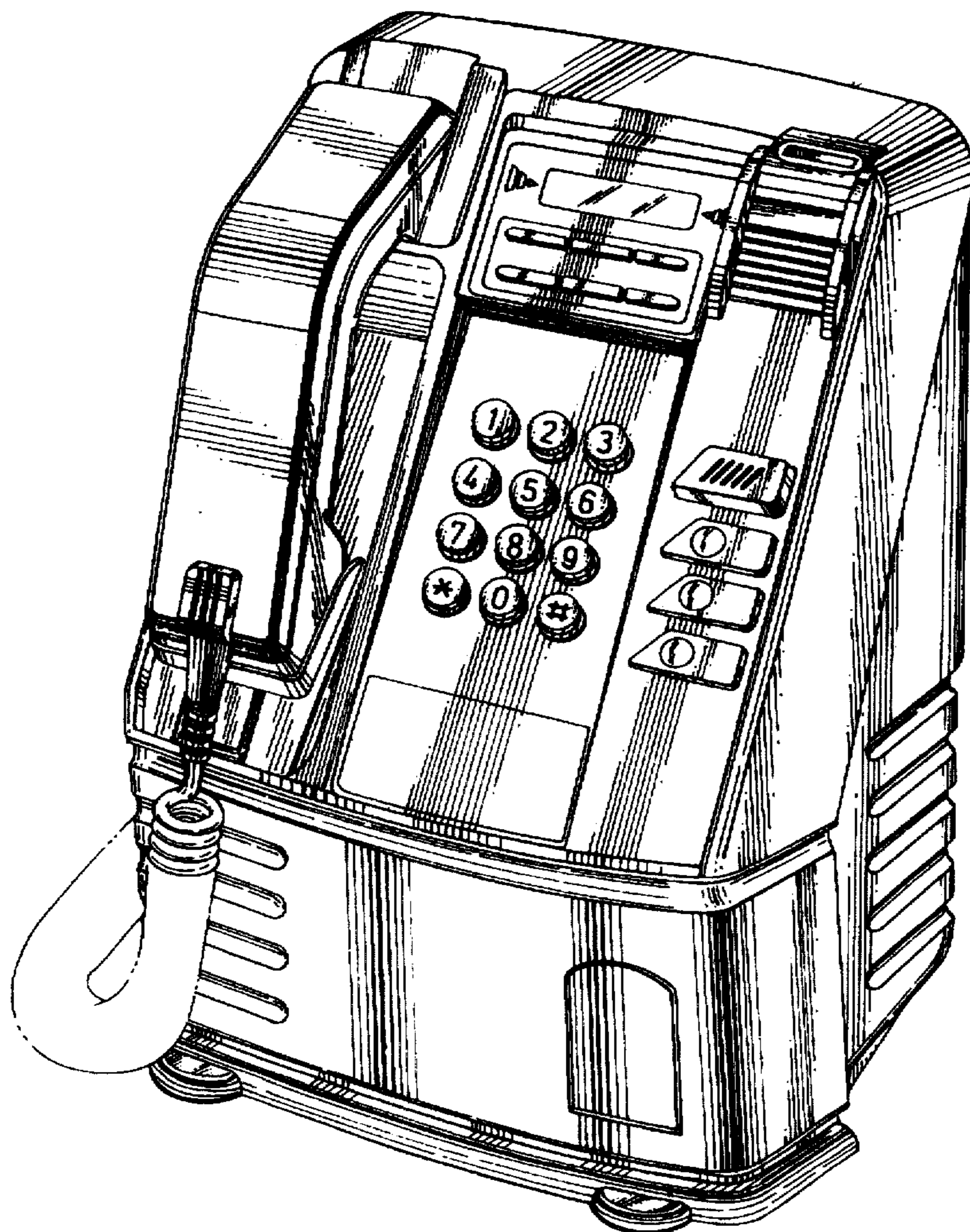

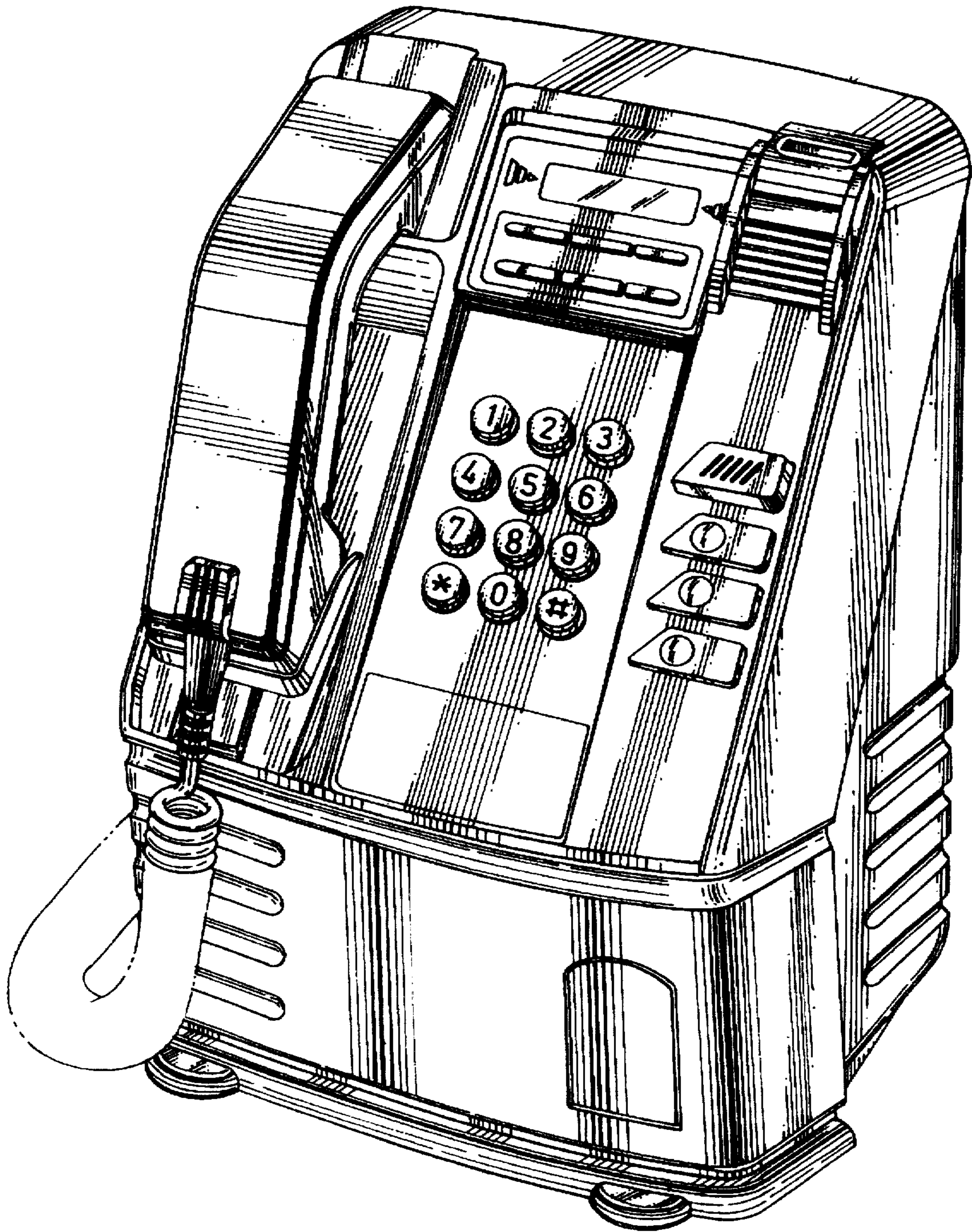

FIG. 1

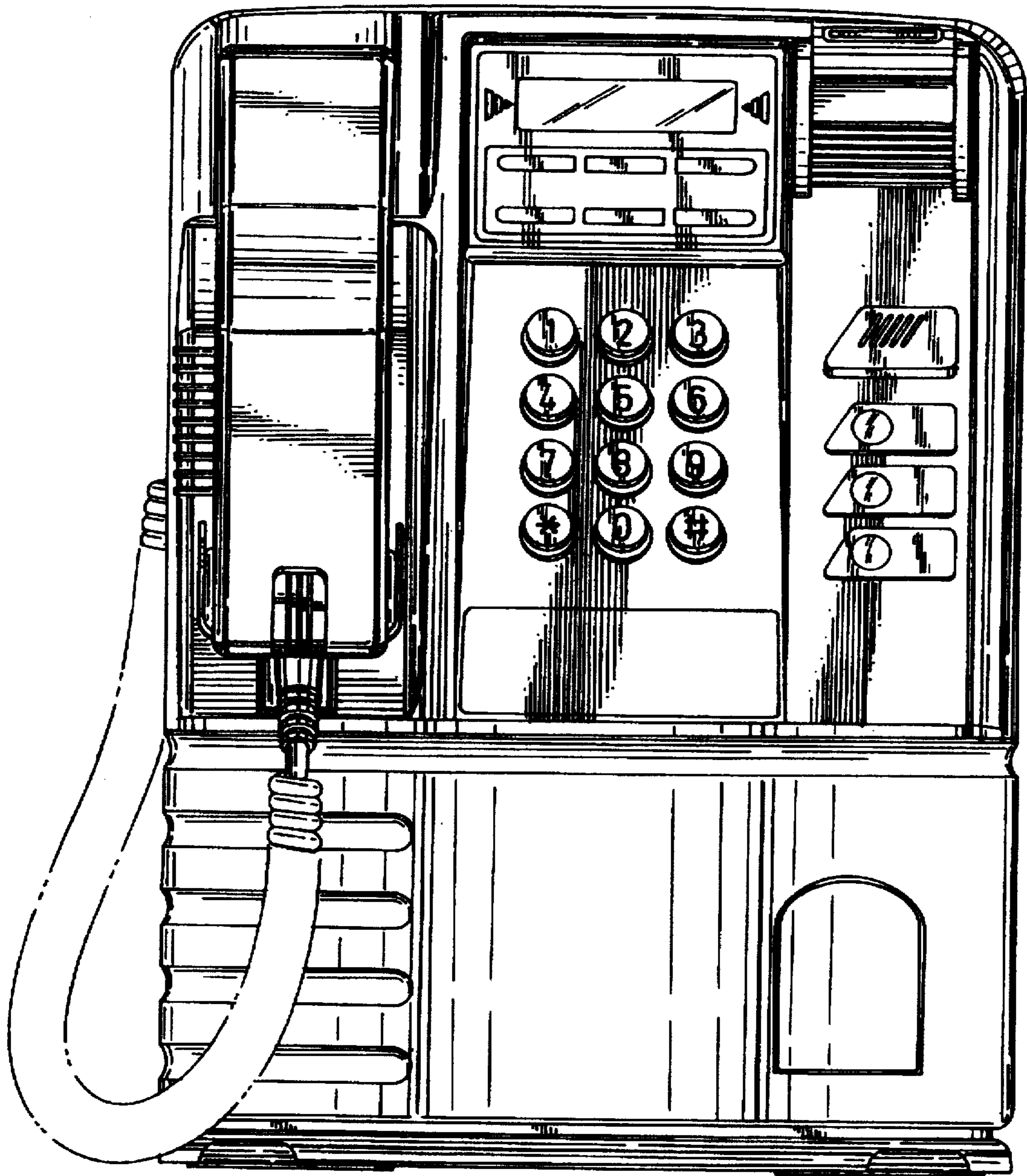

FIG. 2

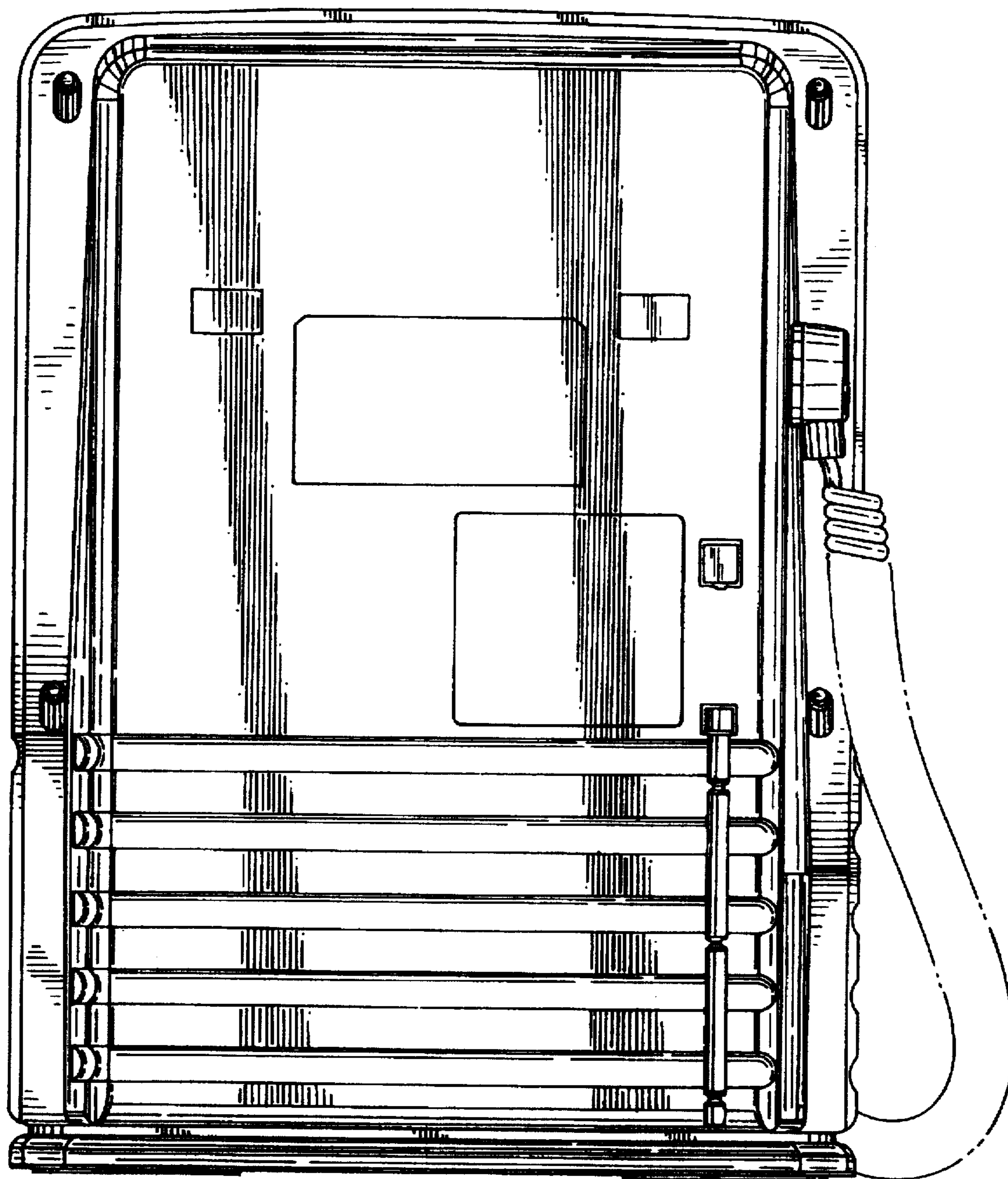

FIG. 3

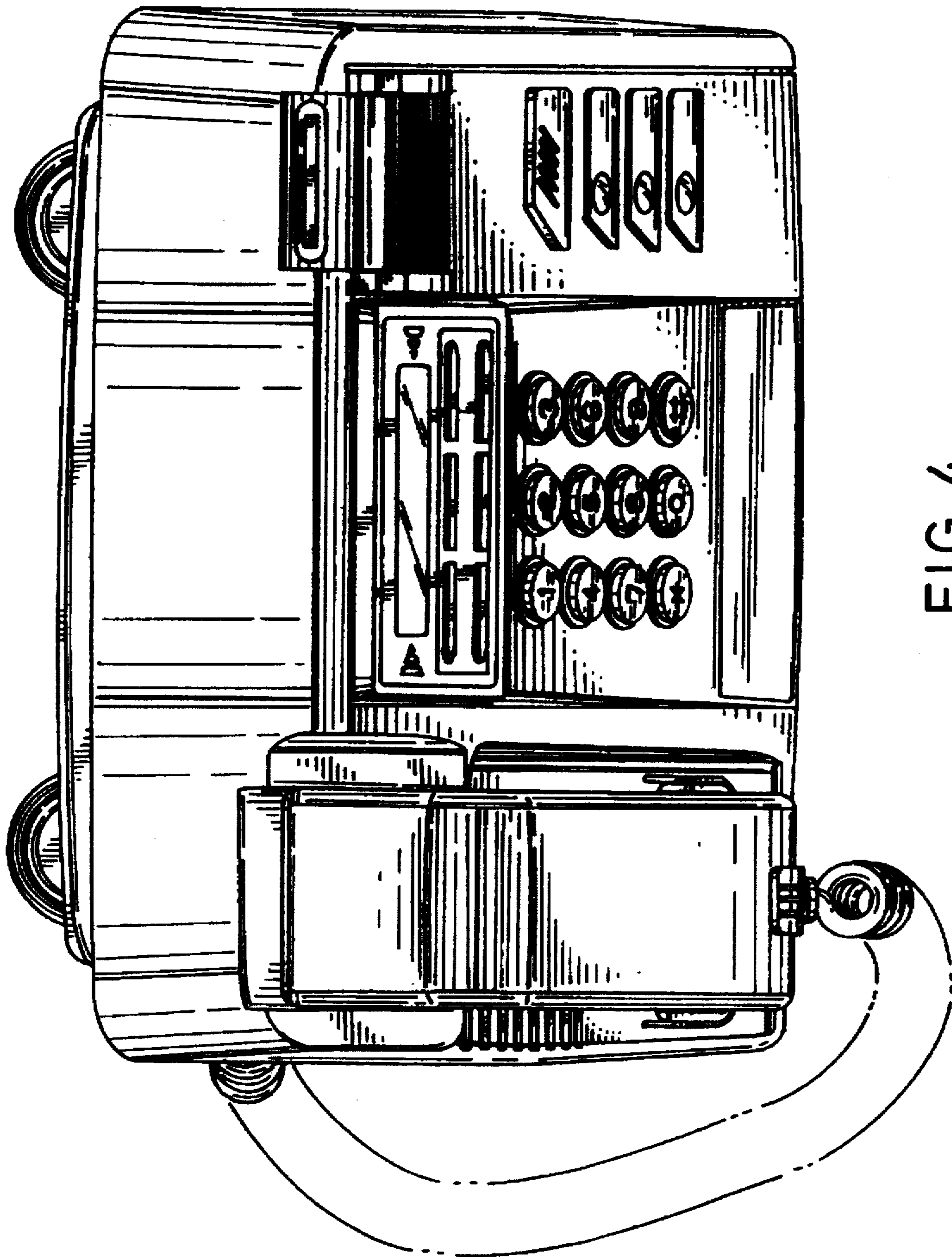

FIG. 4

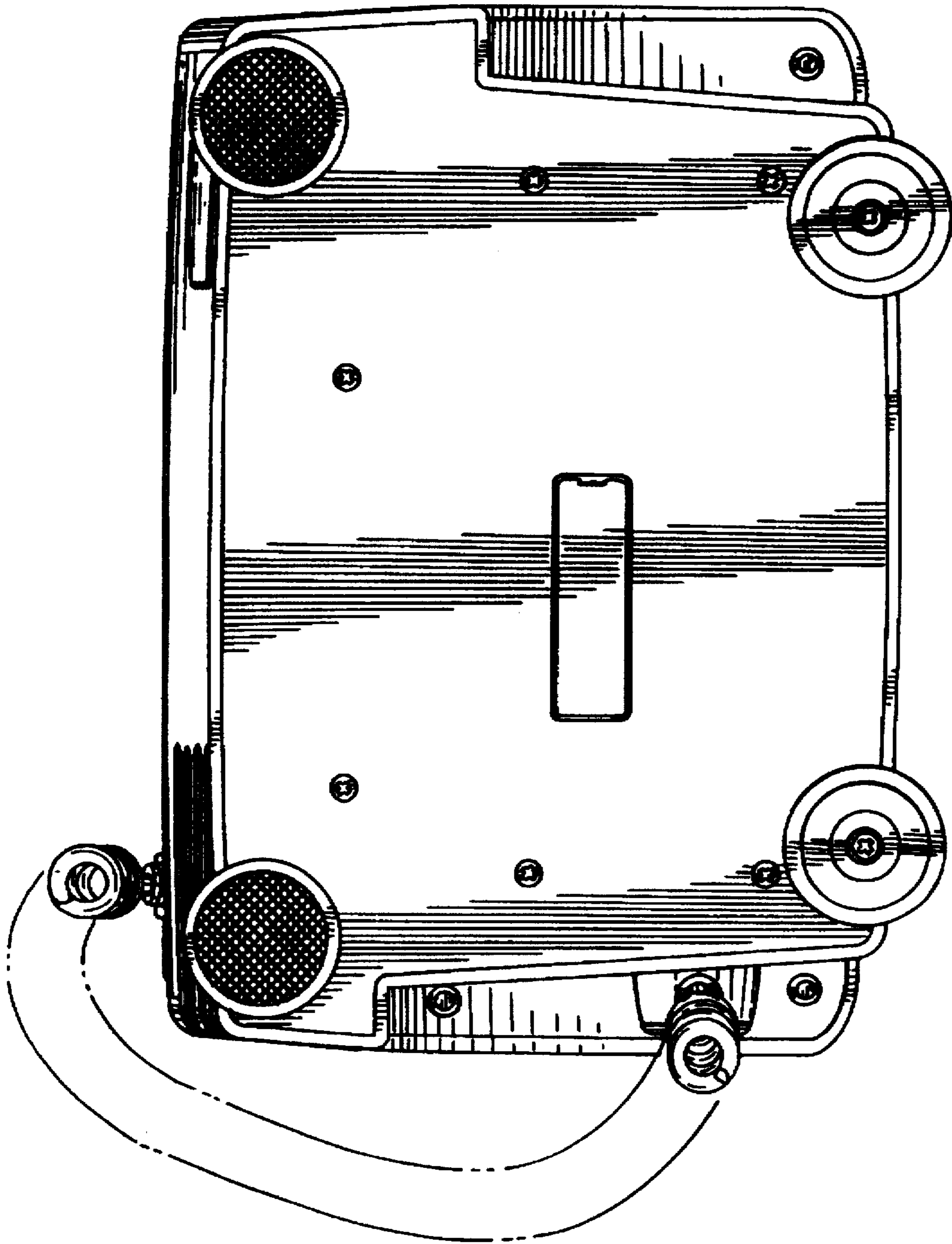

FIG. 5

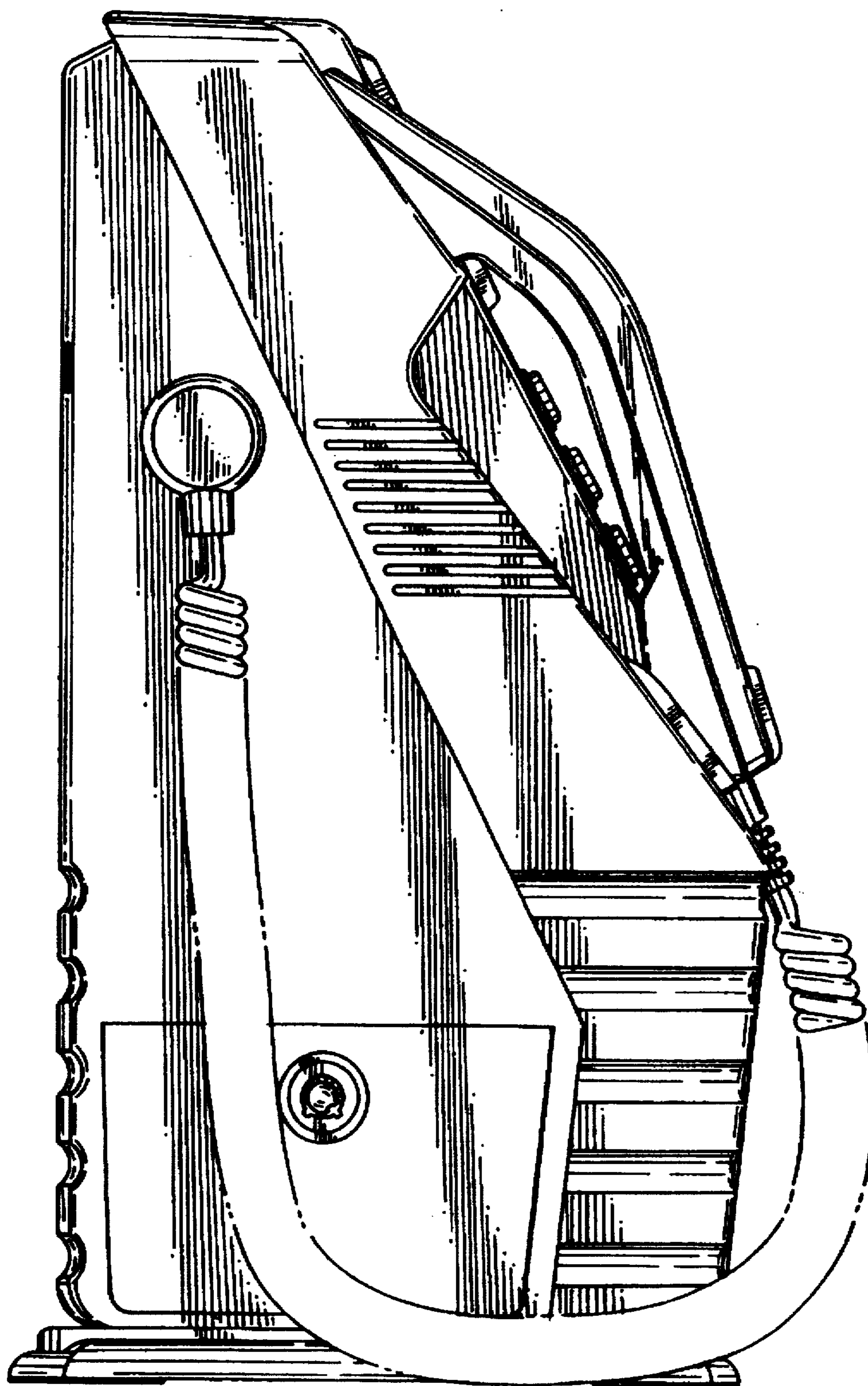

FIG. 6

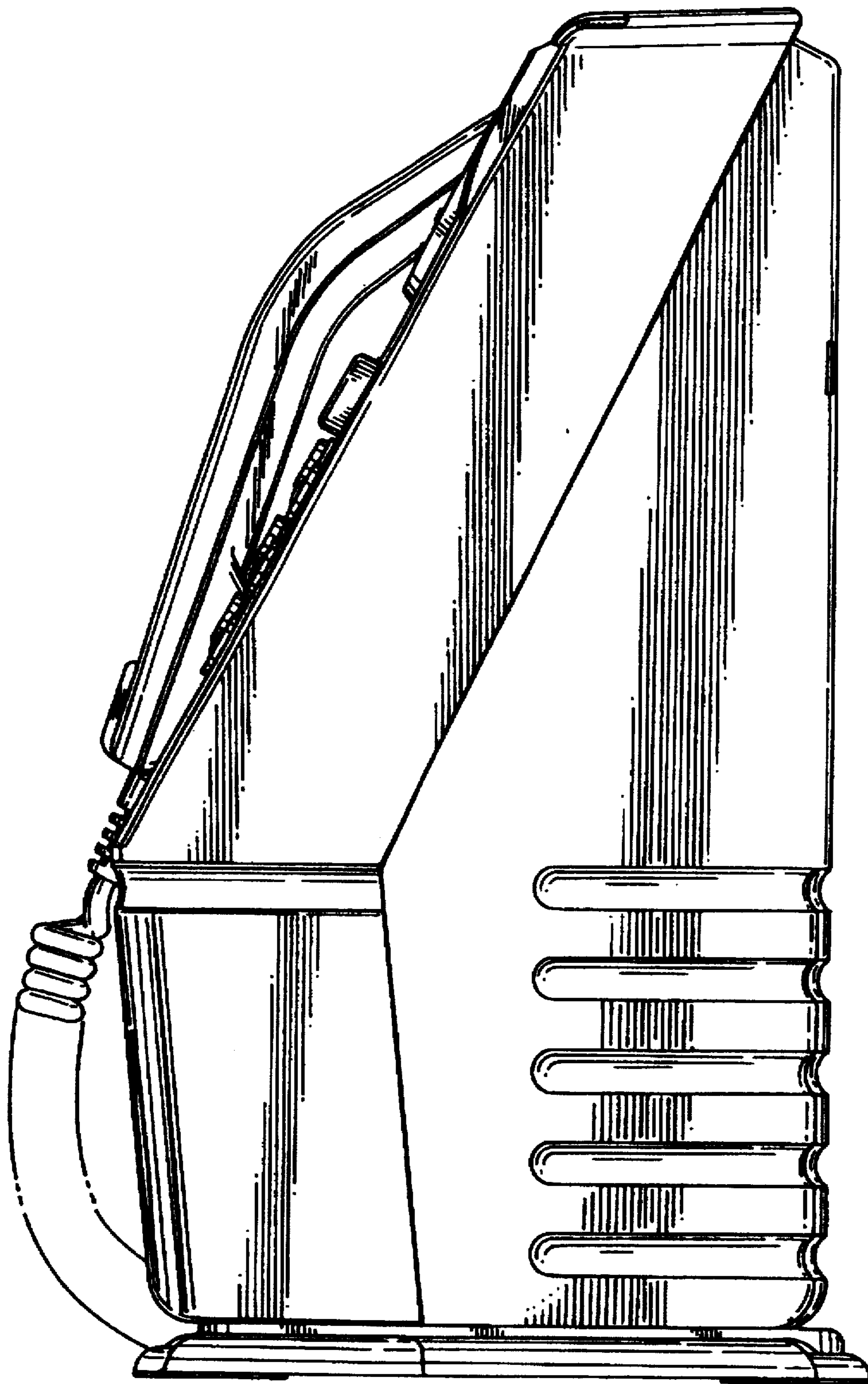

FIG. 7