

US00D388077S

# United States Patent [19] Starck

[11] Patent Number: **Des. 388,077**  
[45] Date of Patent: **\*\*Dec. 23, 1997**

[54] **SCREEN FOR A TELEVISION SET**  
[75] Inventor: **Philippe Starck**, Issy-les-Moulineaux, France  
[73] Assignee: **Thomson Multimedia (Societe Anonyme)**, Courbevoie, France  
[\*\*] Term: **14 Years**  
[21] Appl. No.: **61,221**  
[22] Filed: **Oct. 18, 1996**  
[30] **Foreign Application Priority Data**  
Apr. 19, 1996 [FR] France ..... 96 2408  
[51] LOC (6) Cl. .... **14-03**  
[52] U.S. Cl. .... **D14/126; D6/300; D11/132; D14/113**  
[58] **Field of Search** ..... D14/106, 113, D14/124-134; D18/1, 11; D19/59, 60; D6/300, 310, 311; D11/132; 312/7.2; 348/836, 838

D. 323,324 1/1992 Suda ..... D14/125  
D. 348,055 6/1994 Basco et al. .... D14/113  
D. 356,081 3/1995 Naito et al. .... D14/129

### OTHER PUBLICATIONS

Schoner Wohnen, Apr. 1989, p. 121.

*Primary Examiner*—Prabhakar G. Deshmukh  
*Assistant Examiner*—Richelle Shelton  
*Attorney, Agent, or Firm*—McAulay Fisher Nissen Goldberg & Kiel, LLP

### [57] CLAIM

The ornamental design for a screen for a television set, as shown and described.

### DESCRIPTION

FIG. 1 is a front elevational view of a screen for a television set showing my new design;  
FIG. 2 is a top plan view thereof;  
FIG. 3 is a right side elevational view thereof and the left side elevational view is identical;  
FIG. 4 is a bottom plan thereof; and,  
FIG. 5 is a rear elevational view thereof.

[56] **References Cited**  
**U.S. PATENT DOCUMENTS**  
D. 268,570 4/1983 Wagman ..... D11/132

**1 Claim, 3 Drawing Sheets**

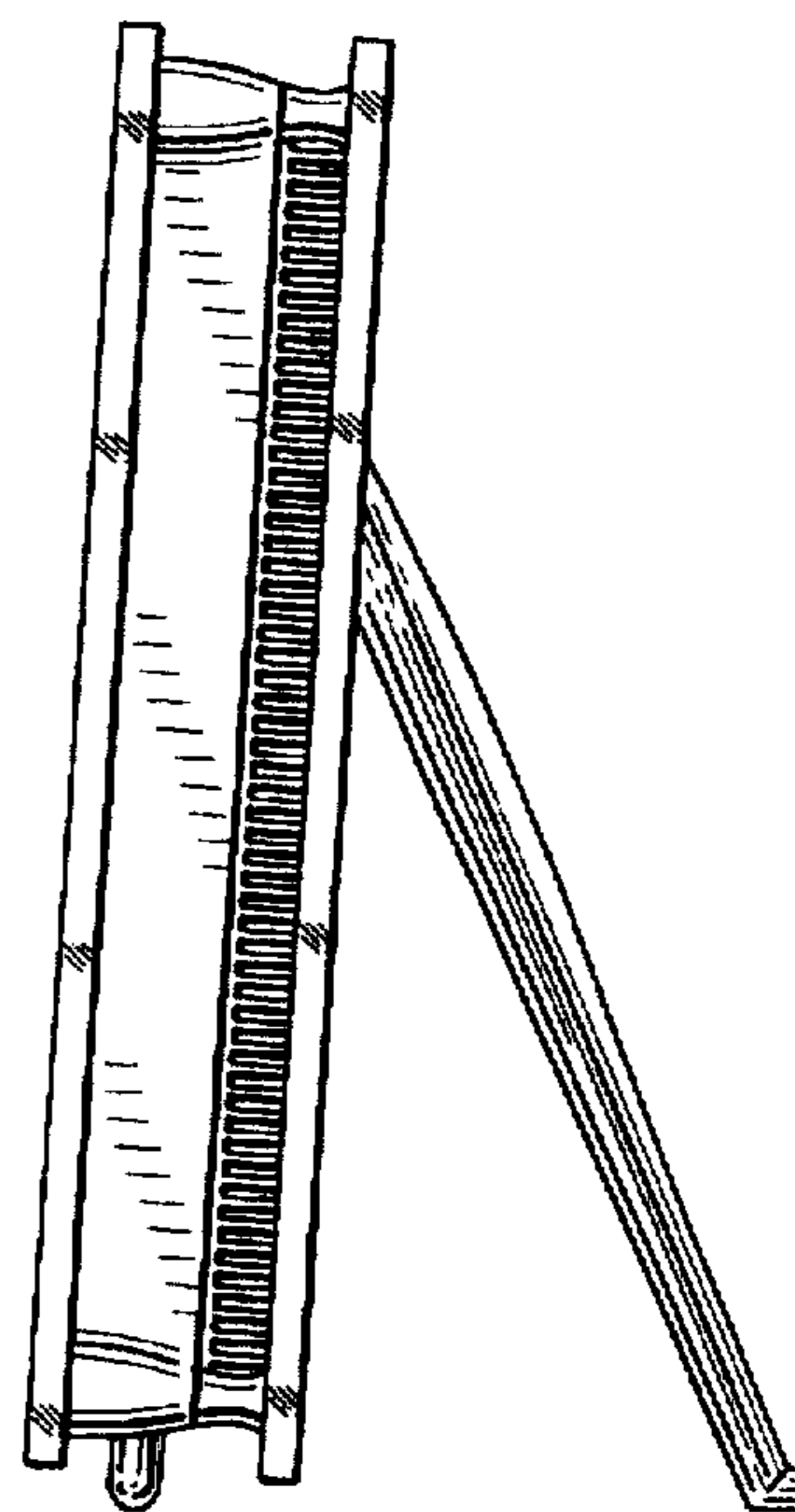
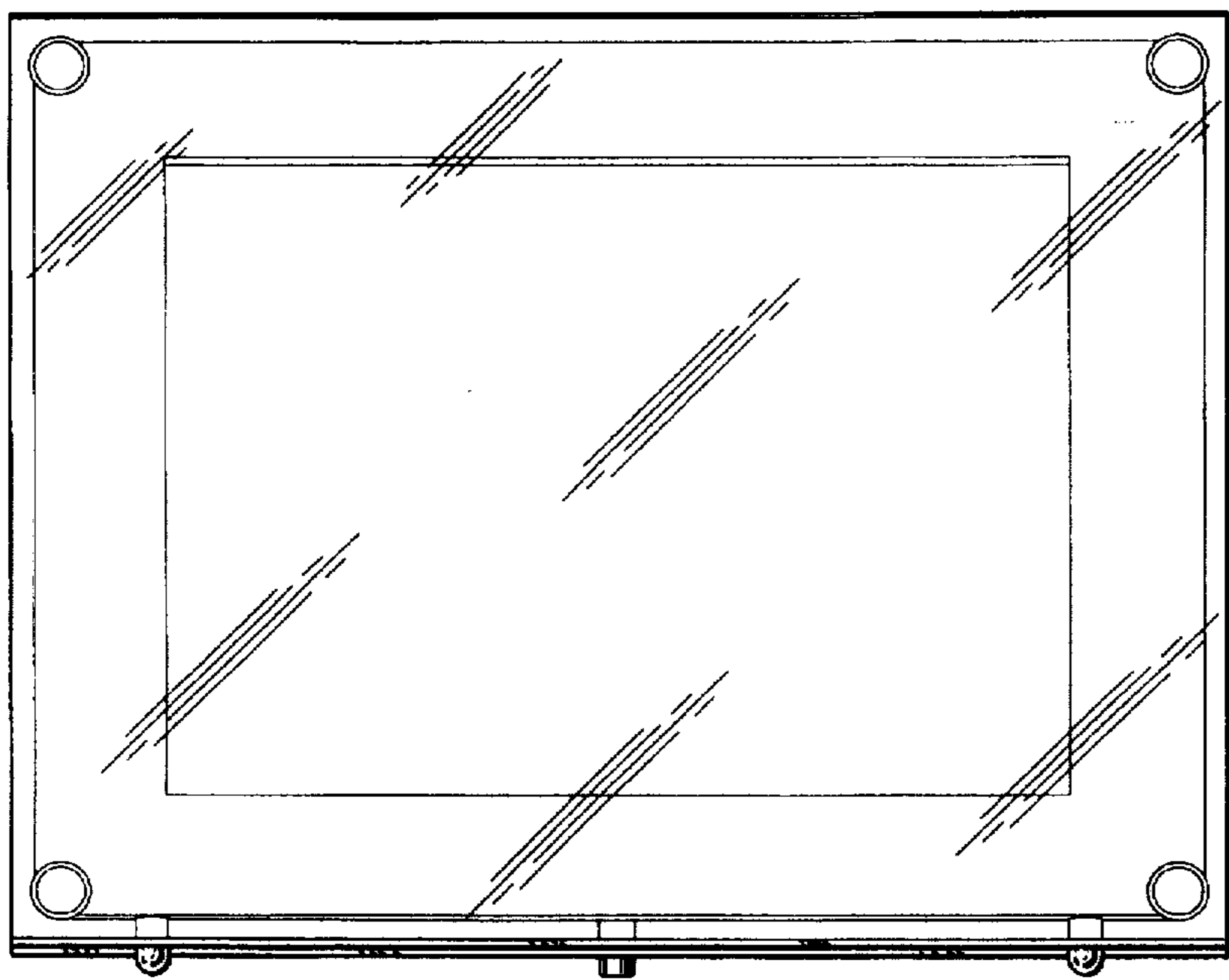

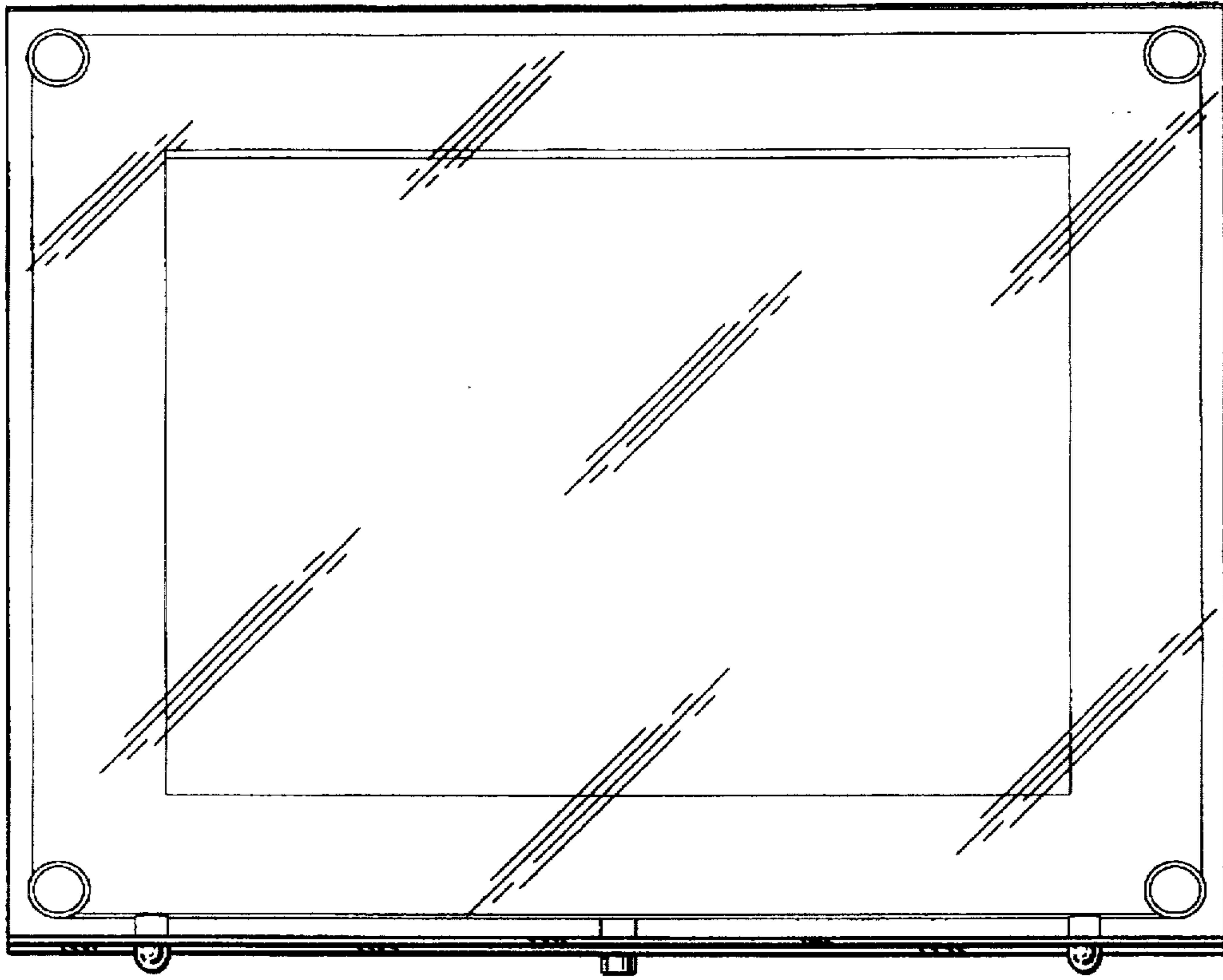

FIG. 1

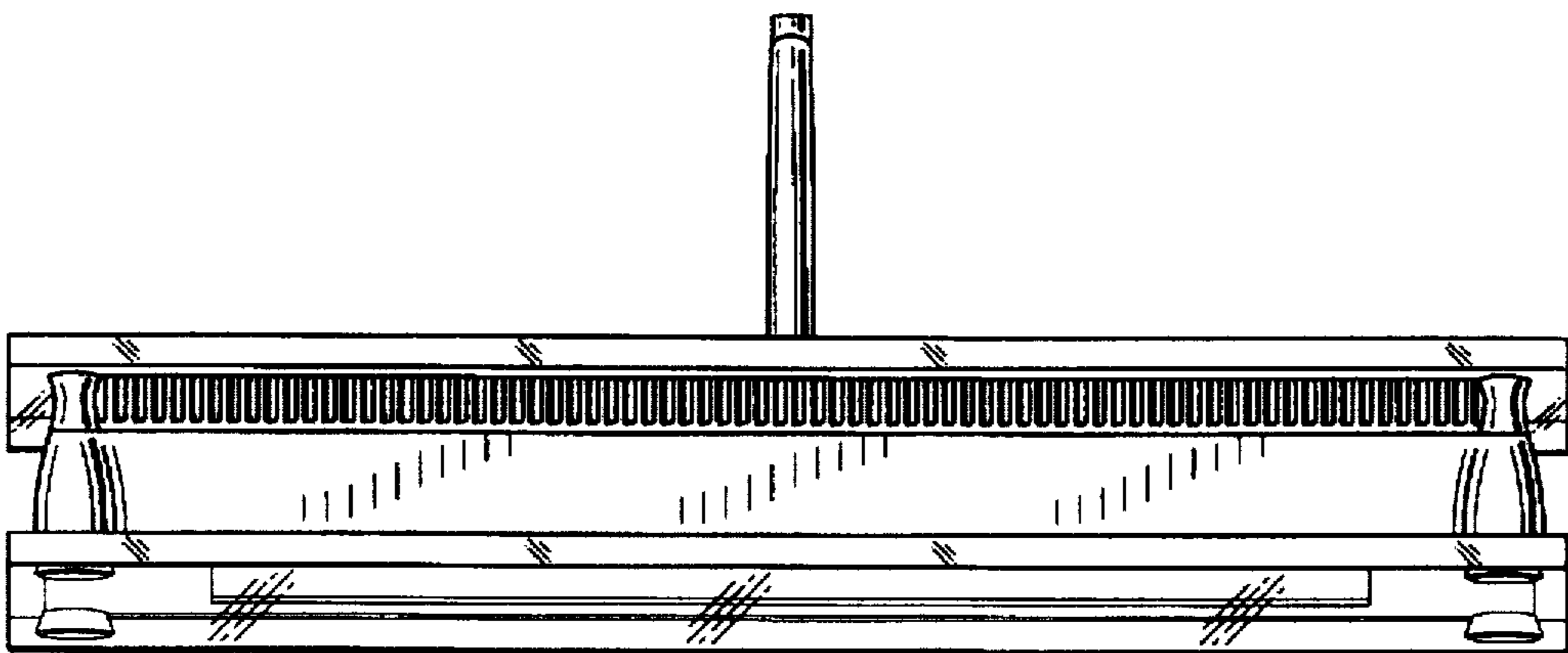

FIG. 2

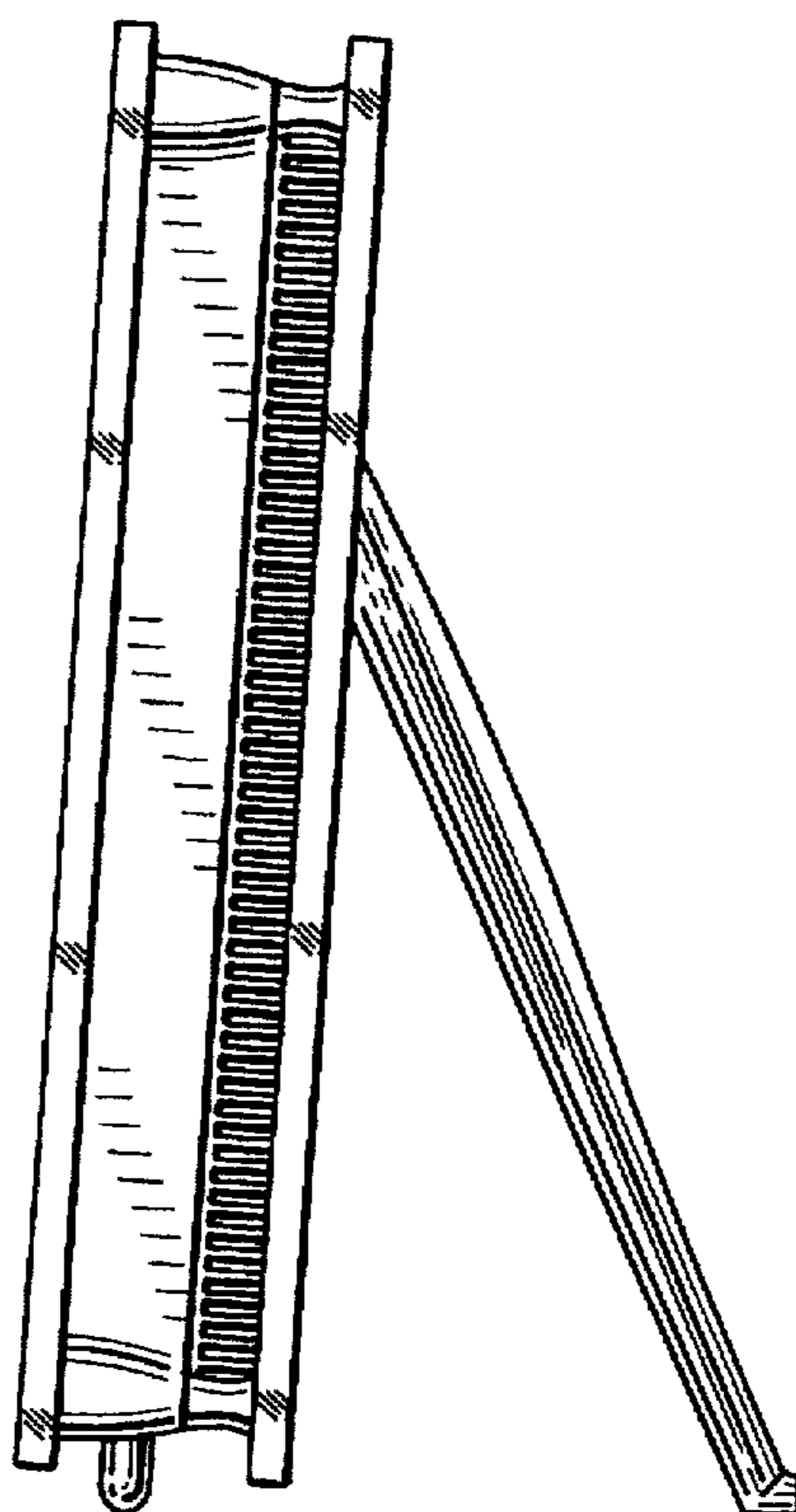

FIG. 3

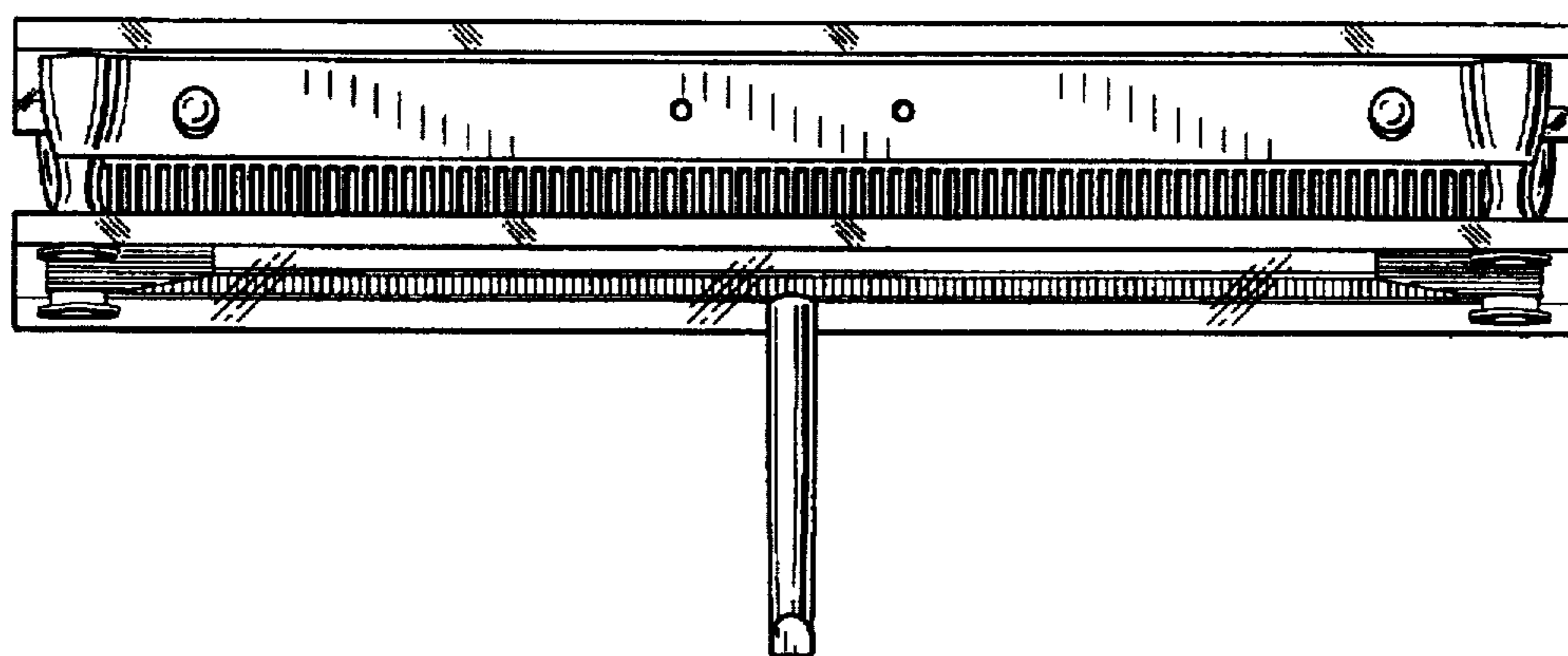

FIG. 4

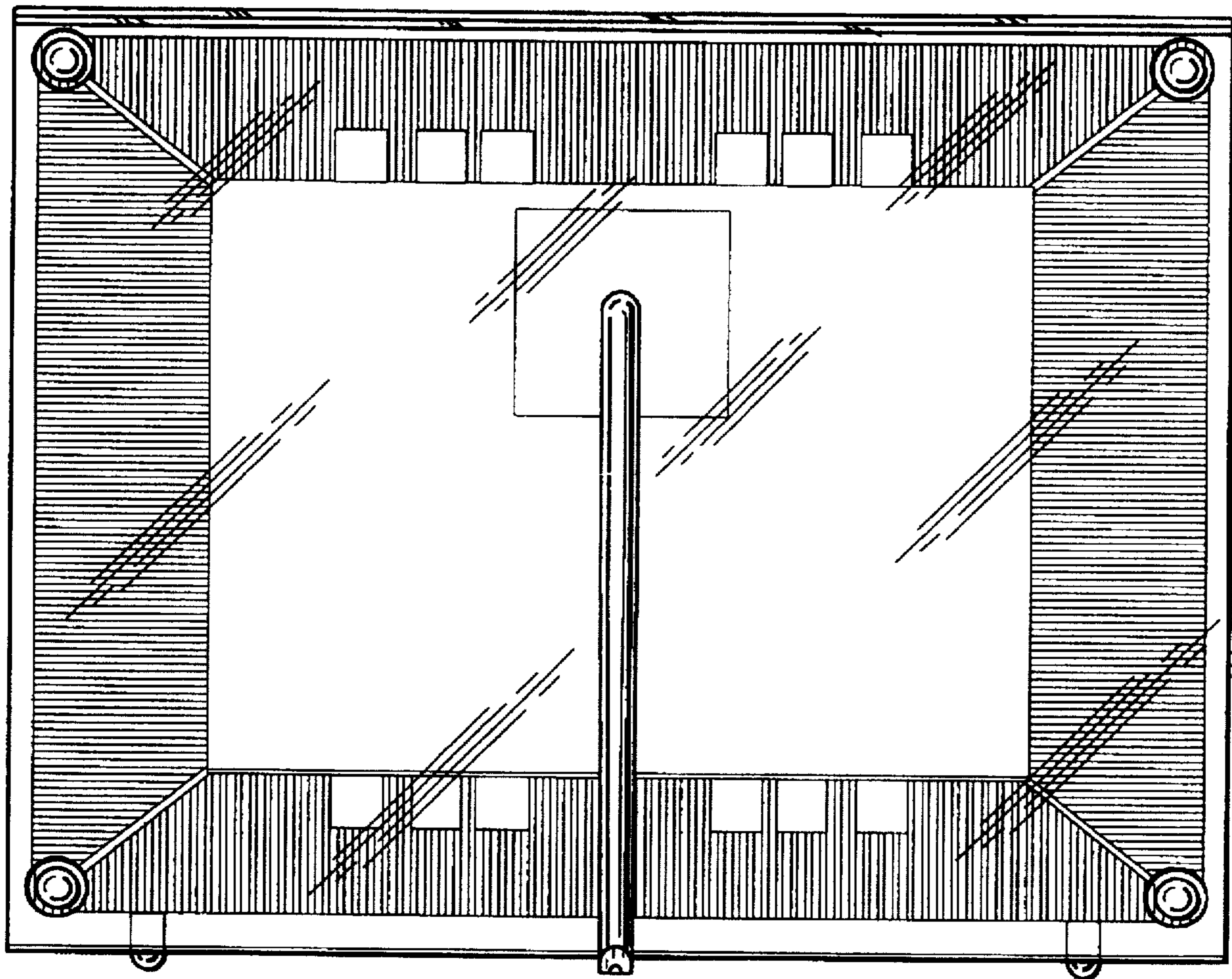

FIG. 5