



US00D387763S

United States Patent [19]
Harrington et al.

[11] **Patent Number: Des. 387,763**

[45] **Date of Patent: **Dec. 16, 1997**

[54] **SELECTIVE CALL RECEIVER**

[75] **Inventors: Scott Allen Harrington; Stephen Wilson Braun, both of Atlanta, Ga.; Robert Scott Flippo, Deerfield Beach, Fla.; Bradley Mark Wilkinson, Decatur, Ga.**

[73] **Assignee: Motorola, Inc., Schaumburg, Ill.**

[**] **Term: 14 Years**

[21] **Appl. No.: 66,824**

[22] **Filed: Feb. 24, 1997**

[51] **LOC (6) Cl. 14-03**

[52] **U.S. Cl. D14/191**

[58] **Field of Search D14/124, 188, D14/191, 192, 299; 340/311.1; 455/38.1-38.4, 90, 92, 100, 128, 344**

[56] **References Cited**

U.S. PATENT DOCUMENTS

D. 369,807 5/1996 Lloyd et al. D14/191

D. 374,669 10/1996 Suzuki et al. D14/198 X
D. 375,957 11/1996 Nagai D14/191
D. 377,019 12/1996 Nagano et al. D14/191

Primary Examiner—Sandra L. Morris
Assistant Examiner—Nanda Bondade
Attorney, Agent, or Firm—Gregg Rasor

[57] **CLAIM**

The ornamental design for a selective call receiver, as shown and described.

DESCRIPTION

FIG. 1 is a front elevational view of a selective call receiver showing our new design;
FIG. 2 is a top plan view thereof;
FIG. 3 is a rear elevational view thereof;
FIG. 4 is a right side elevational view thereof;
FIG. 5 is a left side elevational view thereof;
FIG. 6 is a bottom plan view thereof; and,
FIG. 7 is a top, front, and right side perspective view thereof.

1 Claim, 3 Drawing Sheets

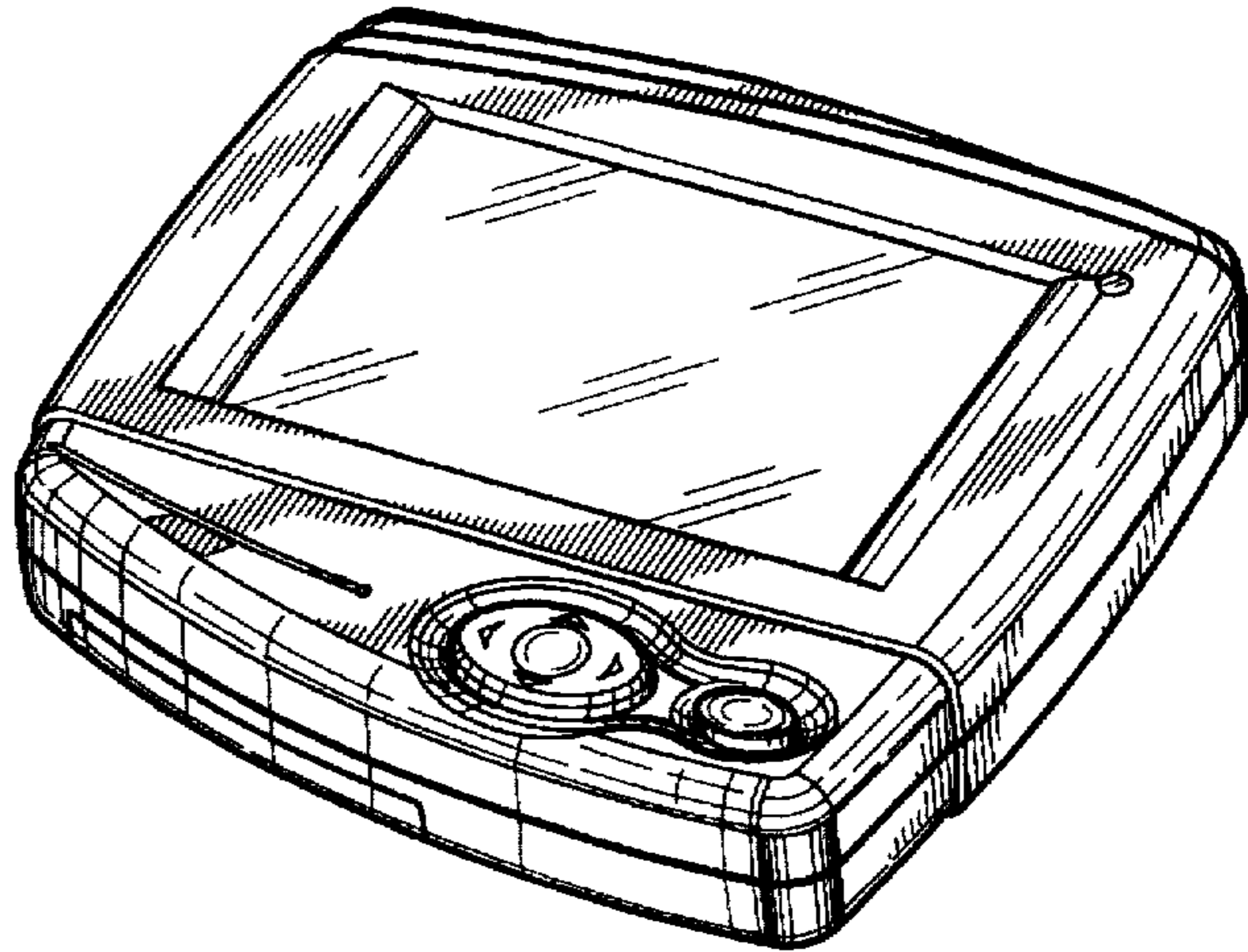
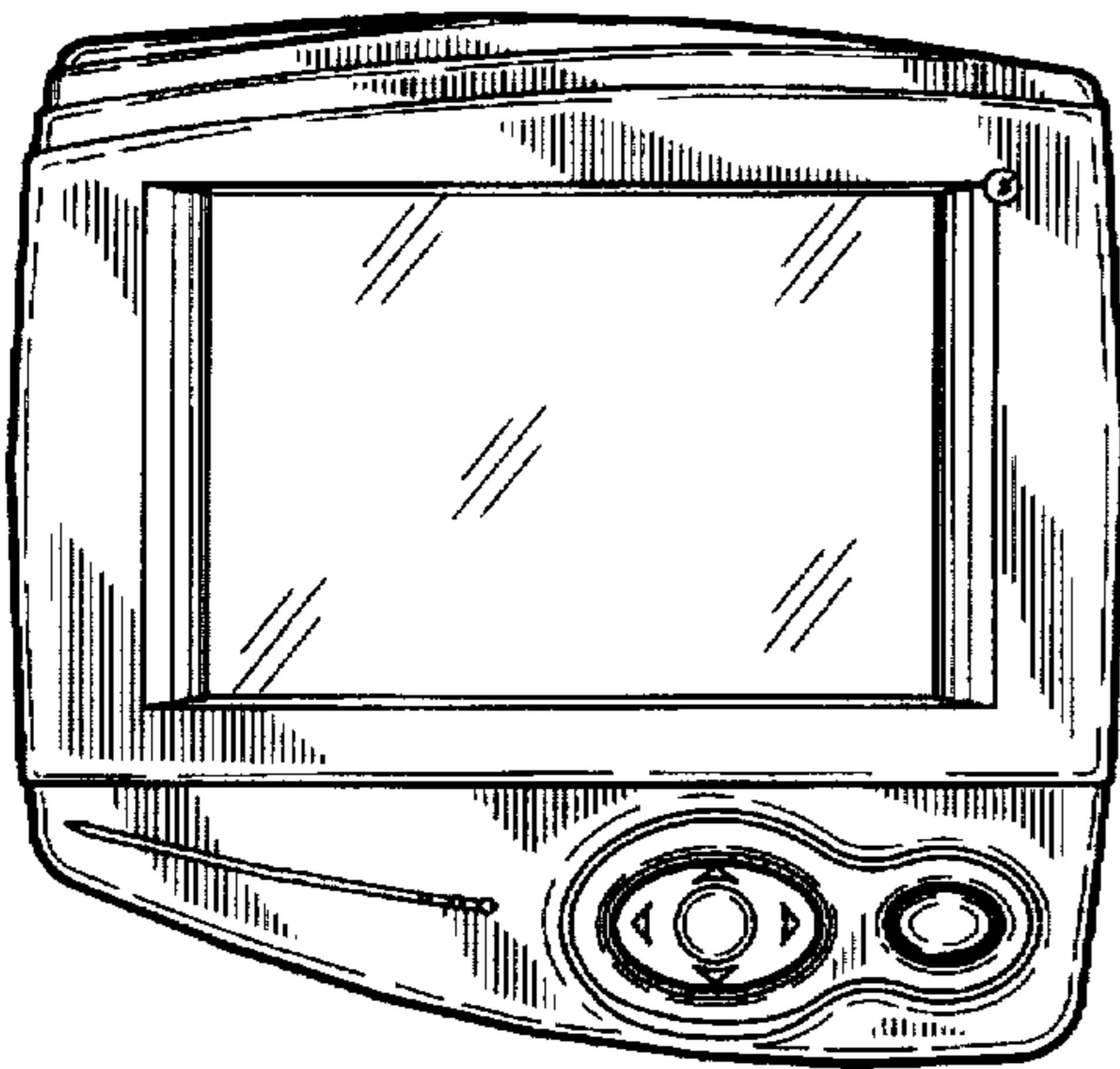

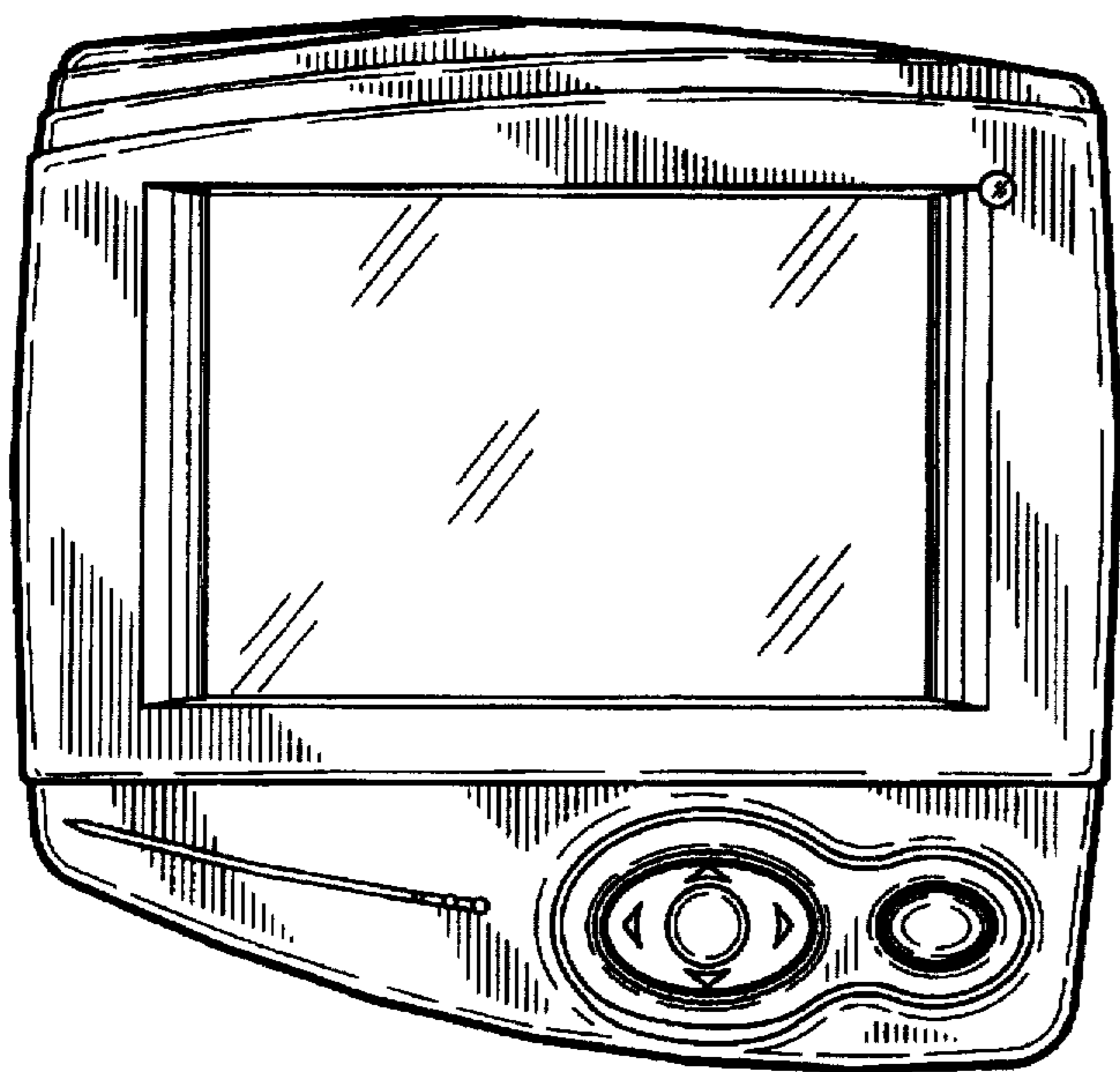

FIG. 1

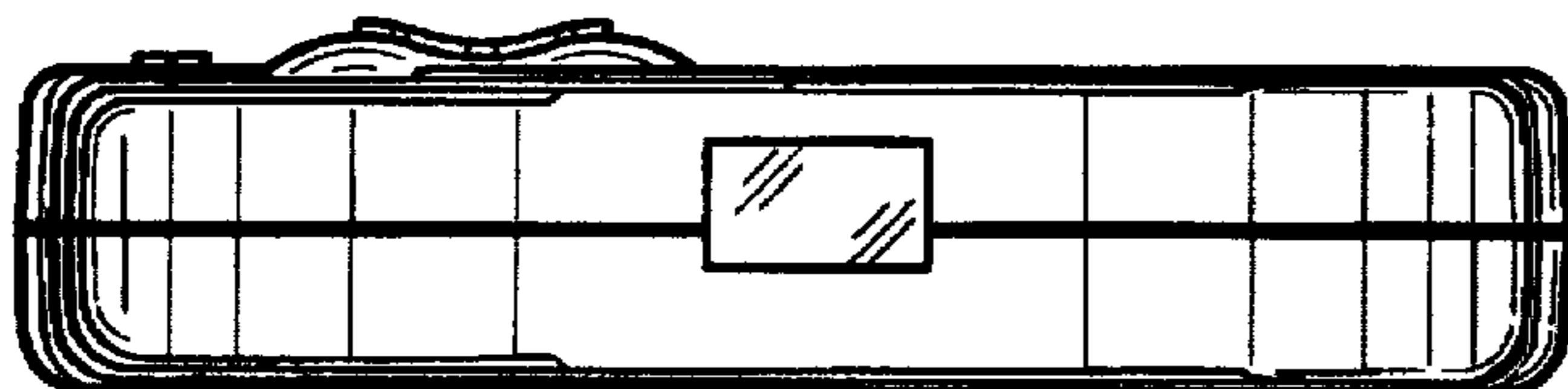

FIG. 2

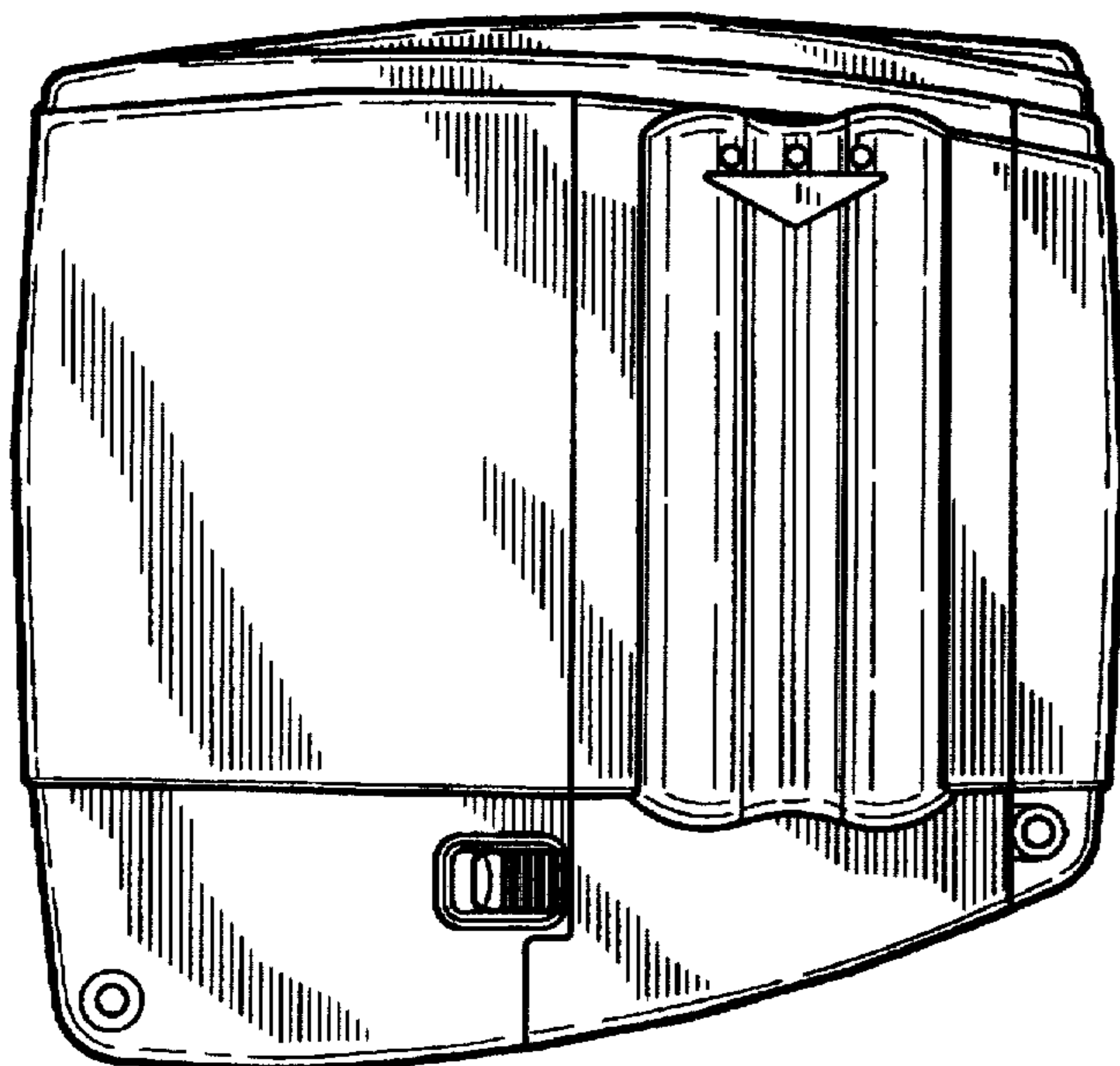

FIG. 3



FIG. 4

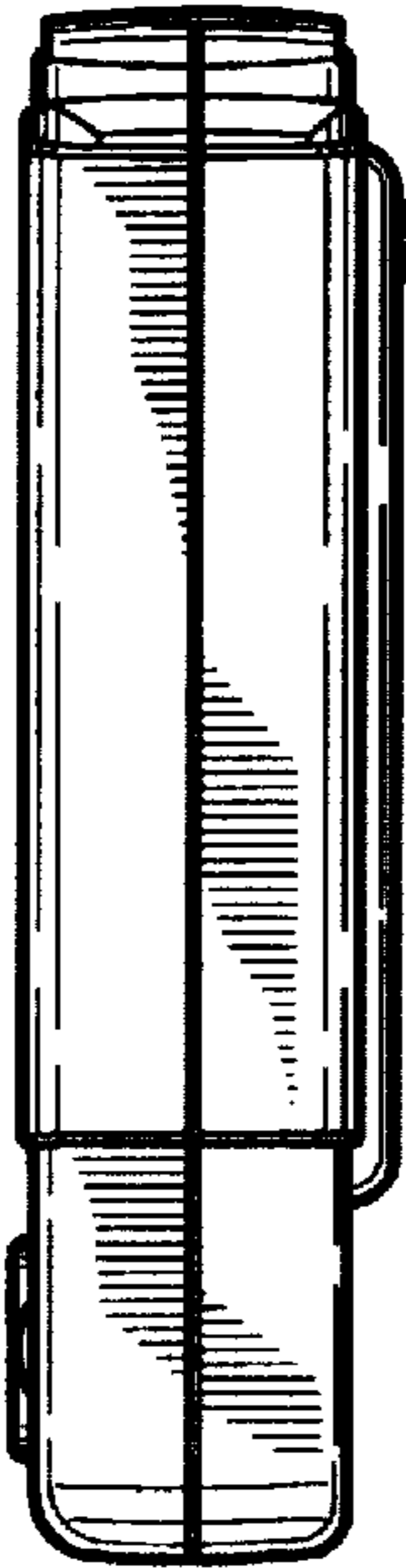

FIG. 5

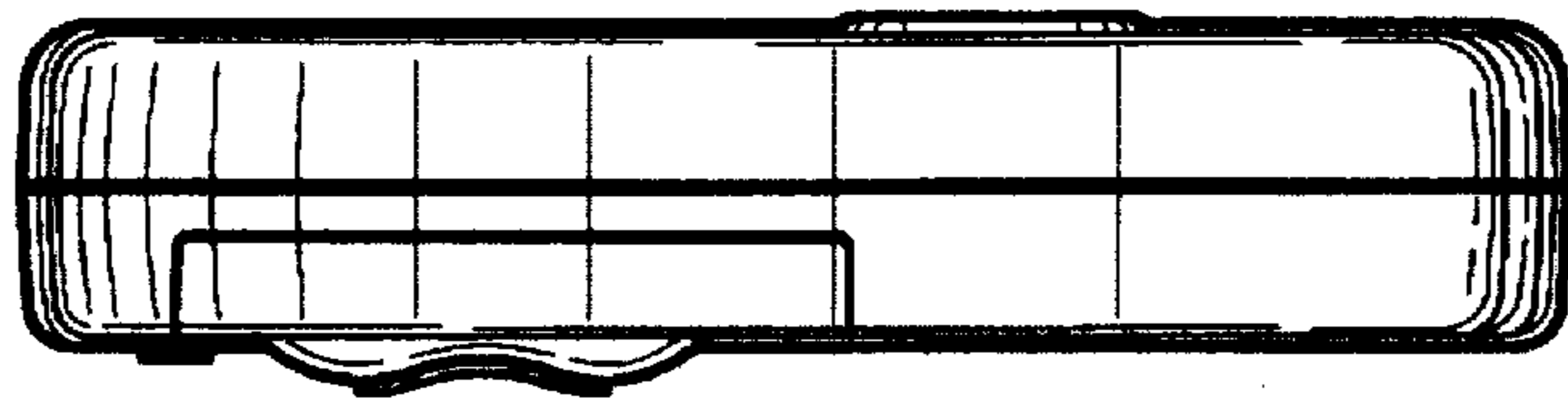

FIG. 6

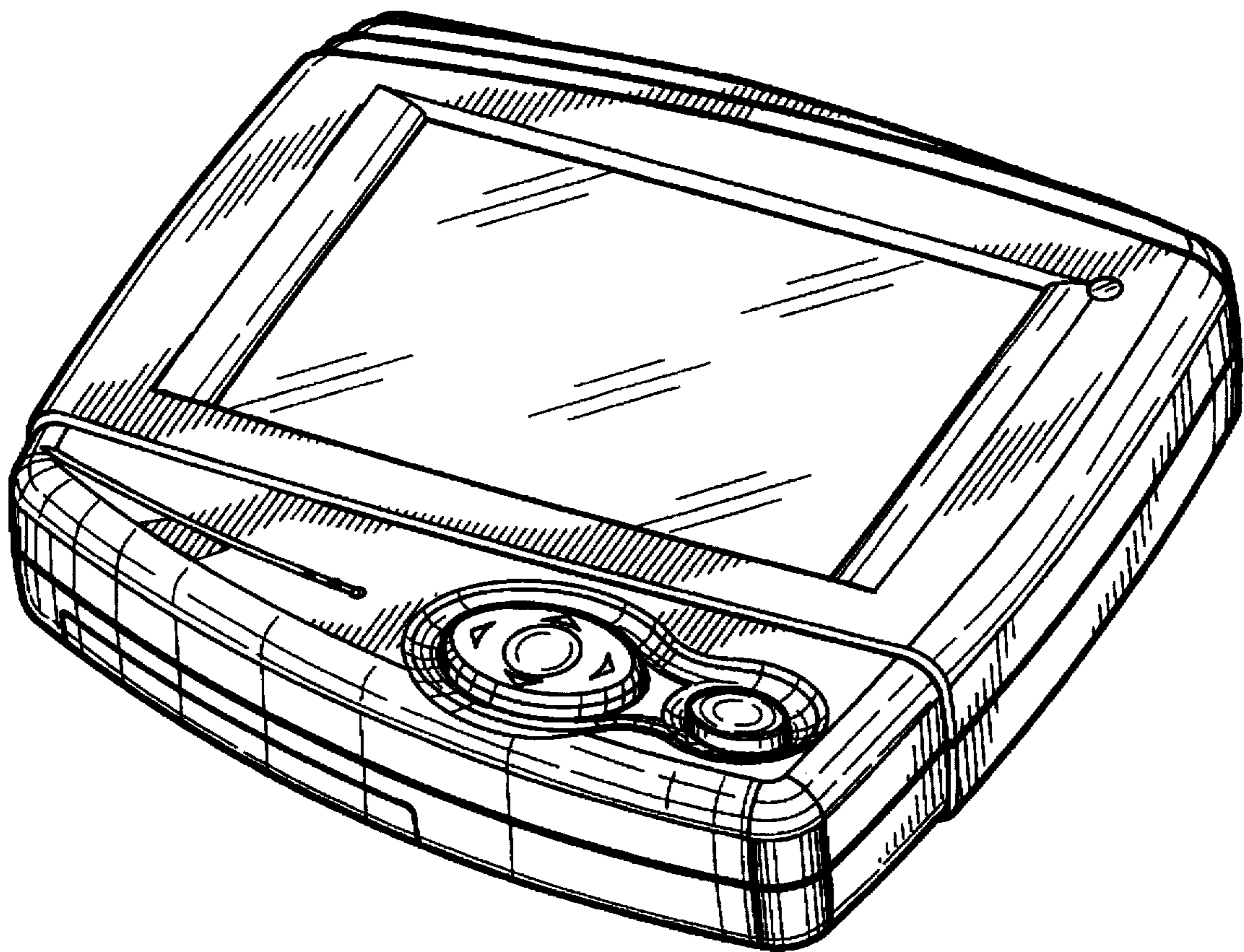

FIG. 7