



US00D387704S

United States Patent [19]

Berti

[11] Patent Number: Des. 387,704

[45] Date of Patent: **Dec. 16, 1997

[54] LIQUID-DISPENSING SCRUB BRUSH

[75] Inventor: Enzo Berti, Dolo/Venice, Italy

[73] Assignee: The Libman Company, Arcola, Ill.

[**] Term: 14 Years

[21] Appl. No.: 60,398

[22] Filed: Sep. 27, 1996

[51] LOC (6) Cl. 04-01

[52] U.S. Cl. D4/114; D4/137; D32/45

[58] Field of Search D4/114, 116, 118, D4/132, 137; D9/338; D32/40, 42, 45; 15/143.1, 159.1, 209.1, 244.1; 401/136, 139, 152, 156, 183-185, 196, 206-207, 261, 264, 266

[56] **References Cited**

U.S. PATENT DOCUMENTS

D. 252,250	7/1979	Hobbs	D32/45
D. 320,490	10/1991	Andrew, III et al.	D32/45
D. 330,788	11/1992	Libman	D32/45
D. 349,193	8/1994	Sloan et al.	D4/118
3,187,365	6/1965	Paul	401/184

4,148,318	4/1979	Meyer	401/196 X
4,609,301	9/1986	Benarrouch	401/196

OTHER PUBLICATIONS

O-Cedar/Vining Household Products Co. Product Catalog, Aug. 1994; Dishwasher-Item 345, p. CO-09.

Primary Examiner—Alan P. Douglas
Assistant Examiner—Lavone D. Tabor
Attorney, Agent, or Firm—Marshall, O'Toole, Gerstein, Murray & Borun

[57] **CLAIM**

The ornamental design for a liquid-dispensing scrub brush, as shown and described.

DESCRIPTION

FIG. 1 is a perspective view of a liquid-dispensing scrub brush in accordance with the present invention; FIG. 2 is a front view of the scrub brush; FIG. 3 is a left-side view, the right-side view being a mirror image; FIG. 4 is a back view; FIG. 5 is a top view; and, FIG. 6 is a bottom view.

1 Claim, 3 Drawing Sheets

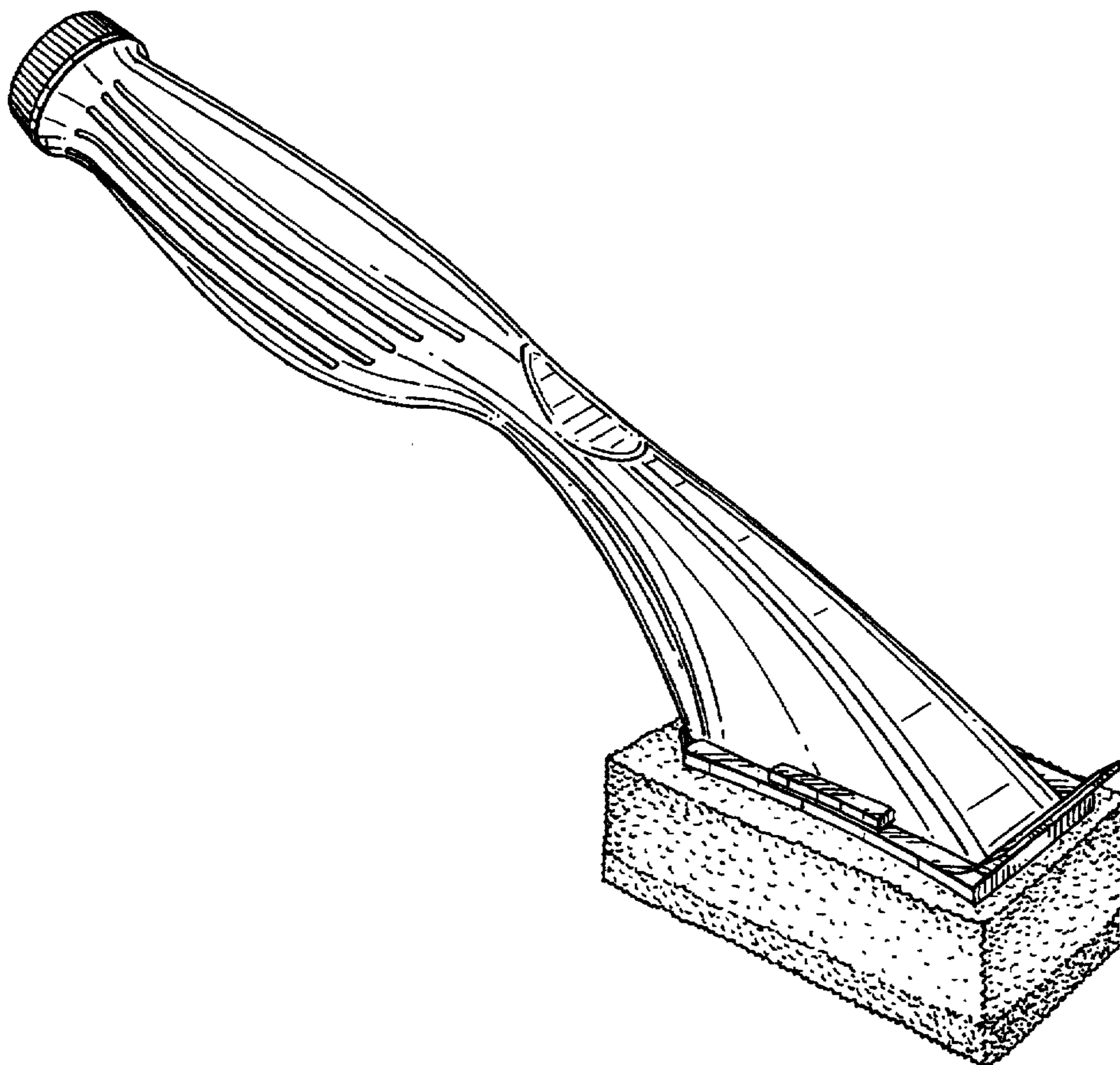

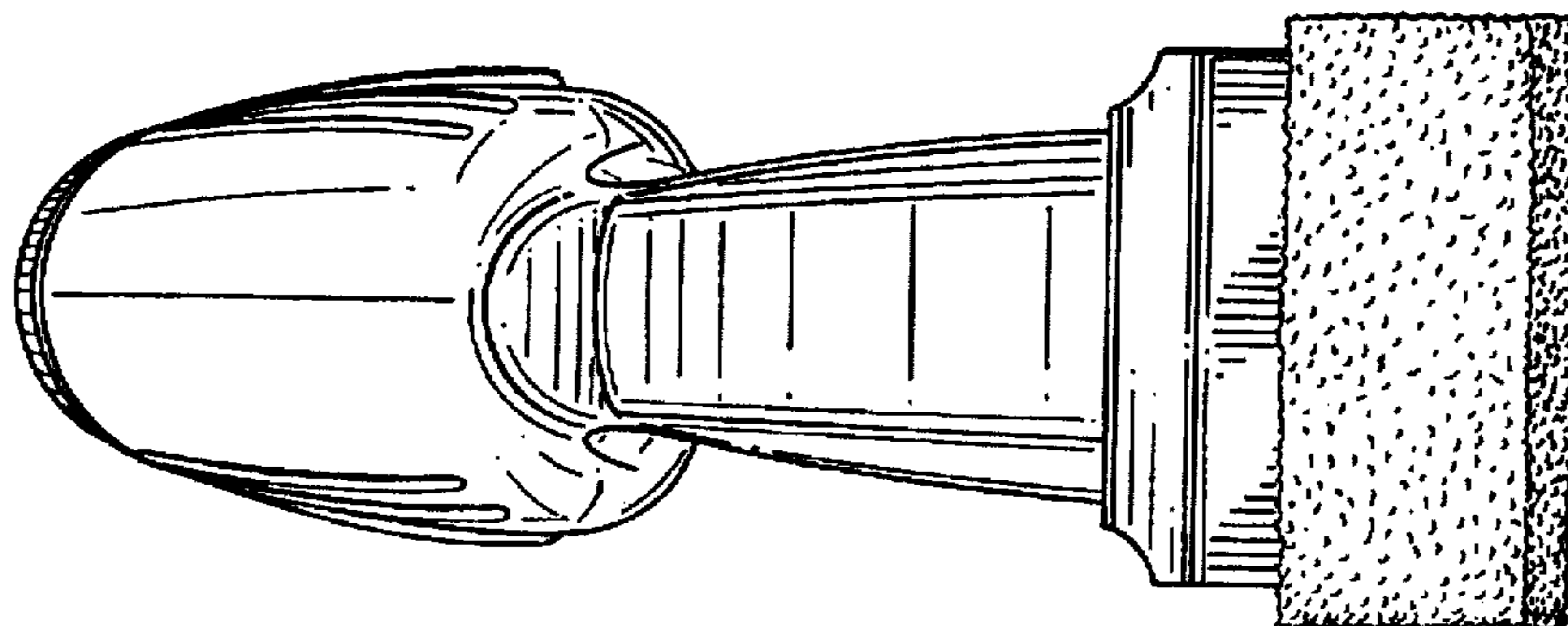

FIG. 2

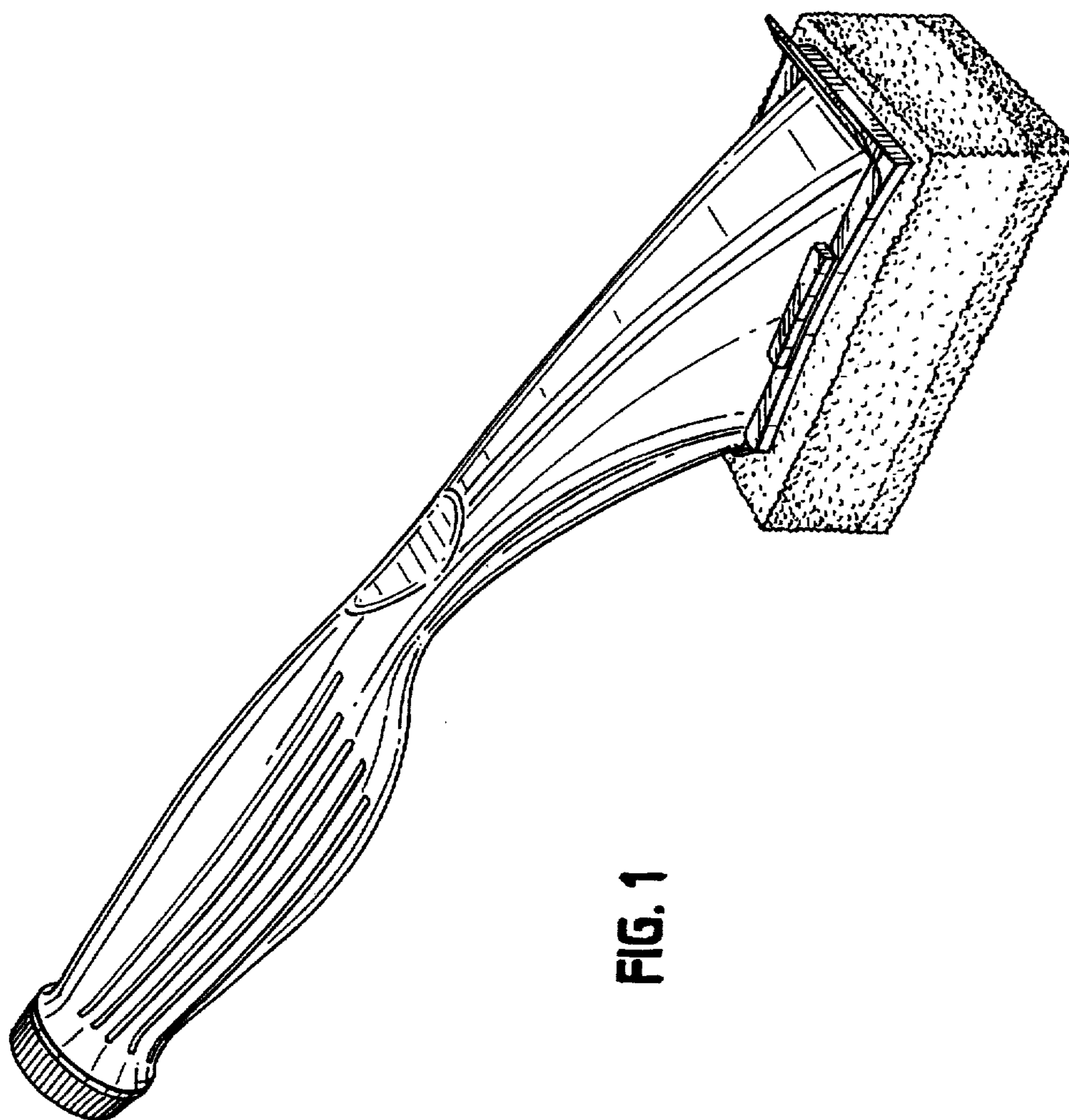
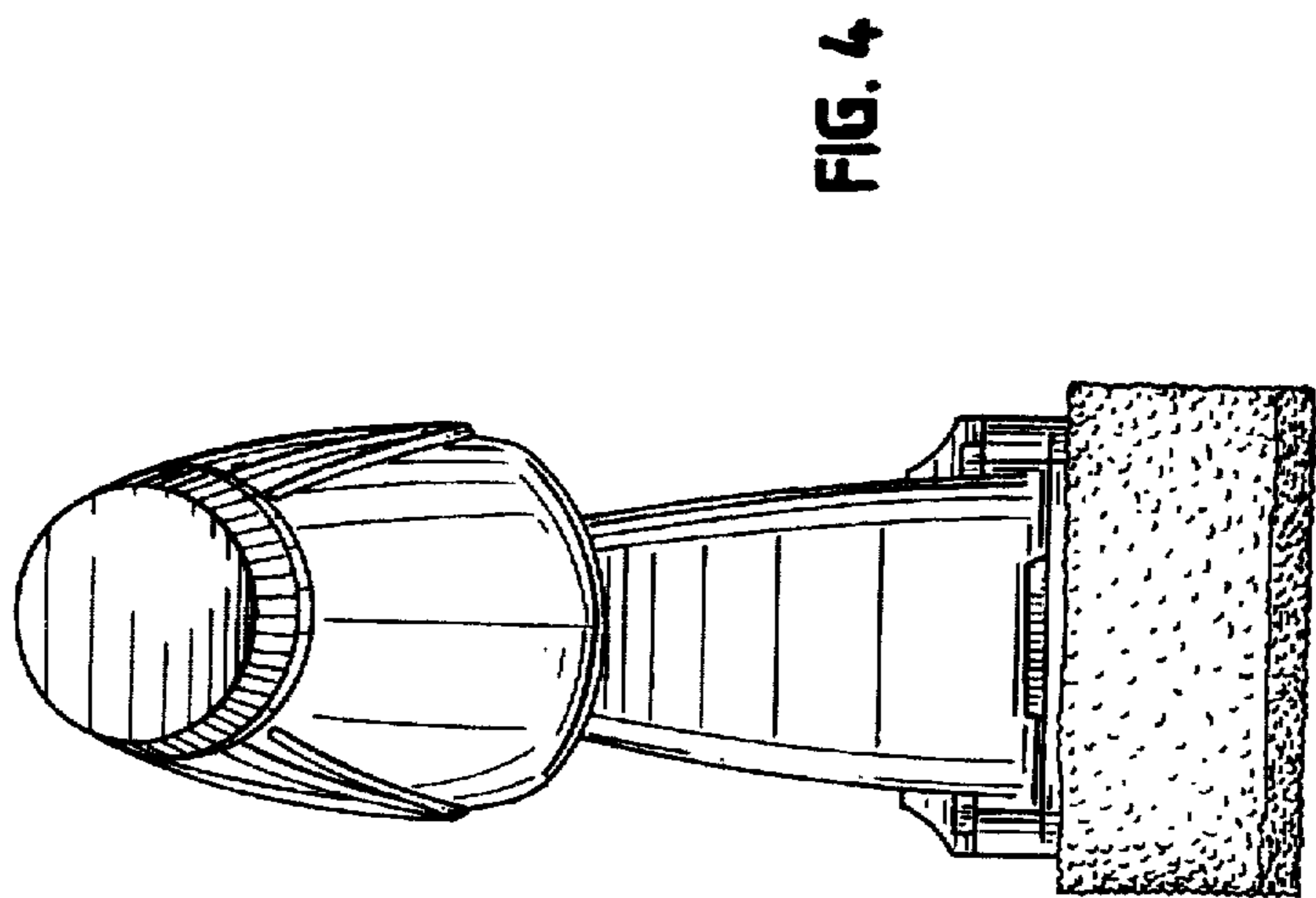
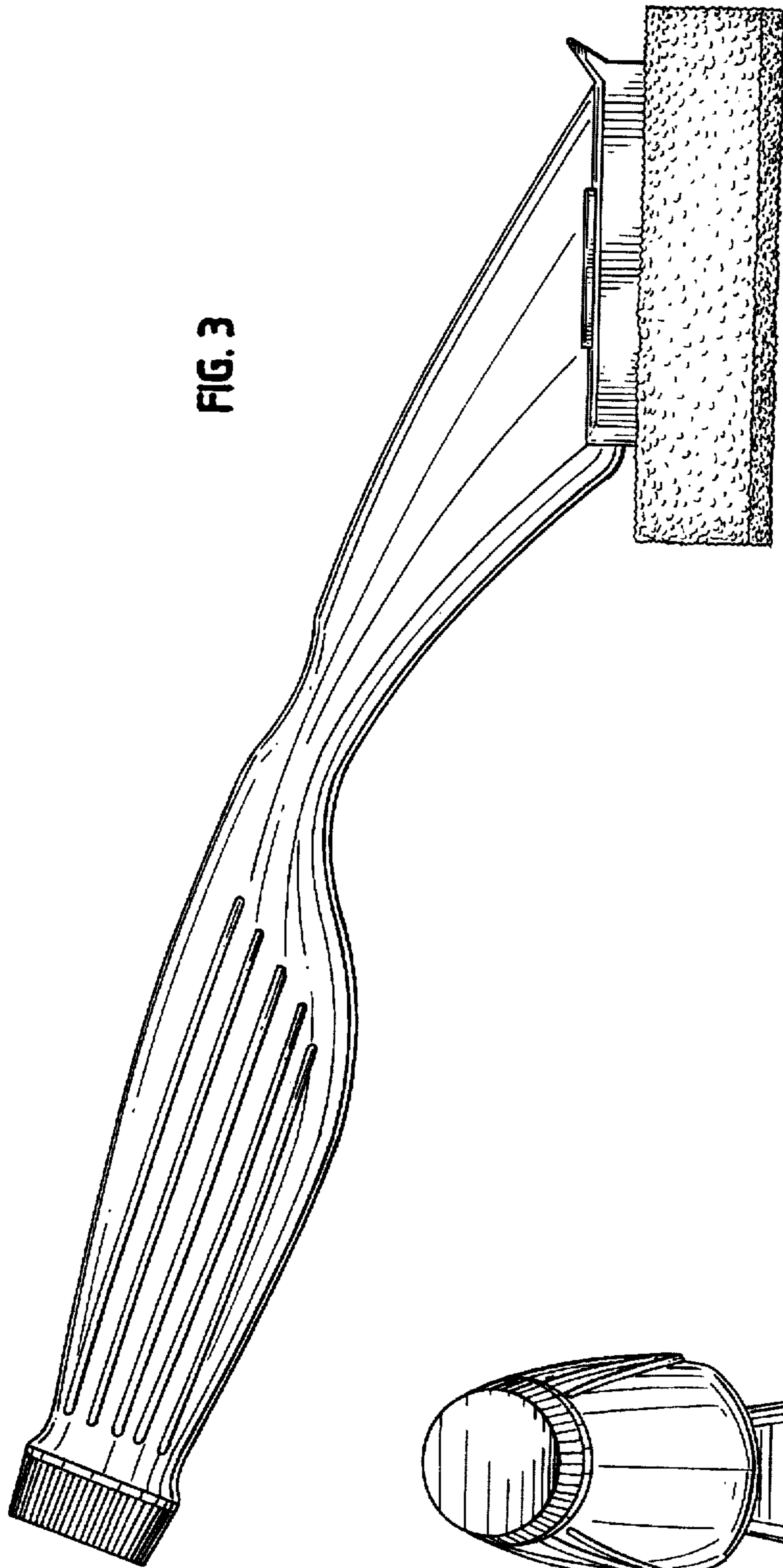

FIG. 1



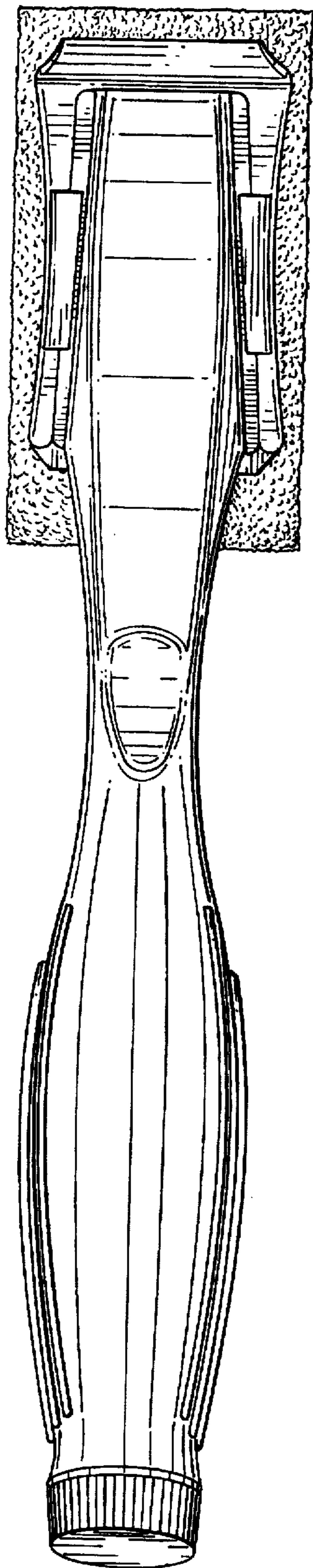

FIG. 5

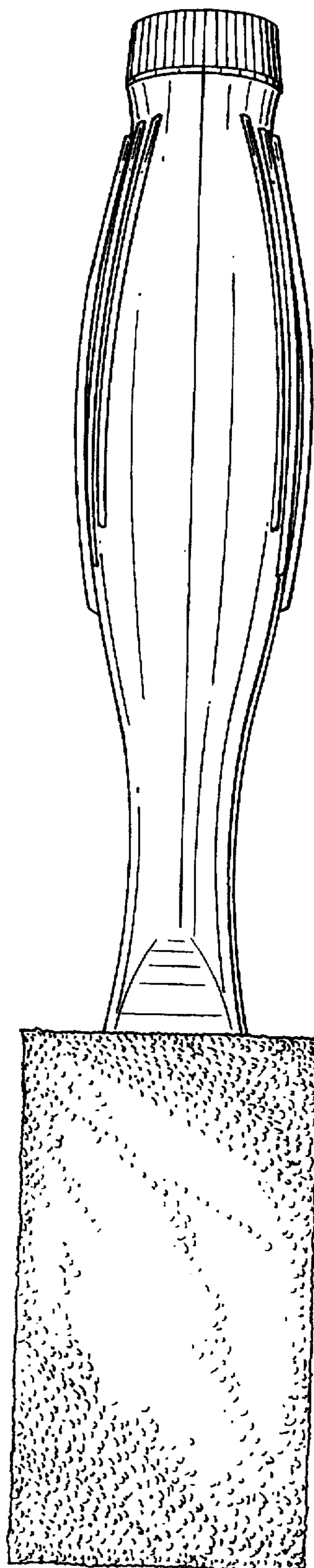

FIG. 6